

Urological Solutions

You're there for your patients. We're here for you.



Your path to
comprehensive
urology solutions



The highest quality products

We offer you a comprehensive range of clinically proven products, including:

- Urinary catheter trays designed by nurses that align clinical behaviour with evidence-based practices
- Various intermittent and Foley catheters to fit your patients' needs
- Urological drainage solutions for use during the hospital stay or for chronic conditions

CAUTI prevention

In order to help maintain patients' health, we are dedicated to preventing catheter-associated urinary tract infections (CAUTIs) as much as possible. The Robert Koch Institute (RKI) recommends different tools to prevent CAUTIs. These include:

- Stringent protocols for catheterisation to help reduce unnecessary use
- Product standardisation
- Maintenance of catheter sterility
- Timely removal of the catheter.¹

Table of contents

Prevent CAUTIs	3
Urinary catheters	7
Urine drainage systems	16
Leg bags	26
Paediatrics	28
Irrigation syringes	30
Gastroenterological products	31



**Prevention
is better
than a cure**

Solutions to help prevent CAUTIs

CAUTIs are one of the most common healthcare-associated infections (HAIs). CAUTI protocols exist, but with so many competing priorities, compliance with best practices is often inconsistent. These infections are most likely caused by bacteria entering the bladder during catheter insertion, or due to a disruption in the closed drainage system.

The daily incidence rate of patients developing a CAUTI lies between 3 and 10 per cent. After an indwelling time of 30 days, the majority of patients will experience bacteriuria or bacteria in their urine. In general, 80 per cent of nosocomial urinary tract infections are catheter-associated.¹

Using sterile (EO) catheter exchange kits, paired with consistent best practices, can lower the infection rate amongst patients when placing or changing urinary catheters. With these kits, Medline aims to be part of a CAUTI-reducing solution that is customised for your facility's specific needs.

Catheter exchange kits

S-010000 components:

- 1 urine collection tray, plastic
- 6 gauze swabs, plum-sized
- 2 gauze compresses, 7.5 x 7.5 cm
- 1 pair of forceps
- 1 drape with slit opening, 60 x 60 cm, waterproof
- 1 cover drape, 60 x 60 cm, waterproof
- 1 pair of examination gloves, latex, medium, powder-free in paper
- 1 wrap, 60 x 60 cm, waterproof



S-020000-N components:

- 1 urine collection tray, plastic
- 6 gauze swabs, plum-sized
- 2 gauze compresses, 7.5 x 7.5 cm
- 2 pairs of forceps
- 1 drape with slit opening, 60 x 60 cm, waterproof
- 1 pair of examination gloves, nitrile, large, powder-free in paper
- 1 wrap, 60 x 60 cm, waterproof



S-030000 components:

- 1 kidney dish, plastic
- 1 swab bowl, plastic
- 5 gauze swabs, plum-sized
- 2 gauze compresses, 7.5 x 7.5 cm
- 1 pair of forceps
- 1 drape with slit opening, 60 x 60 cm, waterproof
- 1 pair of examination gloves, latex, medium, powder-free in paper
- 1 wrap, 60 x 60 cm, waterproof

**S-030000-N components:**

- 1 kidney dish, plastic
- 1 swab bowl, plastic
- 5 gauze swabs, plum-sized
- 2 gauze compresses, 7.5 x 7.5 cm
- 1 pair of forceps
- 1 drape with slit opening, 60 x 60 cm, waterproof
- 1 pair of examination gloves, nitrile, large, powder-free in paper
- 1 wrap, 60 x 60 cm, waterproof

**S-040000 components:**

- 1 urine collection tray, plastic
- 4 gauze swabs, plum-sized
- 2 gauze compresses, 7.5 x 7.5 cm
- 2 pairs of forceps
- 1 drape with slit opening, 50 x 50 cm, waterproof
- 1 pair of examination gloves, latex, medium, powder-free in paper
- 1 wrap, 60 x 60 cm, waterproof

**S-050000 components:**

- 1 kidney dish, plastic
- 1 swab bowl, plastic
- 6 gauze swabs, plum-sized
- 1 gauze compresses, 10 x 10 cm
- 2 pairs of forceps
- 1 drape with slit opening, 50 x 50 cm, waterproof
- 1 pair of examination gloves, latex, medium, powder-free in paper
- 1 work drape, 60 x 60 cm, waterproof
- 1 wrap, 60 x 60 cm, waterproof

**S-060000 components:**

- 1 urine collection tray, plastic
- 5 gauze swabs, plum-sized
- 5 gauze compresses, 7.5 x 7.5 cm
- 1 pair of forceps
- 1 drape with slit opening, 50 x 50 cm, waterproof
- 1 pair of examination gloves, latex, large, powder-free in paper
- 1 examination glove, latex, medium, powder-free, folded cuff
- 1 wrap, 60 x 60 cm, waterproof



S-060000-N components:

- 1 urine collection tray, plastic
- 5 gauze swabs, plum-sized
- 5 gauze compresses, 7.5 x 7.5 cm
- 1 pair of forceps
- 1 drape with slit opening, 50 x 50 cm, waterproof
- 1 pair of examination gloves, nitrile, large, powder-free in paper
- 1 examination glove, nitrile, medium, powder-free, folded cuff
- 1 wrap, 60 x 60 cm, waterproof

**S-070000 components:**

- 1 kidney dish, plastic
- 1 swab bowl, plastic
- 4 gauze swabs, plum-sized
- 4 gauze compresses, 7.5 x 7.5 cm
- 1 pair of forceps
- 1 drape with slit opening, 50 x 50 cm, waterproof
- 1 pair of examination gloves, latex, medium, powder-free in paper
- 1 wrap, 60 x 60 cm, waterproof

**S-080000 components:**

- 1 urine collection tray, plastic
- 6 gauze swabs, egg-sized
- 2 gauze compresses, 7.5 x 7.5 cm
- 2 pairs of forceps
- 1 drape with slit opening, 60 x 60 cm, waterproof
- 1 pair of examination gloves, latex, medium, powder-free in paper
- 1 wrap, 60 x 60 cm, waterproof
- 1 Glyco-SID®, 10 ml

**S-090000 components:**

- 1 urine collection tray, plastic
- 6 gauze swabs, plum-sized
- 1 pair of forceps
- 1 drape with slit opening, 60 x 60 cm, waterproof
- 1 pair of examination gloves, vinyl, large, powder-free, folded cuff
- 1 wrap, 60 x 60 cm, waterproof
- 1 Glyco-SID®, 10 ml

**UROKIT001 components:**

- 1 tray, plastic
- 1 fenestrated drape, 75 x 90 cm, fen. 9 x 12cm
- 5 gauze compresses 7.5 x 7.5 cm
- 1 pair of kocher forceps
- 1 wrap, 60 x 60 cm, waterproof
- 1 Prefilled syringe with aqua 20 ml
- 1 lubricating jelly 5g



Medline CareSets

KER70700 components:

- 1 drape, 75 x 90 cm
- 1 fenestrated drape 75 x 90 cm, fen. 9 x 12 cm
- 1 syringe, 20 ml
- 1 ampoule with distilled water, 20 ml
- 1 lubricating jelly, 5 g
- 1 plastic Kocher forceps
- 5 non-woven swabs, 7.5 x 7.5 cm
- 1 medium, rigid blister pack



KER70022B-02 components:

- 1 drape, 75 x 90 cm
- 1 fenestrated drape 75 x 90 cm, fen. 9 x 12 cm
- 2 pre-filled syringes with distilled water, 10 ml
- 1 pre-filled syringes lubricating jelly, 5 g
- 1 plastic Kocher forceps
- 5 non-woven swabs, 7.5 x 7.5 cm
- 1 medium, rigid blister pack



Do our existing CareSets meet your specific requirements?
Contact us for a customised Set, including components you require for your patients' catheterisation procedure.

**You're there
for your
patients.
We're here
for you.**

UROSID[®]

**Quality
Reliability
Safety**

Pre-Connected Closed Urine Drainage System

The pre-connected urinary catheter and closed urinary drainage system ensure a non-touch technique, reduce handling steps, and help standardise the procedure. The catheter is pre-attached to the UROSID® 2000 S urine drainage bag which helps to minimise contamination.

The indwelling time of the Pre-connected System is up to 14 days, whilst the silicone Foley catheter can remain in place for up to 30 days.

Benefits and Features

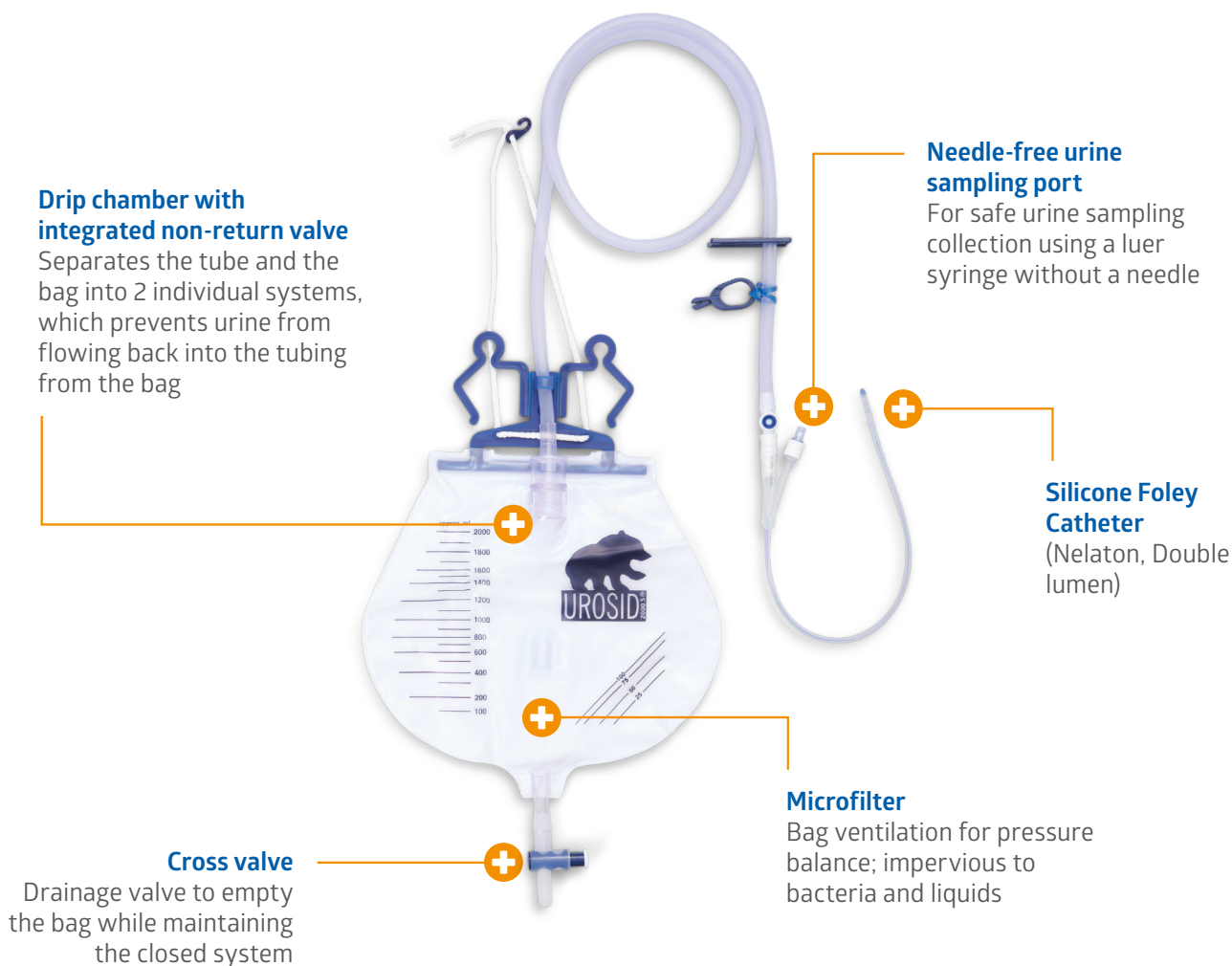

REF 690212-N-SFxx

References	Silicone Foley Catheter				Closed Urine Drainage System			
	Size (CH)	Length (cm)	Balloon Volume (ml)	Colour	Volume Bag (ml)	Tubing Length (cm)	Cross Valve	Units (ea)
690212-N-SF12	12	40	10	White	2000	120	Vertical	20
690212-N-SF14	14	40	10	Green	2000	120	Vertical	20
690212-N-SF16	16	40	10	Orange	2000	120	Vertical	20
690212-N-SF18	18	40	10	Red	2000	120	Vertical	20
690212-N-SF20	20	40	10	Yellow	2000	120	Vertical	20
690212-N-SF22	22	40	10	Purple	2000	120	Vertical	20

Urinary catheters



Solutions to help prevent CAUTI

Urinary catheterisation facilitates the draining of the bladder and collection of urine through intermittent or indwelling catheters.

Silicone or latex? The choice is yours.

- Foley catheters are available in 100 per cent silicone or natural rubber latex. Which type is the most appropriate depends on several factors, including whether or not your patient is allergic to particular materials as well as the length of anticipated indwell time. The pros and cons of the different materials need to be taken into consideration.

100% silicone

- Indwelling time of up to 30 days
- High biocompatibility – fewer known allergies
- Less encrustation during indwelling
- Radiopaque for easy visualisation during scans
- Smooth material for maximum comfort



Natural rubber latex (siliconised)

- Indwelling time of up to 14 days
- Many patients face latex allergies
- Faster encrustation compared to 100% silicone catheters
- Lower unit cost than silicone catheters
- Not radiopaque
- Smooth material for maximum comfort



UROSID® Silicone Foley Catheters

The UROSID® Silicone Foley Catheter is a double- or triple-lumen, transurethral urinary catheter made of 100 per cent medical-grade silicone. Each comes with either a straight, atraumatic Nelaton tip or a slightly curved, atraumatic Tiemann tip, and features a continuous barium sulphate X-ray contrast strip for radiopacity. Foley catheters with a Nelaton tip can be used for both female and male catheterisation, while catheters with a Tiemann tip are primarily used for catheterising male patients with a narrowed, scarred or difficult-to-pass urethra.

These catheters are suitable for both passive emptying and retrograde filling/drainage of the bladder. Each is colour-coded and can be used in conjunction with extensions, as well as all Medline urine bags. In addition, the valve of the filling channel has a luer syringe attachment. The catheter balloons have different filling volumes between 5 and 30 ml.

UROSID® Basic Silicone Foley Catheter Type: Nelaton, double lumen

REF 6421xxA



Reference	Size (CH)	Length (cm)	Balloon volume (ml)	Colour	Units (ea)
642112A	12	40	5 – 15	White	10
642114A	14	40	5 – 15	Green	10
642116A	16	40	5 – 15	Orange	10
642118A	18	40	5 – 15	Red	10
642120A	20	40	5 – 15	Yellow	10
642122A	22	40	5 – 15	Purple	10
642124A	24	40	5 – 15	Blue	10

REF 6430xxA



Reference	Size (CH)	Length (cm)	Balloon volume (ml)	Colour	Units (ea)
643016A	16	40	30	Orange	10
643018A	18	40	30	Red	10
643020A	20	40	30	Yellow	10
643022A	22	40	30	Purple	10
643024A	24	40	30	Blue	10

REF 6520xx

The UROSID® Silicone Foley Catheter comes with an integrated balloon, offering more comfort for your patients.



Reference	Size (CH)	Length (cm)	Balloon volume (ml)	Colour	Units (ea)
652012	12	40	5-10	White	10
652014	14	40	5-10	Green	10
652016	16	40	5-10	Orange	10
652018	18	40	5-10	Red	10
652020	20	40	5-10	Yellow	10
652022	22	40	5-10	Purple	10
652024	24	40	5-10	Blue	10

REF 6420xxA-P

This product includes a prefilled Glyco-SID® syringe with a 10-ml water-glycerine solution (10%) as a blocker medium for filling the balloon.

Graduation of the syringe: 0.2 ml



Reference	Size (CH)	Length (cm)	Balloon volume (ml)	Colour	Units (ea)
642012A-P	12	40	10	White	5
642014A-P	14	40	10	Green	5
642016A-P	16	40	10	Orange	5
642018A-P	18	40	10	Red	5
642020A-P	20	40	10	Yellow	5
642022A-P	22	40	10	Purple	5
642024A-P	24	40	10	Blue	5

UROSID® Basic Silicone Foley Catheter
Type: Nelaton, triple lumen
REF 6440xxA

The three-way Foley catheter has an additional irrigation/injection channel for administering drug solutions or flushing the bladder.



Reference	Size (CH)	Length (cm)	Balloon volume (ml)	Colour	Units (ea)
644016A	16	40	30	Orange	10
644018A	18	40	30	Red	10
644020A	20	40	30	Yellow	10
644022A	22	40	30	Purple	10
644024A	24	40	30	Blue	10

UROSID® Basic Silicone Foley Catheter
Type: Tiemann, double lumen
REF 6530xxA

The UROSID® Silicone Foley Catheter is created especially for male patients.



Reference	Size (CH)	Length (cm)	Balloon volume (ml)	Colour	Units (ea)
653012A	12	40	10	White	10
653014A	14	40	10	Green	10
653016A	16	40	10	Orange	10
653018A	18	40	10	Red	10
653020A	20	40	10	Yellow	10

UROSID® Dufour Tip

The UROSID® Silicone Foley Catheter is a triple lumen and made of 100% silicone. It is designed with a Dufour tip, especially suited for male patients requiring continuous bladder irrigation or management of hematuria.

Available as three-way Foley catheter with Dufour Tip has an additional irrigation/injection channel for administering drug solutions or flushing the bladder.

Dufour Tip

- The curved tip allows easy introduction without stylet

Convenient

- X-ray visible line along the shaft and x-ray visible tip
- Indwelling time of up to 30 days

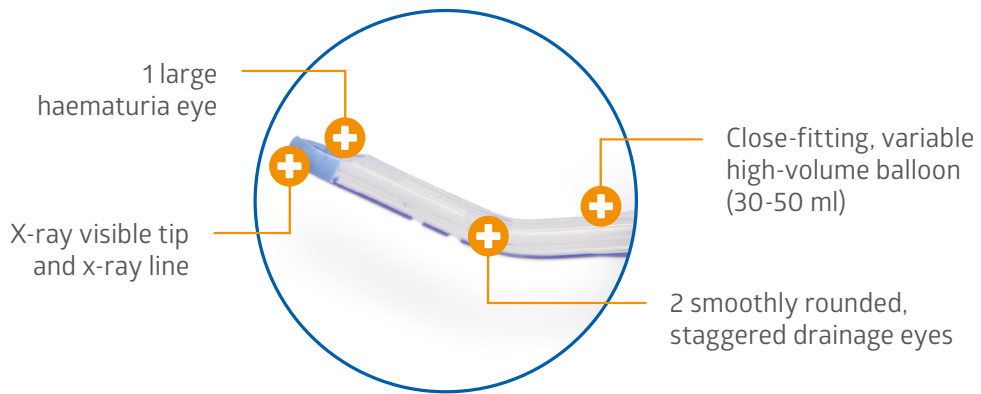

REF 6580xx

Reference	Size (CH)	Length (cm)	Balloon volume (ml)	Colour	Units (ea)
658016	16	40	30	Orange	10
658018	18	40	30	Red	10
658020	20	40	30 – 50	Yellow	10
658022	22	40	30 – 50	Purple	10
658024	24	40	50	Blue	10

UROSID® Sensor 400

The UROSID® Sensor 400 is a transurethral silicone Foley catheter with an integrated temperature sensor.

Accurate

- Continuous measurements between 25 and 45° C with an accuracy of $\pm 0.1^\circ$ C

Convenient

- Saves on nursing time for monitoring temperature where Foley catheterisation is already indicated

Compatible

- Applicable for use within most hypothermia units and with patient monitors from GE®, HP® Philips™, Siemens® and others
- We will provide you with the appropriate adapter cables
- UROSID® Sensor 400 is MRI-conditional

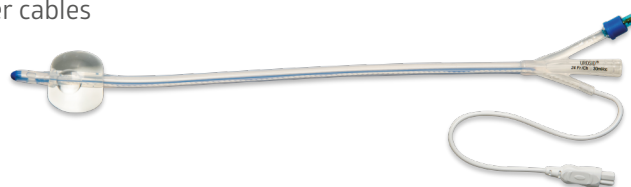

REF 6460xxA

Reference	Size (CH)	Length (cm)	Balloon volume (ml)	Colour	Units (ea)
646008A	8	31	5	Blue	5
646010A	10	31	5	Black	5
646012A	12	40	10	White	5
646014A	14	40	10	Green	5
646016A	16	40	10	Orange	5
646018A	18	40	10	Red	5
646020A	20	40	30	Yellow	5
646022A	22	40	30	Purple	5
646024A	24	40	30	Blue	5

Adapter cables

Adapter cables are used to connect the UROSID® Sensor 400 with patient monitors. The appropriate adapter cable is chosen based on the kind of patient monitor in use.

References	Name	Length (cm)	Units (ea)	Compatible Brand
646060A	Phone plug, straight, 6.35 mm	500	1	YSI 400 Compatible Dräger, GE (Selected Models)
646070A	Round connector, straight	500	1	YSI 400 Compatible HP, Philips
646080A	Round connector, straight	500	1	YSI 400 Compatible Siemens



All UROSID® Basic Silicone Foley Catheters are:

- Free from natural rubber latex
- DEHP- and PHT-free
- Sterile (EO).

UROSID® Latex Foley Catheters

The UROSID® Latex Foley Catheter is a double- or triple-lumen, transurethral urinary catheter made of siliconised natural rubber latex. Each comes with either a straight, atraumatic Nelaton tip or a slightly curved, atraumatic Tiemann tip. Foley catheters with a Nelaton tip can be used for both female and male catheterisation, while catheters with a Tiemann tip are primarily used for catheterising male patients with a narrowed, scarred or difficult-to-pass urethra.

These catheters are suitable for both passive emptying and retrograde filling/drainage of the bladder. Each is colour-coded and can be used with commercially available extensions, as well as all Medline urine bags. In addition, the valve of the filling channel has a luer syringe attachment. The catheter balloons have different filling volumes between 5 and 30 ml.

UROSID® Latex Foley Catheter

Type: Nelaton, double lumen



REF 6620xxA

Reference	Size (CH)	Length (cm)	Balloon volume (ml)	Valve	Colour	Units (ea)
662012A	12	40	5 – 10	PVC	White	10
662014A	14	40	5 – 10	PVC	Green	10
662016A	16	40	5 – 10	PVC	Orange	10
662018A	18	40	5 – 10	PVC	Red	10
662020A	20	40	5 – 10	PVC	Yellow	10
662022A	22	40	5 – 10	PVC	Purple	10
662024A	24	40	5 – 10	PVC	Blue	10
662026A	26	40	5 – 10	PVC	Black	10



REF 6622xxA

Reference	Size (CH)	Length (cm)	Balloon volume (ml)	Valve	Colour	Units (ea)
662212A	12	40	5 – 10	Rubber	White	10
662214A	14	40	5 – 10	Rubber	Green	10
662216A	16	40	5 – 10	Rubber	Orange	10
662218A	18	40	5 – 10	Rubber	Red	10
662220A	20	40	5 – 10	Rubber	Yellow	10
662222A	22	40	5 – 10	Rubber	Purple	10
662224A	24	40	5 – 10	Rubber	Blue	10
662226A	26	40	5 – 10	Rubber	Black	10



The rubber valve is MRI-conditional.

UROSID® Latex Foley Catheter Type: Nelaton, double lumen

REF 6630xxA



Reference	Size (CH)	Length (cm)	Balloon volume (ml)	Colour	Units (ea)
663012A	12	40	30	White	10
663014A	14	40	30	Green	10
663016A	16	40	30	Orange	10
663018A	18	40	30	Red	10
663020A	20	40	30	Yellow	10
663022A	22	40	30	Purple	10
663024A	24	40	30	Blue	10
663026A	26	40	30	Black	10

UROSID® Latex Foley Catheter Type: Tiemann, double lumen

REF 6650xxA

The UROSID® Latex Foley Catheter with a Tiemann tip is created especially for male patients.



Reference	Size (CH)	Length (cm)	Balloon volume (ml)	Colour	Units (ea)
665012A	12	40	5 – 10	White	10
665014A	14	40	5 – 10	Green	10
665016A	16	40	5 – 10	Orange	10
665018A	18	40	5 – 10	Red	10
665020A	20	40	5 – 10	Yellow	10

REF 6660xxA

The UROSID® Latex Foley Catheter with a Tiemann tip is created especially for male patients.



Reference	Size (CH)	Length (cm)	Balloon volume (ml)	Colour	Units (ea)
666012A	12	40	30	White	10
666014A	14	40	30	Green	10
666016A	16	40	30	Orange	10
666018A	18	40	30	Red	10
666020A	20	40	30	Yellow	10



All UROSID® Latex Foley Catheters are:
· Sterile (EO).

UROSID® Latex Foley Catheter

Type: Nelaton, triple lumen

REF 6680xxA

The three-way Foley catheter has an additional irrigation/injection channel for administering drug solutions or flushing the bladder.



Reference	Size (CH)	Length (cm)	Balloon volume (ml)	Colour	Units (ea)
668016A	16	40	30	Orange	10
668018A	18	40	30	Red	10
668020A	20	40	30	Yellow	10
668022A	22	40	30	Purple	10
668024A	24	40	30	Blue	10
668026A	26	40	30	Black	10

UROSID® Supra

Some patients cannot be catheterised through the urethra due to complications such as urethral stricture. In such cases, percutaneous bladder drainage is necessary.

The UROSID® Supra Silicone Catheter provides a solution suitable for extra-anatomical emptying of the bladder and can be used with commercially available extensions and all Medline urine bags. Each is a double-lumen, suprapubic bladder catheter made of medical-grade silicone, with an open tip and a continuous barium sulphate X-ray radiopaque line. In addition, the valve of the filling channel has a luer syringe attachment and is colour-coded. There are also small catheter sizes (6 – 10 CH) available with a guidewire (stylet) for easier insertion.



REF 6450xxA

Reference	Size (CH)	Length (cm)	Balloon volume (ml)	Colour	Units (ea)
645006A	6	40	1.5	Light Green	10
645008A	8	40	3	Blue	10
645010A	10	40	3 – 5	Black	10
645012A	12	40	5 – 10	White	10
645014A	14	40	5 – 10	Green	10
645016A	16	40	5 – 10	Orange	10
645018A	18	40	5 – 10	Red	10
645020A	20	40	5 – 10	Yellow	10
645022A	22	40	5 – 10	Purple	10
645024A	24	40	5 – 10	Blue	10
645026A	26	40	5 – 10	Black	10



All UROSID® Supra Catheters are:

- Free from natural rubber latex
- DEHP- and PHT-free
- Sterile (EO).

Accessories for UROSID® Foley Catheters

Blocker medium

Aqua-SID® and Glyco-SID®

Prefilled syringes facilitate the inflation of the balloons for UROSID® Foley Catheters (silicone or latex) during catheterisation.

Reference	Name	Feature	Units (ea)
623001	Aqua-SID®	10-ml of purified water	10
623002	Glyco-SID®	10-ml mixture of purified water and 10% glycerine	10



Spigot

REF 647010-x

A spigot is a plug that is used to close the drainage funnel of Foley catheters for a short time (e.g. during a closed system change or an examination of the patient).

Reference	Sterility	Units (ea)
647010-ST	Sterile (EO)	50
647010-NS	Non-sterile	100



Foley Anchor

REF FCS200ZT

Catheter Securement device to fixate your Foley catheter at the patients leg, making sure it will not dislocate.

Reference	Sterility	Units (ea)
FCS200ZT	Sterile (EO)	50



We provide you
with everything
you need to
catheterise
your patients.

Intermittent catheters

Intermittent catheterisation is considered a safe and effective method for urine drainage, offering personal independence and implementation in patients' everyday lives. These catheters can also be used for one-time urine sample collection directly from the bladder, offering a pure specimen result.

Medline offers intermittent catheters with either a Nelaton or Tiemann tip to ensure you have the appropriate solution for both female and male patients.

Intermittent catheter

Type: Nelaton

REF 680xxx*

These disposable catheters are made of PVC, have a rounded tip and are distally closed. Each has two Murphy eyelets positioned opposite each other. Due to their shorter length, they are especially suitable for use on women.

Reference	Size (CH)	Length (cm)	Colour	Units (ea)
680208	8	40	Blue	100
680210	10	40	Black	100
680212	12	40	White	100
680214	14	40	Green	100
680216	16	40	Orange	100
680218	18	40	Red	100
680310	10	18	Black	100
680312	12	18	White	100
680314	14	18	Green	100
680316	16	18	Orange	100

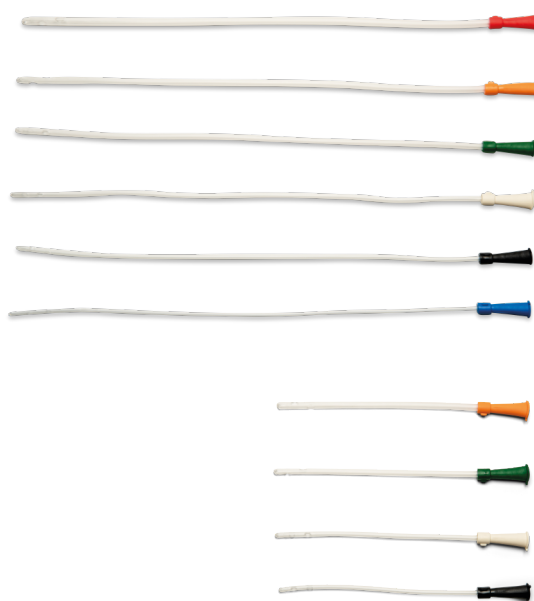

Intermittent catheter

Type: Tiemann

REF 6702xx*

These disposable catheters are made of PVC, have a curved tip and are distally closed. Each has two Murphy eyelets positioned opposite each other. Tiemann tip catheters are especially suitable for use on male patients.

Reference	Size (CH)	Length (cm)	Colour	Units (ea)
670212	12	40	White	100
670214	14	40	Green	100
670216	16	40	Orange	100
670218	18	40	Red	100



- Smooth tip for easy insertion and comfort
- Staggered eyes allow for maximum flow
- Funnel end for ease of handling
- Colour-coded to indicate Charrière size
- All sizes are packaged sterile (EO)
- Made in Germany



*Not available in AT, CH, HU, IT and UK

Urine drainage systems



Closed system

With closed urine drainage systems, the flow of urine is interrupted via a drip chamber between the tube and the urine bag. As a result, the urinary catheter, along with the tube, forms a separate second system aside from the urine bag. The use of a closed urine drainage system is recommended for multi-day urine drainage and can effectively reduce the risk of CAUTI in comparison to basic urine bags.

The Robert Koch Institute (RKI) recommends maintaining a sterile, continuously closed urinary diversion system for preventing and controlling CAUTIs. The RKI has even said it is possible that 70 per cent of all CAUTIs can be prevented by applying certain measures:¹

- Reduce unnecessary catheterisation
- Keep the indwelling time to a minimum
- Train personnel
- Implement hand hygiene and the aseptic technique
- Implement daily surveillance
- Use a closed urine drainage system.

From basic to professional

Medline offers a wide range of urine collection bags to meet all your needs. From a basic secretion bag without a stopcock to urine meters for precise urine flow measurement, we have you covered.



Closed urine drainage system

The design of the UROSID® 2000 S Urine Drainage System can help prevent or reduce the risk of CAUTIs. It is difficult to maintain a closed system if the indwelling time of the Foley catheter is different from that of the drainage system. When disconnecting the drainage system from the catheter, the risk of CAUTI increases. The Medline urine drainage system has specific features that help keep the patient safe during the changing process.

Drip chamber with integrated non-return valve

Separates the tube and the bag into 2 individual systems, which prevents urine from flowing back into the tubing from the bag

Microfilter

Bag ventilation for pressure balance; impervious to bacteria and liquids



Cross valve

Drainage valve to empty the bag while maintaining the closed system

Needle-free urine sampling port

For safe urine sampling collection using a luer syringe without a needle

UROSID® 2000 S



- Drip chamber with integrated non-return valve
- Cross valve
- Hydrophobic coated microfilter
- Bacteria and liquid-tight bag ventilation
- Needle-free urine sample collection port or collection with needle
- Sterile (EO)
- Free from natural rubber latex



Reference	Volume (ml)	Tubing length (cm)	Cross valve	Urine sampling port	Units (ea)
690090-N	2000	90	Horizontal	Needle-free	25
690092-N	2000	90	Vertical	Needle-free	25
690210-N	2000	120	Horizontal	Needle-free	25
690212-N	2000	120	Vertical	Needle-free	25
690090	2000	90	Horizontal	With needle	25
690092	2000	90	Vertical	With needle	25
690210	2000	120	Horizontal	With needle	25
690212	2000	120	Vertical	With needle	25

Horizontal cross valve



Vertical cross valve



Needle-free sampling port



Sampling port with needle



UROSID® TUR-bag

After a transurethral resection of the prostate (TURP), the special UROSID® TUR-bag is indicated for post-operative bladder irrigation. This procedure indicates continuous flushing of the bladder for the first 24 hours. However, due to the high amount of rinsing solution and urine, the UROSID® TUR-bag is larger than other closed drainage systems. It comes with either a 4-litre or 5-litre bag.



- Drip chamber with integrated non-return valve
- Cross valve
- Hydrophobic coated microfilter
- Bacteria and liquid-tight bag ventilation
- Needle-free urine sample collection port or collection with needle
- Sterile (EO)
- Free from natural rubber latex

Reference	Name	Volume (ml)	Tubing length (cm)	Urine sampling port	Units (ea)
690240	UROSID® TUR-bag 4000	4,000	120	Needle-free	20
690250	UROSID® TUR-bag 5000	5,000	120	With needle	20

REF 6440xxA UROSID® Silicone Foley Catheter (page 10)



REF 6680xxA UROSID® Latex Foley Catheter (page 14)



Note:

For attaching the rinsing solution and the UROSID® TUR-bag, you always need to use a triple-lumen Foley catheter.

Urine meters

Urine production constitutes an essential part of fluid balance/elimination. In intensive care medicine, it is important to monitor vital parameters (e.g. respiration, circulation and elimination) over a 24-hour period, in order to prevent organ failure (e.g. in the kidneys or gall bladder). The UROSID® Urine Measurement System is equipped with additional graduated chambers to facilitate accurate monitoring and urine sampling, even in cases when there is very little urine.

Our range has two different versions of urine meters: tilting systems and exchange bags systems.

Why do you need it?

To manage the fluid control of your patient (e.g. after surgery)

When do you use it?

During the application of intensive care medicine

Tilting systems

The UROSID® Urine Measurement System is available in three different variations to meet your specific needs. Medline's urine meters are available with single-, double- or triple-chamber variations. However, all systems offer accurate measurements, starting with a 5-ml graduation.

Single-chamber urine meter

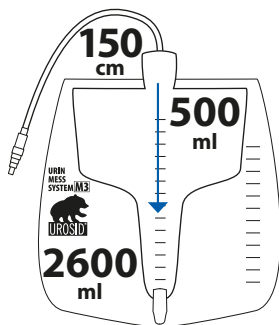

Double-chamber urine meter

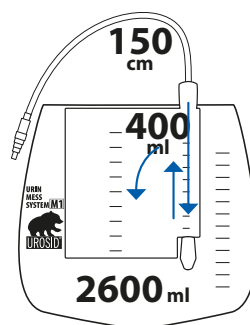

Triple-chamber urine meter

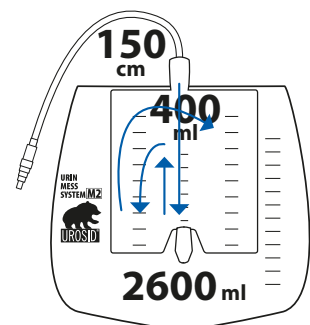

How does it work?

After measuring the urine collected in the chamber, tilt the chamber upwards to empty the contents into the attached urine bag



- Drip chamber with integrated non-return valve
- Cross valve
- Hydrophobic coated microfilter
- Bacteria and liquid-tight bag ventilation
- Needle-free urine sample collection point or collection with needle
- Sterile (EO)
- Free from natural rubber latex

UROSID® M3 Single-Chamber Urine Meter

REF 6903x3-x

Reference	Bag volume (ml)	Urine meter volume (ml)	Tubing length (cm)	Feature	Units (ea)
690313	2,600	500	150	With needle	10
690313-L	2,600	500	150	With needle; extended drip chamber	10
690313-N	2,600	500	150	Needle-free	10
690313-N-IP	2,600	500	150	Needle-free, without cotton string	10
690323	2,600	500	120	With needle	10



UROSID® M1 Double-Chamber Urine Meter

REF 6903x1

Reference	Bag volume (ml)	Urine meter volume (ml)	Tubing length (cm)	Feature	Units (ea)
690311	2,600	400	150	With needle	10
690321	2,600	400	120	With needle	10



UROSID® M2 Triple-Chamber Urine Meter

REF 6903x2

Reference	Bag volume (ml)	Urine meter volume (ml)	Tubing length (cm)	Feature	Units (ea)
690312	2,600	400	150	With needle	10
690322	2,600	400	120	With needle	10



Exchange Bag Systems

The UROSID® Urine Measurement System with Exchange Bag is available in two different versions to meet your specific needs. Medline offers a variant of the urine meters with a drainage valve, which gives clinicians the option to empty the exchange bag through the valve. For the alternative variant without a drainage valve, it is necessary to replace the bag once it is filled to capacity.

How does it work?

After measuring the urine collected in the chamber, open the tap on the top of the chamber. This will allow the urine to drain into the exchange bag positioned below.

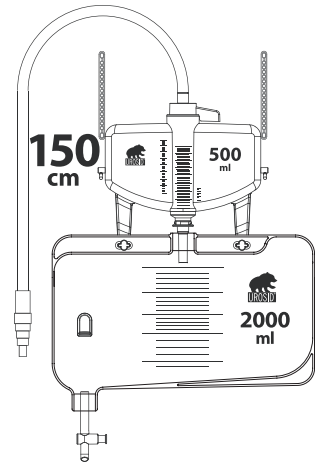

UROSID® M5 Urine Meter with Exchange Bag

REF 69050x-N

Reference	Bag volume (ml)	Urine meter volume (ml)	Tubing length (cm)	Feature	Units (ea)
690500-N	2,000	500	150	With cross valve	10
690500-N-IP	2,000	500	150	With cross valve, without cotton string	10
690501-N	2,000	500	150	Without drainage valve	10



Exchange Bag for UROSID® M5 Urine Meter

REF 69050x-BAG

Reference	Bag volume (ml)	Feature	Units (ea)
690500-BAG	2,000	With cross valve	50
690501-BAG	2,000	Without drainage valve	50



IAP Manometer

The UROSID® Intra-Abdominal Pressure (IAP) Manometer plays a crucial role in preventing abdominal compartment syndrome (ACS). It is an easy-to-use device that is designed to facilitate the monitoring of intra-abdominal pressure (IAP), and it provides a secure connection between the Foley catheter and the UROSID Urine Meter of your choice.

Intra-abdominal hypertension (IAH) is characterised by sustained intra-abdominal pressure (IAP) exceeding 12 mmHg. ACS occurs when the pressure within the abdominal cavity surpasses 20 mmHg. This condition is linked to multi-organ dysfunction, posing a severe threat to patients in the intensive care unit (ICU).²

To mitigate the risk of ACS, it is essential to measure IAP when the risk of IAH is identified.² The UROSID IAP Manometer is designed to provide indirect, minimally invasive measurements of intra-abdominal pressure, using a Foley catheter.

Reference	Scale (mmHg)	Units (ea)
690000-IAP	0 - 40	20



Urine bags

Urinary bags facilitate the collection of the urine drained from urinary catheters in patients with urinary retention or involuntary urination, as well as those who are bedridden, paralysed or have a disability. The non-return valve (NRV) reduces the number of infections that reach the bladder via the Foley catheter. And unlike a closed urine drainage system, urine bags do not contain a drip chamber.

UROSID® 20

The UROSID® 20 offers a sterile urine bag system.



The urine bag system's features:

- Non-return valve (NRV)
- Cross valve
- Hydrophobic coated microfilter
- Urine sample extraction point on the universal step connector
- Hose and bed sheet clamp
- Available with or without holder
- Free from natural rubber latex
- Sterile (EO)



Reference	Volume (ml)	Tubing length (cm)	Feature	Units (ea)
690190	2,000	90	Without holder	50
690120	2,000	120	Without holder	50
690120-H	2,000	120	With holder	50

Urine bag



The urine bag's features:

- Non-return valve (NRV)
- Cross valve
- Universal step connector
- Free from natural rubber latex



Reference	Volume (ml)	Tubing length (cm)	Urine Sampling port	Sterility	Units (ea)
690220	2,000	90	n/a	Sterile (EO)	50
690230	2,000	90	n/a	Non-sterile	200
691220-N	2,000	120	Needle-free	Sterile (EO)	50

Secretion bag

This bag allows for the collection of discharged bodily fluids, such as urine from bladder catheters. It requires changing after filling, as it is not possible to empty it. In addition, the secretion bag can be attached to the UROSID® Leg Bag at night.



The secretion bag's features:

- Non-return valve (NRV)
- Universal step connector
- Free from natural rubber latex



Reference	Volume (ml)	Tubing length (cm)	Feature	Sterility	Units (ea)
690415	1,500	90	With NRV	Non-sterile	200
690420	2,000	90	With NRV	Non-sterile	200
690515	1,500	90	Without NRV	Non-sterile	200
690520	2,000	90	Without NRV	Non-sterile	200
690615	1,500	90	With NRV	Sterile (EO)	100
690620	2,000	90	With NRV	Sterile (EO)	100

Accessories

Urine bag holders (non-sterile)



REF 690010
Made from plastic

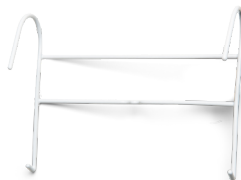

REF 690020
Made from plastic-coated metal



REF 690030
Made from plastic

Reference	Units (ea)
6900x0	10

Bed sheet clamp (non-sterile)

Helps you secure the tube of the urine bag to the bed sheet



Reference	Units (ea)
681050	50

Urine bottle and urine bottle holder

The urine bottle is ideal for bedridden male patients to collect urine. The square urine bottle is graduated and has a capacity of 1,000 ml. Each is compatible with the urine bottle holder.



REF 690050A



REF 690055A

Reference	Units (ea)
69005xA	25

UROSID® 24h

The perfect match between the closed urine drainage system and leg bag

The UROSID® 24h is a closed urinary drainage system for collecting the urine discharged from urinary catheters in patients with urinary retention or involuntary urination. UROSID® 24h is a bed/leg bag combination that enables mobile patients with urinary catheters to go about their everyday lives. This product can be attached to the bed of the patient, and can also be worn underneath clothing while attached to the upper or lower leg.



- Drip chamber
- With non-return valve (NRV)
- Hydrophobic coated microfilter
- Universal stepped connector with urine sampling point
- Cross valve
- Attachment to leg or bed via a strap
- Woven inner surface
- Sterile (EO)
- Free from natural rubber latex
- PHT- and DEHP-free



Reference	Volume (ml)	Tubing length (cm)	Units (ea)
693730	1,000	30	20
693760	1,000	60	20
693790	1,000	90	20

Strap for UROSID® 24h



Reference	Length (cm)	Units (ea)
693702	58	10

REF 6904xx, 6905xx or 6906xx secretion bag (page 24)



Note:
You can attach a secretion bag to UROSID® 24h at night.



Leg bags

UROSID® Leg Bags

Leg bags with a capacity of up to 1,000 ml enable mobile patients with urinary catheters to go about their everyday lives. They are attached to the upper or lower leg and worn underneath clothing. A triple-chamber leg bag has three separate chambers, allowing it to fit perfectly on the leg.

Single-Chamber Leg Bag

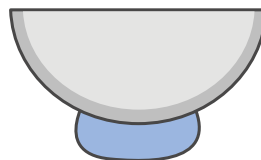

Triple-Chamber Leg Bag

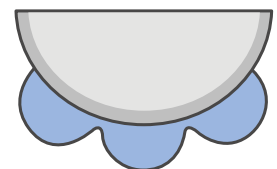

UROSID® Single-Chamber Leg Bag

The Single-Chamber Leg Bag offers a solution for collecting urine discharged from bladder catheters and features a gradual step connector, non-return valve (NRV) and central drain.



Reference	Volume (ml)	Tubing length (cm)	Sterility	Units (ea)
690710	750	10	Non-sterile	10

The Single-Chamber Leg Bag is ideal for collecting urine discharged from bladder catheters. It has features like a gradual step connector, non-return valve (NRV) and a cross valve. The inner woven surface allows for increased wearer comfort, whilst the additional step connector gives the option of shortening the tube to adjust it to specific patients requirements.



Reference	Volume (ml)	Tubing length (cm)	Sterility	Units (ea)
691770	750	50	Sterile (EO)	10

UROSID® Leg Bags

UROSID® Triple-Chamber Leg Bag

The Triple-Chamber Urine Leg Bag provides a solution for collecting urine discharged from bladder catheters. Each features a gradual step connector, non-return valve (NRV) and cross valve or flap valve. Additionally, the inner woven surface provides increased wearer comfort, and the extra gradual step connector allows for tube shortening based on the individual. An attachment piece for use as a night bag is also included.



Reference	Volume (ml)	Tubing length (cm)	Feature	Sterility	Units (ea)
690735	500	50	Cross valve	Sterile (EO)	10
690740	500	65	Cross valve	Sterile (EO)	10
690745	750	65	Cross valve	Sterile (EO)	10
690760	500	50	Flap valve	Sterile (EO)	10
691755	750	50	Cross valve	Sterile (EO)	10
691760	750	50	Flap valve	Sterile (EO)	10
692735	500	50	Cross valve	Non-sterile	10
692755	750	50	Cross valve	Non-sterile	10

Cross valve



Flap valve



Strap for UROSID® Leg Bags

This strap is ideal for attaching UROSID® Leg Bags to the leg. It is comfortable to wear, and the comfort and standard types come with a silicone strip on the inside for better gripping. The closure is fitted with Velcro.



Reference	Name	Size	Length x width (cm)	Feature	Units (ea)
856001	Comfort	S (small)	40 x 5	Packaged individually	10
856002	Comfort	M (medium)	50 x 5	Packaged individually	10
856003	Comfort	L (large)	60 x 5	Packaged individually	10
856006	Universal	Universal	63 x 2.5; 63 x 3.5	Packaged in pairs	10
856008	Standard	Universal	53 x 2.5	Packaged in pairs	10

Paediatric products



Paediatric products for our smallest patients

Urological products for children are as important to offer as those for adults. The youngest patients have specific needs that we can provide solutions for with our paediatric product range. CAUTI prevention is equally as important in children as it is in adults, and consequently, our catheter exchange kits can also be used with children. All paediatric products are sterile (EO).



- Reduce unnecessary catheterisation
- Keep the indwelling time to a minimum
- Train personnel
- Implement hand hygiene and the aseptic technique
- Implement daily surveillance
- Use a closed urine drainage system



Look for Molly the bear on our paediatric urology range!

Indwelling catheters

Paediatric sizes of indwelling catheters always come with a pre-inserted stylet for easy and safe positioning of the catheter.

UROSID® Foley Catheter

Available in silicone or siliconised latex

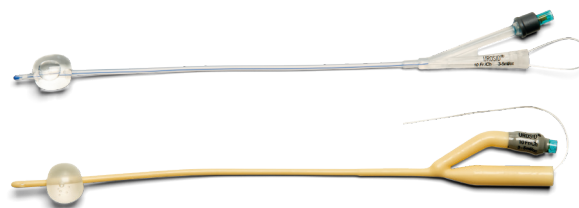

Reference	Material	Size (CH)	Length (cm)	Balloon volume (ml)	Colour	Units (ea)
641006A	Silicone	6	31	1.5	Light green	10
641008A	Silicone	8	31	3 - 5	Blue	10
641010A	Silicone	10	31	3 - 5	Black	10
661006A	Siliconised latex	6	27	3	Light green	10
661008A	Siliconised latex	8	27	3 - 5	Blue	10
661010A	Siliconised latex	10	27	3 - 5	Black	10

UROSID® Sensor 400

Reference	Size (CH)	Length (cm)	Balloon volume (ml)	Colour	Units (ea)
646008A	8	31	5	Blue	5
646010A	10	31	5	Black	5



UROSID® Supra



Reference	Size (CH)	Length (cm)	Balloon volume (ml)	Colour	Units (ea)
645006A	6	40	1.5	Light green	10
645008A	8	40	3	Blue	10
645010A	10	40	3 – 5	Black	10

Closed urine drainage systems

UROSID® 1000

This is a variant of the UROSID® 2000 S for use on paediatric patients



- Drip chamber with integrated non-return valve
- Cross valve
- Hydrophobic coated microfilter
- Bacteria and liquid-tight bag ventilation
- Needle-free urine sample collection port or collection with needle
- Sterile (EO)
- Free from natural rubber latex



Reference	Volume (ml)	Tubing length (cm)	Cross valve	Units (ea)
690270-N	1,000	90	Vertical	20

Urine meters

UROSID® M200 Single-Chamber Urine Meter

REF 690343-x

This is the paediatric version of UROSID® M3. It features a smaller bag and urine meter, perfect for use on young patients.



Reference	Volume bag (ml)	Volume urine meter (ml)	Tubing length (cm)	Feature	Units (ea)
690343	2,000	200	120	With needle	10
690343-N	2,000	200	120	Needle-free	10

Irrigation syringes



Piston irrigation syringe

This is a sterile (EO), graduated, disposable irrigation syringe with a straight catheter hub and luer adapter. It can be used with bladder catheters and stomach tubes (e.g. for bladder irrigation).



Reference	Volume (ml)	Units (ea)
620060	50 – 60	50
620100	100	25

Irrigation bulb syringe

Ideal for use in clinical and surgical settings, this disposable irrigation bulb syringe facilitates easy gripping, thereby allowing for excellent one-handed use. Designed to stand on its end, it helps prevent leakage and maintain a clean environment.



Reference	Volume (ml)	Sterility	Units (ea)
DYNDE20127	60	Non-sterile	50
DYNDE20125	60	Sterile (EO)	25

Gastro- enterological products



Rectal tubes*

These are straight intestinal catheters with two eyelets for administering enemas and draining intestinal gases.

Reference	Size (CH)	Length (cm)	Colour	Units (ea)
680418	18	40	Red	100
680422	22	40	Purple	100
680425	25	40	Blue	100
680428	28	40	Green	100
680430	30	40	Grey	100



Enema kit

Medline's enema kit provides everything required for an enema.



Each kit includes:

- 1 bag with a tube, clamp and pre-lubricated tip, 1.5 l
- 1 packet of liquid soap, 9 ml
- 1 underpad, fluid-resistant, 42 x 45 cm



Reference	Volume (ml)	Tube length (cm)	Sterility	Units (ea)
DYNDE70100A	1,500	137	Non-sterile	48

*Not available in AT, CH, HU, IT and UK

For more information, please contact your Medline representative or visit our website www.medline.eu/uk



Medline Industries Ltd.
3rd Floor
Quayside Wilderspool Business Park
Greenalls Avenue
Warrington WA4 6HL
United Kingdom
Tel.: +44 844 334 5237

www.medline.eu/uk
uk-customerservice@medline.com

Medline Ireland Ltd.
1 Grant's Row
Mount Street Lower
Dublin 2
Ireland
Tel.: +353 1 691 73 06

www.medline.eu/ie
ie-customerservice@medline.com

FOLLOW US  

Sources:

1. https://www.rki.de/DE/Content/Infekt/Krankenhaushygiene/Kommission/Downloads/CAUTI_2015.pdf?__blob=publicationFile
2. Newman, R.K. (2023) Abdominal compartment Syndrome. <https://www.ncbi.nlm.nih.gov/books/NBK430932/>.

Before use, please consult instructions and precautions on the corresponding labelling.

All rights reserved. We reserve the right to correct errors that may have occurred.

© 2026 Medline. ML1338_EN 06/2026