

# Surgical gowns, drapes & packs

Choose your protection



**Draped in  
confidence**



# Table of contents

<b>Surgical gowns</b>	<b>6</b>
<b>Surgical drapes &amp; packs</b>	<b>15</b>
<b>General surgery</b>	<b>19</b>
<u>Basic packs</u>	19
Standard universal packs	20
Reinforced universal packs	23
Abdominal and thoracic drapes & packs	30
General fenestrated packs	39
Wound ring protectors	43
<b>Supplementary drapes</b>	<b>44</b>
Universal drapes	44
Aperture drapes	49
<b>Orthopaedic</b>	<b>54</b>
Arthroscopy drapes and packs	54
Extremity drapes and packs	60
Hand drapes and packs	72
Hip drapes and packs	76
Shoulder drapes and packs	80
Split drapes and packs	85
<b>Urology / gynecology</b>	<b>97</b>
TUR drapes and packs	97
Lithotomy/cystoscopy packs	100
All in one drapes and packs	103
<b>Obstetric</b>	<b>107</b>
Delivery drapes and packs	107
C-section drapes and packs	108
<b>ENT / dental</b>	<b>113</b>
<b>Ophthalmology</b>	<b>120</b>
<b>Neurology</b>	<b>126</b>
<b>Cardiovascular</b>	<b>130</b>
Angiography drapes and packs	130
Cardiology drapes and packs	135
Pacemaker drapes and packs	138
Vascular drapes and packs	139
<b>Accessories</b>	<b>141</b>
Table covers	141
Leggings and stockinettes	143
Under-buttocks	144
Instrument pouches and swab collectors	149
Miscellaneous	151



# Why Medline surgical drapes and gowns?

Operating theatres demand best product performance at all times.

That is why Medline focusses on consistently delivering surgical drapes and gowns that are reliable and driven by performance. Listening to the feedback from our customers, we strive to develop products that meet and exceed the needs of operating theatre professionals.

## The benefits of Medline surgical drapes and gowns

- » No. 1 supplier of drapes and gowns in the world
- » Used in nearly 23 million surgical procedures across Europe
- » The broadest product line in the industry
- » Developed for clinicians and by clinicians
- » Adapted to customer needs
- » Best-in-class drape and gown fabrics
- » Adaptability of a family-run business but with the scale and structure that comes from being a major healthcare company
- » Maximises value thanks to our distribution capabilities and custom packs

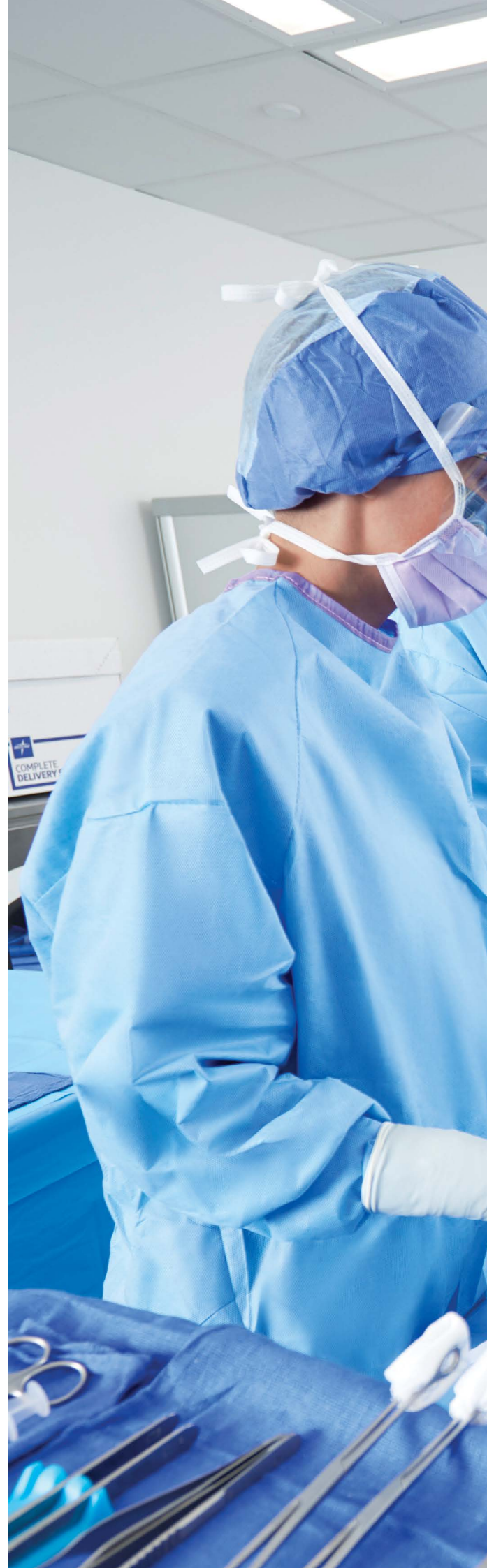









**Surgical  
gowns**

# Medline surgical gowns

Performance, quality and variety

## An extensive choice

To satisfy preferences in the operating theatre, we offer five different fabric options for surgical gowns, each with a distinct style and reinforcement.

## Dependable protection

Medline's gown fabrics offer high-level protection. Each gown is latex-free and meets or exceeds the minimum performance requirements of the EN 13795-1 standard.\* The Essential and Advanced materials have a good hydrostatic head and an extra repellent treatment gives users the protection they need. The unique Ultimate gown offers all-over impervious protection with breathability.

\*The EN 13795-1 is the European standard, specifying requirements for single-use and reusable coverings—surgical gowns and drapes used as medical devices for patients, clinical staff and equipment, intended to prevent the transmission of infective agents during invasive surgical procedures.

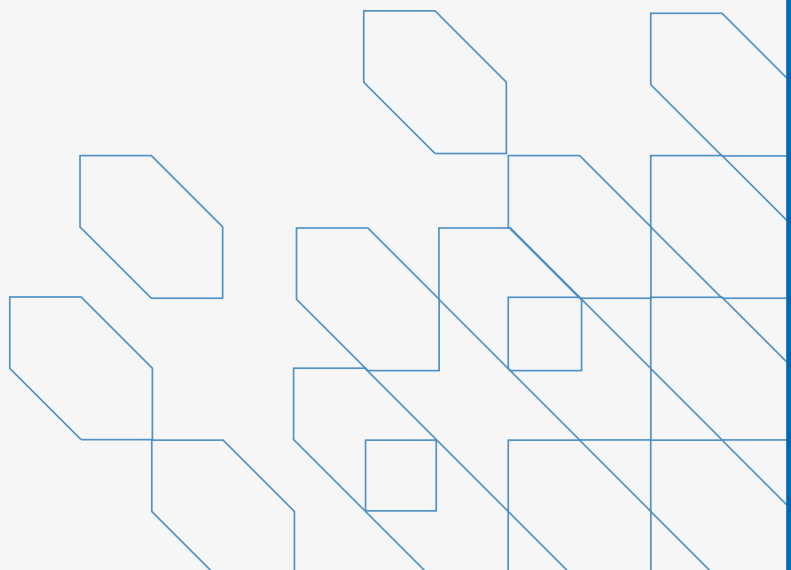



# OPS™ UltraGard

Effective gown, affordable price

- Lightweight SMS (35 gsm) material with natural fluid repellent protection
- Comfortable
- Gown available with either standard or poly-reinforced protection

Item number	Description	Qty/case
E3505CEA	Surgical gown, S/M, 115 cm	36
E3506CEA	Surgical gown, L, 120 cm	36
E3545CEA	Surgical gown, XL, 130 cm	36
FE3545CE	Surgical gown, XL, 140 cm	32
E3516CEA	Surgical gown, XL, 150 cm	32
E3585CEA	Surgical gown, 2XL, 160 cm	20
E3500CEA	Surgical gown, poly-reinforced, S/M, 115 cm	32
E3510CEA	Surgical gown, poly-reinforced, L, 120 cm	32
E3540CEA	Surgical gown, poly-reinforced, XL, 140 cm	28
E3513CE	Surgical gown, poly-reinforced, XL, 150 cm	24
E3581CE	Surgical gown, poly-reinforced, 2XL, 160 cm	20



# OPS™ Essential

## Enhanced protection

- Lightweight SMS (35 gsm) material with extra treatment for enhanced repellency
- Comfortable; offers exceptional drapeability
- Available with standard, fabric-reinforced or poly-reinforced protection

Item number	Description	Qty/case
S3505CEC	Surgical gown, S/M, 115 cm	36
S3506CEC	Surgical gown, L, 120 cm	36
S3545CEC	Surgical gown, XL, 130 cm	36
FS3545CEA	Surgical gown, XL, 140 cm	32
S3516CEC	Surgical gown, XL, 150 cm	32
S3585CEC	Surgical gown, 2XL, 170 cm	32
S3504CEC	Surgical gown, fabric-reinforced, S/M, 115 cm	32
S3508CEC	Surgical gown, fabric-reinforced, L, 120 cm	28
S3509CEC	Surgical gown, fabric-reinforced, XL, 130 cm	28
S3512CEC	Surgical gown, fabric-reinforced, XL, 150 cm	28
S3511CEC	Surgical gown, fabric-reinforced, 2XL, 170 cm	24
S3500CEC	Surgical gown, poly-reinforced, S/M, 115 cm	32
S3510CEC	Surgical gown, poly-reinforced, L, 120 cm	32
S3540CEC	Surgical gown, poly-reinforced, XL, 140 cm	28
S3513CEB	Surgical gown, poly-reinforced, XL, 150 cm	24
S3581CEB	Surgical gown, poly-reinforced, 2XL, 170 cm	20
S3591CE	Surgical gown, poly-reinforced, 3XL, 140 cm	24
S3587CE	Surgical gown, poly-reinforced, 3XL, 170 cm	20



OPS™ Essential gowns are also available with finger loops and/or masks.

Item number	Description	Qty/case
S3507CEC	Surgical gown, XL, 140 cm, finger loops	32
S3740CE	Surgical gown, poly-reinforced, XL, 140 cm, finger loops	28
S3713CE	Surgical gown, poly-reinforced, XL, 150 cm, finger loops	24
S3840CE	Surgical gown, poly-reinforced, XL, 140 cm, mask and finger loops	28
S3813CE	Surgical gown, poly-reinforced, XL, 150 cm, mask and finger loops	24
S3881CE	Surgical gown, poly-reinforced, 2XL, 170 cm, mask and finger loops	20

# OPS™ Advanced

No compromise between comfort and protection

- Higher basis weight, SMS (41 gsm) for enhanced protection
- With additional soft finish for optimal comfort
- Available with standard, fabric-reinforced or poly-reinforced protection
- Optional raglan cut increases roominess and provides easier movement

Item number	Description	Qty/case
OP9505CE	Surgical gown, S/M, 120 cm	28
OP9506CEA	Surgical gown, L, 130 cm	32
OP9507CEA	Surgical gown, XL, 140 cm	32
OP9516CEB	Surgical gown, XL, 150 cm	32
OP39516CE	Surgical gown, XL, 150 cm, raglan sleeves	24
OP9575CE	Surgical gown, 2XL, 150 cm	24
OP9585CE	Surgical gown, 2XL, 170 cm	20
OP9590CE	Surgical gown, 3XL, 135 cm	24
OP9508CEA	Surgical gown, fabric-reinforced, L, 130 cm	24
OP9509CEA	Surgical gown, fabric-reinforced, XL, 140 cm	28
OP9512CE	Surgical gown, fabric-reinforced, XL, 150 cm	24
OP39512CE	Surgical gown, fabric-reinforced, XL, 150 cm, raglan sleeves	20
OP9583CE	Surgical gown, fabric-reinforced, 2XL, 170 cm	20
OP9500CE	Surgical gown, poly-reinforced, S/M, 120 cm	28
OP9510CE	Surgical gown, poly-reinforced, L, 130 cm	28
OP9540CE	Surgical gown, poly-reinforced, XL, 140 cm	24
OP9513CE	Surgical gown, poly-reinforced, XL, 150 cm	20
OP9581CE	Surgical gown, poly-reinforced, 2XL, 170 cm	20



OPS™ Advanced gowns are also available with finger loops and masks.

Item number	Description	Qty/case
OP9809CE	Surgical gown, fabric-reinforced, XL, 130 cm, mask and finger loops	28
OP9812CE	Surgical gown, fabric-reinforced, XL, 150 cm, mask and finger loops	24



# Eclipse

## A soft and comfortable gown

- Optimal comfort
- High tear-resistance
- Spunlace material with a textile-like appearance and feel
- Available with standard, fabric-reinforced or poly-reinforced protection

Item number	Description	Qty/case
9505CEA	Surgical gown, S/M, 115 cm	28
9506CEA/9506DCE*	Surgical gown, L, 120 cm	28/40*
9415CEA	Surgical gown, L, 120 cm, raglan sleeves	26
9507CEA/9507DCE*	Surgical gown, XL, 130 cm	24/40*
9516CEA/9516DCE*	Surgical gown, XL, 150 cm	24/36*
9575CEA	Surgical gown, 2XL, 130 cm	24
9585CE/9585DCE*	Surgical gown, 2XL, 170 cm	24/32*
9508CEA	Surgical gown, fabric-reinforced, L, 120 cm	24
9509CEA/9509DCE*	Surgical gown, fabric-reinforced, XL, 130 cm	22/32*
9539CEA	Surgical gown, fabric-reinforced, XL, 130 cm	7
9571CEA	Surgical gown, fabric-reinforced, 2XL, 130 cm	20
9512CEA	Surgical gown, fabric-reinforced, XL, 150 cm	22
9451CEA	Surgical gown, fabric-reinforced, XL, 150 cm	11
9581CEA/9581DCE*	Surgical gown, fabric-reinforced, 2XL, 170 cm	19/28*
9000CEA	Surgical gown, poly-reinforced, S/M, 115 cm	28
9010CEA	Surgical gown, poly-reinforced, L, 120 cm	28
9040CEA	Surgical gown, poly-reinforced, XL, 130 cm	24
9513CEA	Surgical gown, poly-reinforced, XL, 150 cm	24
9580CE/9580DCE*	Surgical gown, poly-reinforced, 2XL, 170 cm	20/28*



\*This item is also available in dispenser boxes.

## Eclipse gowns are also available with finger loops and/or masks.

Item number	Description	Qty/case
9707CE	Surgical gown, XL, 130 cm, finger loops	24
9716CE	Surgical gown, XL, 150 cm, finger loops	24
9709CE	Surgical gown, fabric-reinforced, XL, 130 cm, finger loops	22
9712CE	Surgical gown, fabric-reinforced, XL, 150 cm, finger loops	22
9809CE	Surgical gown, fabric-reinforced, XL, 130 cm, mask and finger loops	22
9812CEA	Surgical gown, fabric-reinforced, XL, 150 cm, mask and finger loops	20

# OPS™ Ultimate

The intelligent gown with breathable membrane technology

- High Performance (HP) throughout the entire gown
- Made of 60-gsm trilaminate material
- Breathable, microporous fabric
- Recommended for procedures where impervious protection throughout is needed, such as long cardiological, orthopaedic and transplant surgeries

Item number	Description	Qty/case
UL89045CE	Surgical gown, breathable, impervious, XL, 130 cm	20
UL32474CE	Surgical gown, breathable, impervious, XL, 150 cm, raglan sleeves	20
UL39079CE	Surgical gown, breathable, impervious, 2XL, 150 cm, raglan sleeves	20



## Urology gowns

Optimised coverage ideal for fluid-heavy, seated urology procedures

Item number	Description	Qty/case
DYNJPE2304	Surgical gown, impervious, size, with pleat, L, 114 cm	30
DYNJPE2305	Surgical gown, impervious, size, with pleat, XL, 142 cm	30



# Dual protection



## Advanced viral and chemical protection

Enhanced clinician protection for your peace of mind is available. We offer two ranges of surgical gowns with extensive testing against chemicals and infectious agents. These solutions are classified as Medical Device class I (MDD) and Personal Protective Equipment category III (PPE) EN14605 and EN14126.

### OPS™ Essential

Essential dual-certified gowns offer MDD/PPE Category III [PB]-4 protection against chemicals and infectious agents on the reinforced area. A full list of testing results is available in the related instructions for use and technical data sheets.

Item number	Description	Qty/case
S3500P	Surgical gown, poly-reinforced, S/M, 115 cm	32
S3510P	Surgical gown, poly-reinforced, L, 120 cm	32
S3540P	Surgical gown, poly-reinforced, XL, 140 cm	28
S3513P	Surgical gown, poly-reinforced, XL, 150 cm	24
S3581P	Surgical gown, poly-reinforced, 2XL, 170 cm	20



### Prevention™ Plus

As the end user, you have enhanced protection against fluids and 14 tested cytotoxic drugs (chemotherapy) throughout the entire gown. This is facilitated by an innovative design with a microporous breathable and impervious four-layer material—ideal for protecting clinicians when performing hyperthermic intraperitoneal chemotherapy (HIPEC) treatments.

Item number	Description	Qty/case
DYNJPE2301P	Surgical gown, impervious, L, 114 cm	24
DYNJPE2302P	Surgical gown, impervious, XL, 142 cm	24





# Direct packaging solution

Medline offers an efficient, economic and environmentally-friendly solution to your facility's operating theatre needs. In addition to simplifying staff operations and eliminating non-essential overwrap and hand towels, the direct packaging gown solution helps reduce your facility's waste and lower the affiliated costs.

The direct packaging solution helps minimise packaging and raw material usage, which can increase supply chain efficiency, improve waste management, and most importantly, limit negative environmental impacts. Our approach is informed by insights from our product life cycle assessment (LCA).

## OPS™ Ultragard direct gowns are available in standard and poly-reinforced ranges.

Item number	Description	Qty/case
E3605CE	Surgical gown, S/M, 115 cm, direct	40
E3606CE	Surgical gown, L, 120 cm, direct	40
E3645CE	Surgical gown, XL, 130 cm, direct	40
E3616CE	Surgical gown, XL, 150 cm, direct	36
E3600CE	Surgical gown, poly-reinforced, S/M, 115 cm, direct	36
E3610CE	Surgical gown, poly-reinforced, L, 120 cm, direct	36
E3640CE	Surgical gown, poly-reinforced, XL, 140 cm, direct	32
E3613CE	Surgical gown, poly-reinforced, XL, 150 cm, direct	28
E3681CE	Surgical gown, poly-reinforced, 2XL, 160 cm, direct	24
E3685CE	Surgical gown, 2XL, 160 cm, direct	36



## OPS™ Essential direct gowns are available in standard, fabric-reinforced, and poly-reinforced ranges.

Item number	Description	Qty/case
S3606CE	Surgical gown, L, 120 cm, direct	40
S3645CE	Surgical gown, XL, 130 cm, direct	40
S3616CE	Surgical gown, XL, 150 cm, direct	36
S3685CE	Surgical gown, 2XL, 170 cm, direct	32
S3609CE	Surgical gown, fabric-reinforced, XL, 130 cm, direct	30
FS3645CE	Surgical gown, essential, standard, XL, 140 cm, direct	36
S3612CE	Surgical gown, fabric-reinforced, XL, 150 cm, direct	28
S3611CE	Surgical gown, fabric-reinforced, 2XL, 170 cm, direct	24
S3610CE	Surgical gown, poly-reinforced, L, 120 cm, direct	32
S3640CE	Surgical gown, poly-reinforced, XL, 140 cm, direct	28
S3613CE	Surgical gown, poly-reinforced, XL, 150 cm, direct	24
S3681CE	Surgical gown, poly-reinforced, 2XL, 170 cm, direct	20





# Surgical drapes and packs



# Why medline surgical drapes?

The operating theatre demands our best performance.

That's why Medline focusses on elevating performance without compromising value. We partner with our customers to design procedure-specific drapes that meet your expectations, then take it a step further.

## Designed to excel in all the right places

- » **Generous dimensions provide a complete sterile field.**
- » **Strong hook-and-loop line holders** secure lines well and save preparation time.
- » **Hand-placed adhesive strip** provides exceptional precision and protection at the incision area.
- » **Anti-slip instrument pad** keeps instruments at hand whilst preventing them from falling to the floor.
- » **Critical-zone absorbency pad** features the highest absorbency rating and abrasion resistance where it's needed most.\*

## 1. Fluid control

Highly absorbent fabrics and fluid-impervious zones create a protective barrier and help prevent blood strikethrough and fluid contamination.





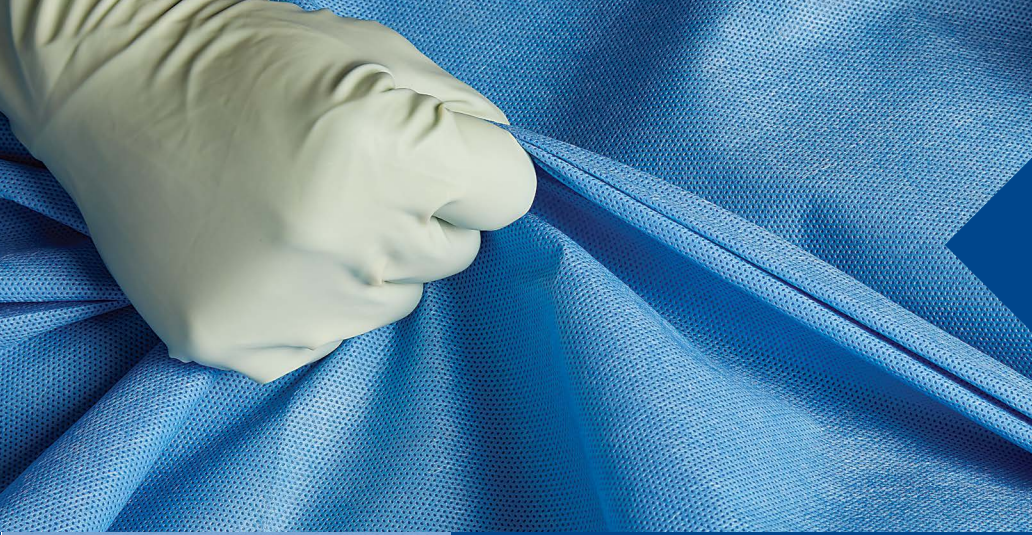

## 2. Physical strength

Heavier-weight and tear-resistant fabrics provide better protection, especially in high-movement cases like orthopaedics.



## 3. Drapeability and useability

Innovative fabric technology and design features help ensure patient safety, improve drapeability and save preparation time in the operating theatre.



## 4. Ideal fit

Skin friendly adhesive for patient's comfort.



## 5. Lint and abrasion resistance

Industry-standard lint- and abrasion-resistant drapes stand up to the rigours of surgery and help reduce the risk of cross-contamination.





# Material comparisons

Medline's drapes range is the broadest line in the industry. Innovative fabric technology and design features help ensure patient safety, improve drapeability and reduce preparation time in the operating theatre. Four ranges of fabrics are available, in order to provide all the features needed for all surgical specialties. A color coding will guide you through the different ranges.

## OPS™ Essential surgical drapes

Medline's Essential two-layered material not only absorbs liquids and body fluids, but its inner layer also provides an impervious and barrier against fluids and bacteria.



## OPS™ Ultimate surgical drapes

Made of a three-layered compound of different materials, the Ultimate drape lives up to its name—absorbing fluids throughout the entire drape, providing a barrier against fluids and bacteria, and ensuring patient comfort.

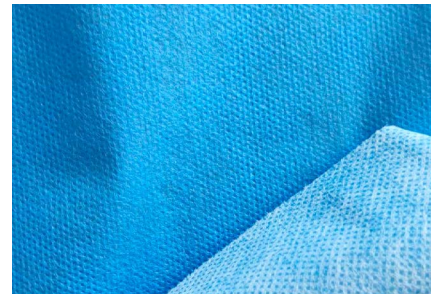

## OPS™ Advanced surgical drapes

Composed of five strong fibre layers, our SMS drapes provide drapeability, softness and a barrier against microorganisms. It also provides breathability to help with moisture management.

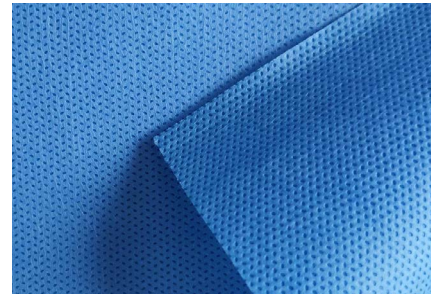

## Eclipse surgical drapes

Medline's textile-like spunlace fabric provides a breathable and soft solution. It also ensures there is a barrier against fluids and microbes.



## Invisishield transparent drapes

With Invisishield drapes, surgeons can easily view the area around incision sites, particularly on smaller animals. Made of a tear-resistant polyethylene and polyurethane, these drapes provide superb protection from fluids.





# Basic packs

## ES15303CE – Basic drape pack

40 ea/cs

Component	Description	Size	Comp qty.	Material
ES02C221	Drape sheet	90x75 cm	1	Bilaminate
ES02C215	Adhesive drape	45x50 cm	4	Bilaminate

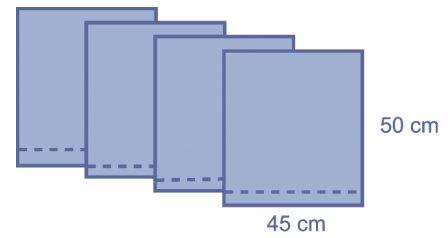

## ES15307CE – Basic drape pack

16 ea/cs

Component	Description	Size	Comp qty.	Material
ES02C221	Drape sheet	90x75 cm	1	Bilaminate
ES02C212	Adhesive drape	75x75 cm	4	Bilaminate

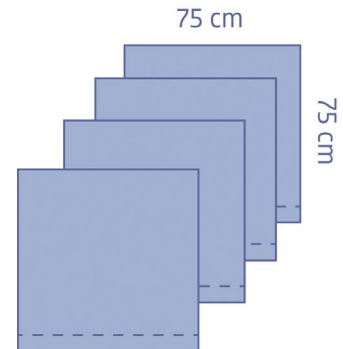

## ES30014CE – Basic drape pack

20 ea/cs

Component	Description	Size	Comp qty.	Material
7471	Absorbent hand towel	30x20 cm	2	Cellulose
ZHE750	OP-tape	9x50 cm	1	Spunlace
ES02C211	Adhesive drape	90x75 cm	4	Bilaminate
BTCM15	Back table cover, 50µm	140x190 cm	1	PP/PE
1025B	Wrap		1	SMS

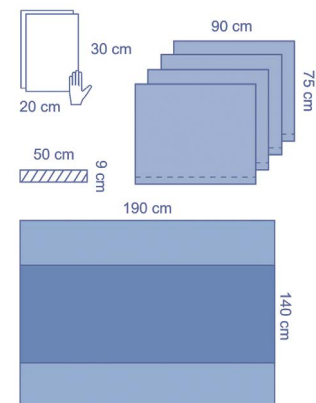

## TB30014CEA – Basic drape pack

16 ea/cs

Component	Description	Size	Comp qty.	Material
7471	Absorbent hand towel	30x20 cm	2	Cellulose
TB31300	Adhesive drape	98x75 cm	4	Trilaminate
BTCM15	Back table cover, 50µm	140x190 cm	1	PP/PE
1025B	Wrap		1	SMS

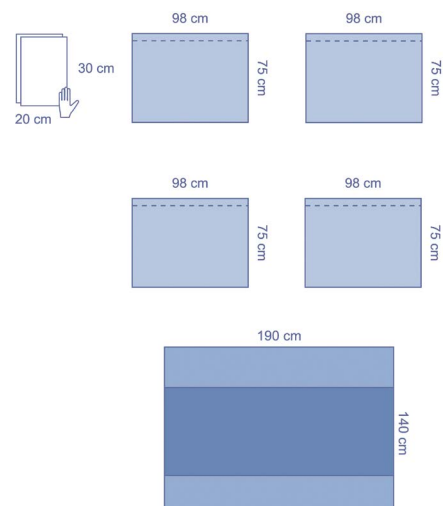

# Standard universal packs

## ES10110CE – Universal pack

10 ea/cs

Component	Description	Size	Comp qty.	Material
7471	Absorbent hand towels	30x20 cm	2	Cellulose
ZHE750	OP-tape	9x50 cm	1	Spunlace
ES02C211	Side drape	90x75 cm	2	Bilaminate
ES11600	Foot drape	175x175 cm	1	Bilaminate
ES10481	Head drape	260x160 cm	1	Bilaminate
BTCM15	Back table cover 50µm	140x190 cm	1	Blue PE
1025B	Wrap		1	SMS

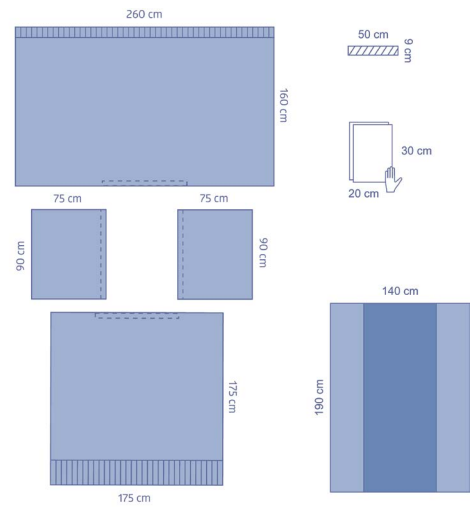

## ES10111CE – Universal pack

10 ea/cs

Component	Description	Size	Comp qty.	Material
7471	Absorbent hand towels	30x20 cm	4	Cellulose
7014WP	Hook and loop tube holder	2,5x14 cm	1	Polyester
ES02C2105	Drape sheet	98x75 cm	2	Bilaminate
ES11602	Foot drape	190x200 cm	1	Bilaminate
ES10483	Head drape	260x160 cm	1	Bilaminate
BTCM15	Back table cover 50µm	140x190 cm	1	Blue PE
1025B	Wrap		1	SMS

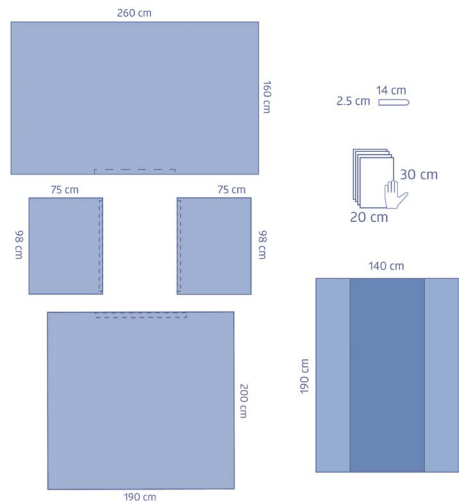

## ES10115CE – Universal pack

12 ea/cs

Component	Description	Size	Comp qty.	Material
8339	Mayo stand cover	80x142 cm	1	Blue PE
7471	Absorbent hand towels	30x20 cm	4	Cellulose
ZHE750	OP-tape	9x50 cm	1	Spunlace
ES02C211	Side drape	90x75 cm	2	Bilaminate
ES11600	Foot drape	175x175 cm	1	Bilaminate
ES10482	Head drape	240x150 cm	1	Bilaminate
BTCM15	Back table cover 50µm	140x190 cm	1	Blue PE

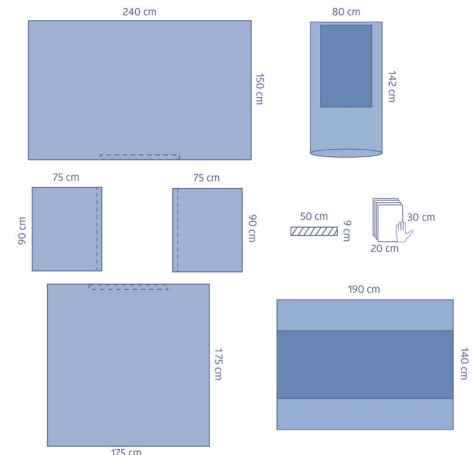

**ES10114CE – Universal pack**

10 ea/cs

Component	Description	Size	Comp qty.	Material
7471	Absorbent hand towels	30x20 cm	2	Cellulose
ZHE750	OP-tape	9x50 cm	3	Spunlace
8339	Mayo stand cover	80x142 cm	1	Blue PE
ES02C211	Side drape	90x75 cm	2	Bilaminate
ES11600	Foot drape	175x175 cm	1	Bilaminate
ES10481	Head drape	260x160 cm	1	Bilaminate
BTCM15	Back table cover 50µm	140x190 cm	1	Blue PE

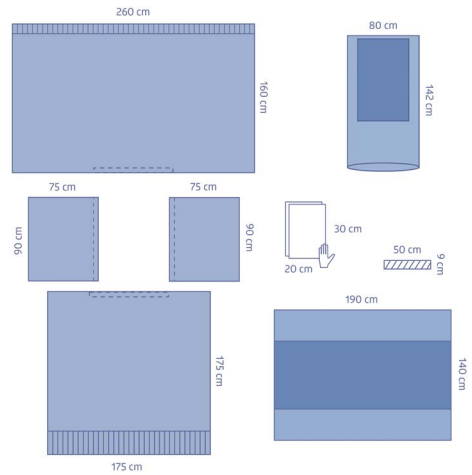

**ES10116CE – Universal pack large dimensions**

10 ea/cs

Component	Description	Size	Comp qty.	Material
8339	Mayo stand cover	80x142 cm	1	Blue PE
7471	Absorbent hand towels	30x20 cm	2	Cellulose
ZHE750	OP-tape	9x50 cm	1	Spunlace
ES10428	Side drape	110x100 cm	2	Bilaminate
ES11601	Foot drape	190x190 cm	1	Bilaminate
ES10483	Head drape	260x160 cm	1	Bilaminate
BTCM15	Back table cover 50µm	140x190 cm	1	Blue PE

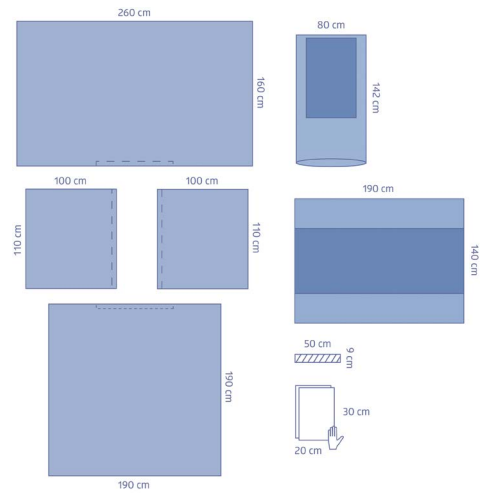

**ES10117CE – Universal pack large dimensions**

10 ea/cs

Component	Description	Size	Comp qty.	Material
7471	Absorbent hand towels	30x20 cm	4	Cellulose
ZHE750	OP-tape	9x50 cm	1	Spunlace
ES02C210	Side drape	98x75 cm	2	Bilaminate
ES11603	Foot drape	240x200 cm	1	Bilaminate
ES10483	Head drape	260x160 cm	1	Bilaminate
BTCM15	Back table cover 50µm	140x190 cm	1	Blue PE
1025B	Wrap		1	SMS

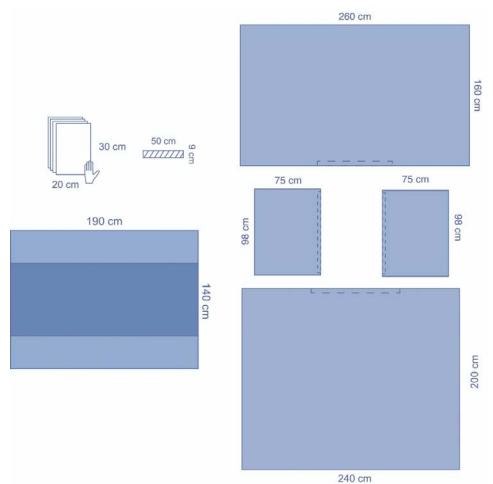

### TB30110CE – Universal pack

8 ea/cs

Component	Description	Size	Comp qty.	Material
7471	Absorbent hand towels	30x20 cm	4	Cellulose
7014WP	Hook and loop tube holder	2,5x14 cm	1	Polyester
TB31300	Side drape	98x75 cm	2	Trilaminare
TB31600	Foot drape	196x200 cm	1	Trilaminare
TB31900	Head drape	260x160 cm	1	Trilaminare
BTCM15	Back table cover 50µm	140x190 cm	1	Blue PE
1025B	Wrap		1	SMS

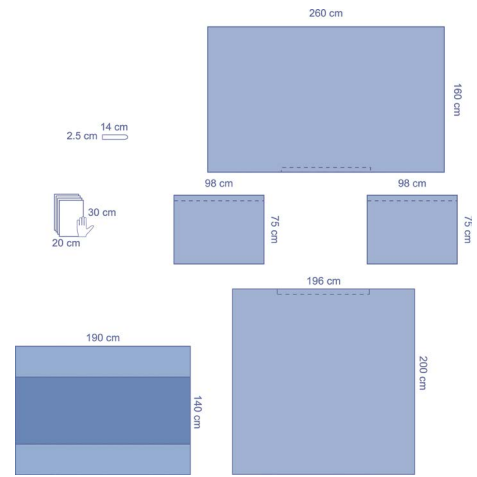

### TB30114CE – Universal pack

8 ea/cs

Component	Description	Size	Comp qty.	Material
7471	Absorbent hand towels	30x20 cm	4	Cellulose
7014WP	Hook and loop tube holder	2,5x14 cm	1	Polyester
8339	Mayo stand cover	80x142 cm	1	Blue PE
TB31300	Side drape	98x75 cm	2	Trilaminare
TB31600	Foot drape	196x200 cm	1	Trilaminare
TB31900	Head drape	260x160 cm	1	Trilaminare
BTCM15	Back table cover 50µm	140x190 cm	1	Blue PE

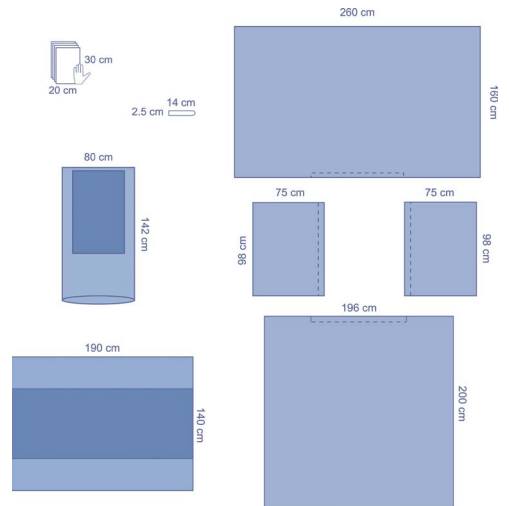

### ES10175CE – Pædiatrics universal pack

10 ea/cs

Component	Description	Size	Comp qty.	Material
8339	Mayo stand cover	80x142 cm	1	Blue PE
ZHE750	OP-tape	9x50 cm	1	Spunlace
7471	Absorbent hand towels	30x20 cm	4	Cellulose
ES02C2125	Side drape	75x75 cm	2	Bilaminare
ES10470	Foot drape	175x190 cm	1	Bilaminare
ES104835	Head drape	260x160 cm	1	Bilaminare
BTCM15	Back table cover 50µm	140x190 cm	1	Blue PE

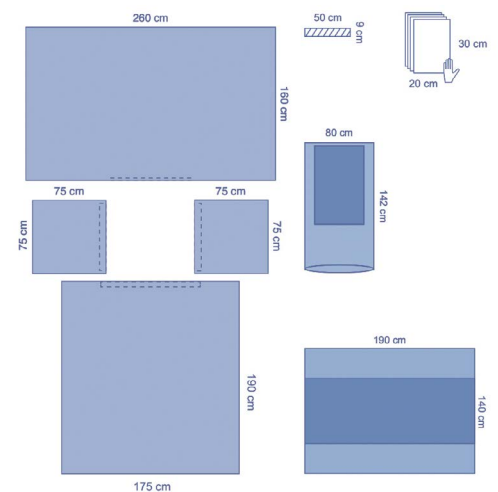



# Reinforced universal packs

## ES29104CE – Universal pack

8 ea/cs

Component	Description	Size	Comp qty.	Material
7471	Absorbent hand towels	30x20 cm	4	Cellulose
7014WP	Hook and loop tube holder	2,5x14 cm	1	Polyester
ZHE750	OP-tape	9x50 cm	1	Spunlace
ES29443	Side drape, reinforced	90x75 cm	2	Bilaminate
ES29470	Foot drape, reinforced	175x190 cm	1	Bilaminate
ES29483	Head drape, reinforced	240x150 cm	1	Bilaminate
BTCM15	Back table cover 50µm	140x190 cm	1	Blue PE
1025B	Wrap		1	SMS

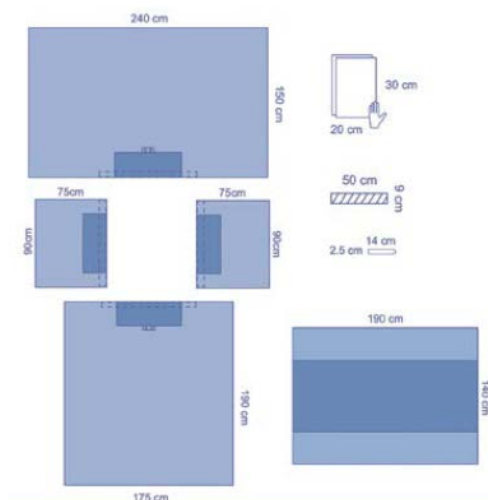

## ES29105CE – Universal pack

8 ea/cs

Component	Description	Size	Comp qty.	Material
7471	Absorbent hand towels	30x20 cm	4	Cellulose
7014WP	Hook and loop tube holder	2,5x14 cm	1	Polyester
ZHE750	OP-tape	9x50 cm	1	Spunlace
ES29444	Side drape, reinforced	110x95 cm	1	Bilaminate
ES29471	Foot drape, reinforced	200x200 cm	1	Bilaminate
ES29480	Head drape, reinforced	260x170 cm	1	Bilaminate
BTCM15	Back table cover 50µm	140x190 cm	1	Blue PE
1025B	Wrap		1	SMS

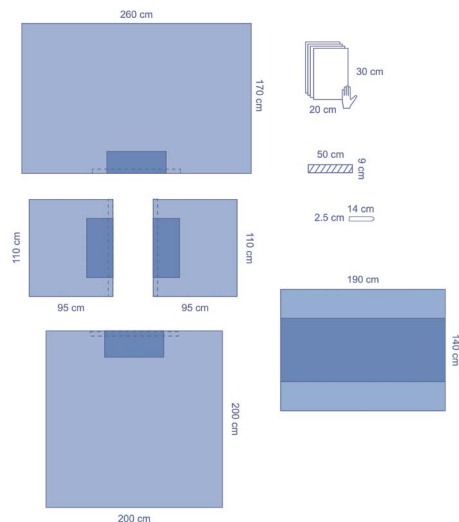

## ES29106CE – Universal pack with armboard covers 10 ea/cs

Component	Description	Size	Comp qty.	Material
7471	Absorbent hand towels	30x20 cm	2	Cellulose
ZHE750	OP-tape	9x50 cm	1	Spunlace
ES29444	Side drape, reinforced	110x95 cm	2	Bilaminate
ES29471	Foot drape, reinforced	200x200 cm	1	Bilaminate
ES2931	Head drape, reinforced, armboard cover	269x182 cm	1	Bilaminate
BTCM15	Back table cover 50µm	140x190 cm	1	Blue PE
1025B	Wrap		1	SMS

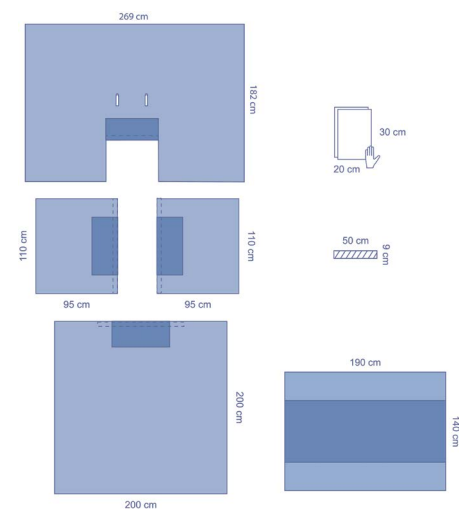

**ES29109CE – Universal pack large dimensions**

8 ea/cs

Component	Description	Size	Comp qty.	Material
7471	Absorbent hand towels	30x20 cm	2	Cellulose
ZHE750	OP-tape	9x50 cm	1	Spunlace
7014WP	Hook and loop tube holder	2,5x14 cm	1	Polyester
ES2980	Head drape, reinforced, long adhesive	300x183 cm	1	Bilaminate
ES29474	Foot drape, reinforced	190x240 cm	1	Bilaminate
ES29444	Side drape, reinforced	110x95 cm	2	Bilaminate
BTCM15	Back table cover 50µm	140x190 cm	1	Blue PE
1025B	Wrap		1	SMS

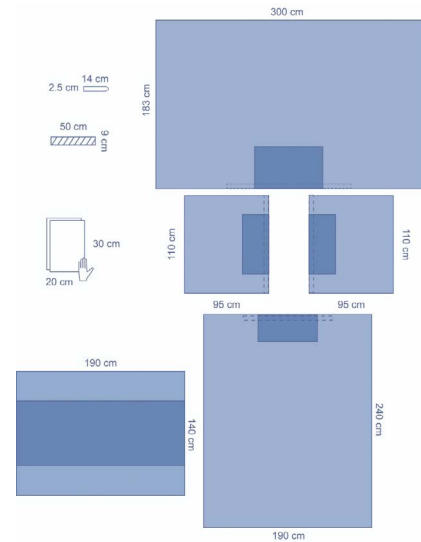

**ES29115CE – Universal pack**

8 ea/cs

Component	Description	Size	Comp qty.	Material
7471	Absorbent hand towels	30x20 cm	4	Cellulose
ZHE750	OP-tape	9x50 cm	1	Spunlace
8339	Mayo stand cover	80x142 cm	1	Blue PE
ES29443	Side drape, reinforced	90x75 cm	2	Bilaminate
ES29470	Foot drape, reinforced	175x190 cm	1	Bilaminate
ES29483	Head drape, reinforced	240x150 cm	1	Bilaminate
TC060	Back table cover 50µm	152x190 cm	1	Blue PE

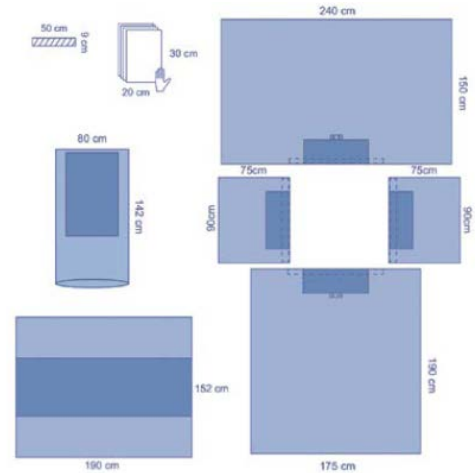

**ES29114CE – Universal pack**

10 ea/cs

Component	Description	Size	Comp qty.	Material
8339	Mayo stand cover	80x142 cm	1	Blue PE
7471	Absorbent hand towels	30x20 cm	4	Cellulose
7014WP	Hook and loop tube holder	2,5x14 cm	1	Polyester
ZHE750	OP-tape	9x50 cm	1	Spunlace
ES29444	Side drape, reinforced	110x95 cm	2	Bilaminate
ES29471	Foot drape, reinforced	200x200 cm	1	Bilaminate
ES29480	Head drape, reinforced	260x170 cm	1	Bilaminate
TC060	Back table cover 50µm	152x190 cm	1	Blue PE

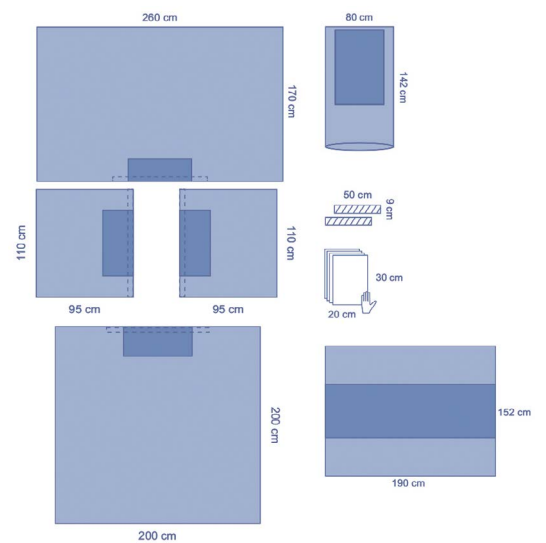

## ES29108CE – Universal pack large dimensions

8 ea/cs

Component	Description	Size	Comp qty.	Material
8339	Mayo stand cover	80x142 cm	1	Blue PE
7471	Absorbent hand towels	30x20 cm	4	Cellulose
7014WP	Hook and loop tube holder	2,5x14 cm	1	Polyester
ZHE750	OP-tape	9x50 cm	1	Spunlace
ES29444	Side drape, reinforced	110x95 cm	2	Bilaminare
ES29471	Foot drape, reinforced	200x200 cm	1	Bilaminare
ES29482	Head drape, reinforced, long adhesive	300x170 cm	1	Bilaminare
TC060	Back table cover 50µm	152x190 cm	1	Blue PE

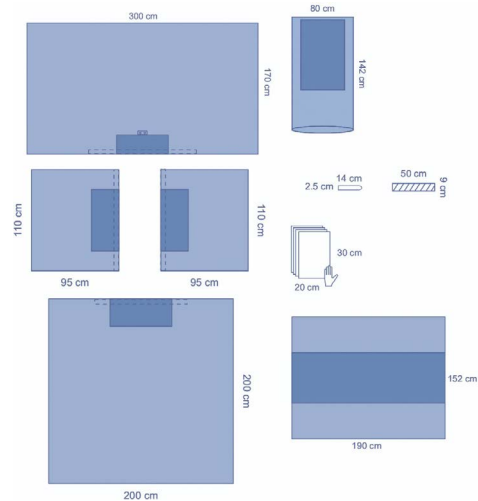

## ES29906CE – Universal pack large dimensions

8 ea/cs

Component	Description	Size	Comp qty.	Material
7471	Absorbent hand towels	30x20 cm	2	Cellulose
BTCM16	Back table cover 50µm, folded	140x190 cm	1	Blue PE
O4A039	Instrument pouch, 1 compartment	33x41 cm	1	PE
ZHE750	OP-tape	9x50 cm	2	Spunlace
ES29439	Side drape, reinforced	112x98 cm	2	Bilaminare
ES2980	Head drape, reinforced, long adhesive	300x183 cm	1	Bilaminare
ES29479	Foot drape, reinforced	254x183 cm	1	Bilaminare
BTCL35	Back table cover 90µm	160x240 cm	1	Blue PE
1025B	Wrap		1	SMS

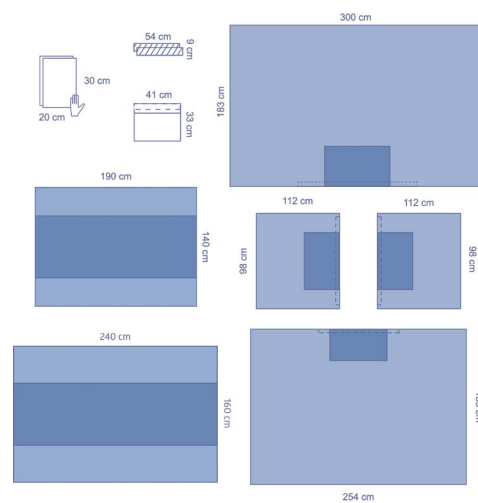

## ES29104GCE – Universal pack with surgical gowns

6 ea/cs

Component	Description	Size	Comp qty.	Material
E3510	UltraGard OR gown, polyreinforced	XL, 120 cm	1	SMS
7014WP	Hook and loop tube holder	2,5x14 cm	1	Polyester
ZHE750	OP-tape	9x50 cm	1	Spunlace
7471	Absorbent hand towels	30x20 cm	4	Cellulose
E3540	UltraGard OR gown, polyreinforced	XL, 140 cm	2	SMS
8339	Mayo stand cover	80x142 cm	1	Blue PE
ES29443	Side drape, reinforced	90x75 cm	2	Bilaminare
ES294701	Foot drape, reinforced	175x200 cm	1	Bilaminare
ES29483	Head drape, reinforced	240x150 cm	1	Bilaminare
BTCM15	Back table cover 50µm	140x190 cm	1	Blue PE
1025B	Wrap		1	SMS

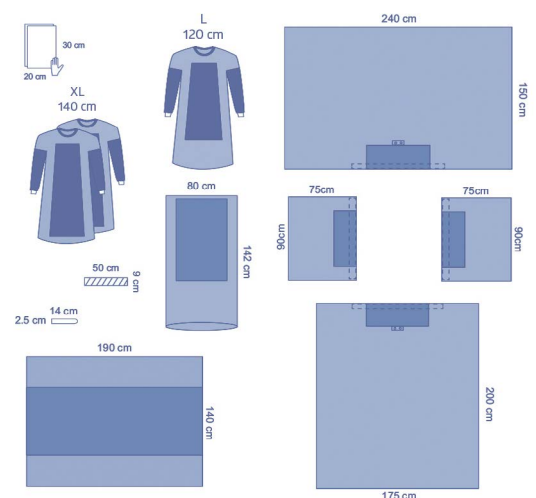

### CPE29007CE

– Universal pack with MDD/PPE surgical gowns

4 ea/cs

Component	Description	Size	Comp qty.	Material
S3540P	Essential OR gown, polyreinforced, MD/PPE	XL, 140 cm	1	SMS
8530	Absorbent hand towels	39x30 cm	14	Cellulose
S3513P	Essential OR gown, polyreinforced, MD/PPE	XL, 150 cm	2	SMS
8339	Mayo stand cover	80x142 cm	1	Blue PE
ZHE750	OP-tape	9x50 cm	2	Spunlace
7023W	Hook and loop tube holder	2,5x23 cm	2	Polyester
04A036	Instrument pouch, 2 compartments	33x41 cm	1	Clear PE
ES29444	Side drape, reinforced	110x95 cm	2	Bilaminate
ES29471	Foot drape, reinforced	200x200 cm	1	Bilaminate
ES29480	Head drape, reinforced	260x170 cm	1	Bilaminate
BTCL25	Back table cover, 75µm	160x240 cm	1	Blue PE
1025B	Wrap		1	SMS

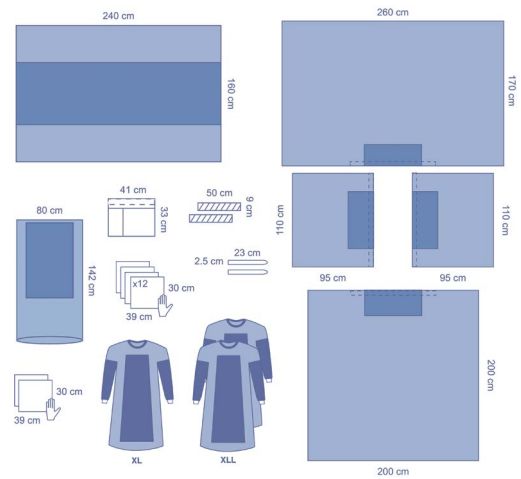

### TB29106CE – Universal pack with armboard covers

8 ea/cs

Component	Description	Size	Comp qty.	Material
7471	Absorbent hand towels	30x20 cm	4	Cellulose
7014WP	Hook and loop tube holder	2,5x14 cm	1	Polyester
TB29441	Side drape, reinforced	100x98 cm	2	Trilaminare
TB29473	Foot drape, reinforced	196x200 cm	1	Trilaminare
TB29481	Head drape, reinforced	260x160 cm	1	Trilaminare
BTCM15	Back table cover 50µm	140x190 cm	1	Blue PE

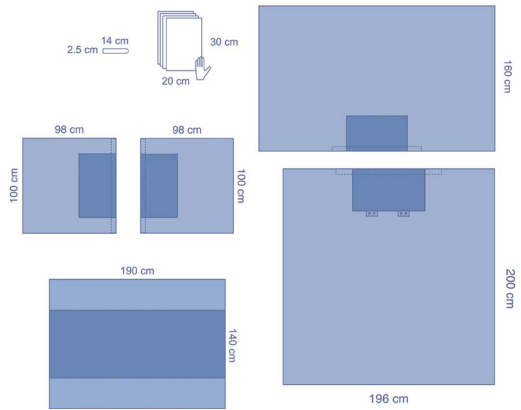

### TB29105CE – Universal pack large dimensions

6 ea/cs

Component	Description	Size	Comp qty.	Material
7471	Absorbent hand towels	30x20 cm	4	Cellulose
7014WP	Hook and loop tube holder	2,5x14 cm	2	Polyester
TB29444	Side drape, reinforced	120x98 cm	2	Trilaminare
TB29471	Foot drape, reinforced	210x196 cm	1	Trilaminare
TB29480	Head drape, reinforced	260x160 cm	1	Trilaminare
BTCM15	Back table cover 50µm	140x190 cm	1	Blue PE
1025B	Wrap		1	SMS

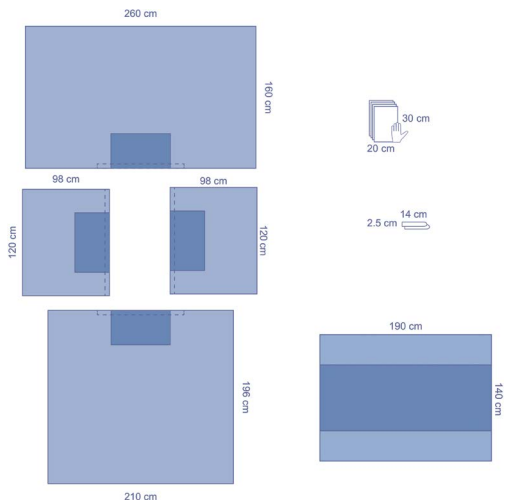



## TB29114CE – Universal pack

6 ea/cs

Component	Description	Size	Comp qty.	Material
7471	Absorbent hand towels	30x20 cm	4	Cellulose
7014WP	Hook and loop tube holder	2,5x14 cm	1	Polyester
8339	Mayo stand cover	80x142 cm	1	Blue PE
TB29441	Side drape, reinforced	100x98 cm	2	Trilaminare
TB29473	Foot drape, reinforced	196x200 cm	1	Trilaminare
TB29481	Head drape, reinforced	260x160 cm	1	Trilaminare
BTCM15	Back table cover 50µm	140x190 cm	1	Blue PE
1025B	Wrap		1	SMS

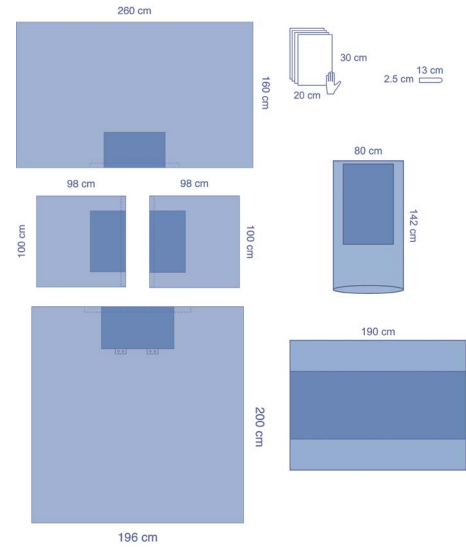

## TB29005CE – Universal pack large dimensions

4 ea/cs

Component	Description	Size	Comp qty.	Material
8339	Mayo stand cover	80x142 cm	1	Blue PE
8520	Absorbent hand towels	58x39 cm	2	Cellulose
29960	Suture bag	25x34 cm	1	PE
ZHE750	OP-tape	9x50 cm	1	Spunlace
TB29428	Side drape, reinforced	112x98 cm	2	Trilaminare
TB29463	Foot drape, reinforced	190x183 cm	1	Trilaminare
TB2980	Head drape, reinforced, long adhesive	300 x 183cm	1	Trilaminare
BTCL25	Back table cover, 75µm	160x240 cm	1	Blue PE

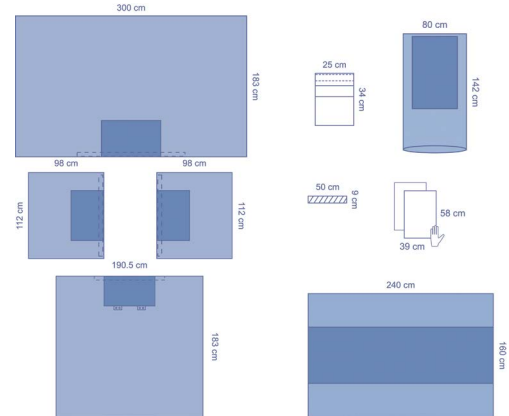

## CPU29002CE – Universal pack large dimensions

6 ea/cs

Component	Description	Size	Comp qty.	Material
8530	Absorbent hand towels	39x30 cm	4	Cellulose
8339	Mayo stand cover	80x142 cm	1	Blue PE
04A036	Instrument pouch, 2 compartments	33x41 cm	1	PE
S3513P	Essential OR gown, polyreinforced, MD/PPE	XL, 150 cm	1	SMS
ZHE750	OP-tape	9x50 cm	2	Spunlace
TB29444	Side drape, reinforced	120x98 cm	1	Trilaminare
TB29476	Head drape, reinforced	254x183 cm	1	Trilaminare
TB29473	Foot drape, reinforced	196x200 cm	1	Trilaminare
BTCL25	Back table cover, 75µm	160x240 cm	1	Blue PE
1025B	Wrap		1	SMS

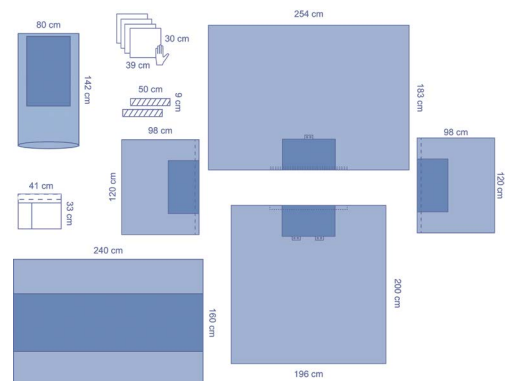

### SM29105CE – Universal pack

5 ea/cs

Component	Description	Size	Comp qty.	Material
SPTe-HNTOM	Absorbent hand towels	34x36 cm	4	Cellulose
SPTe-SIDSM4	Side drape, reinforced	112x102 cm	2	SMS
SPTe-FTDSM5	Foot drape, reinforced	196x196 cm	1	SMS
SPTe-HEDSM8	Head drape, reinforced	260x152 cm	1	SMS
TC060	Back table cover 50µm	152x190 cm	1	Blue PE
1025B	Wrap		1	SMS

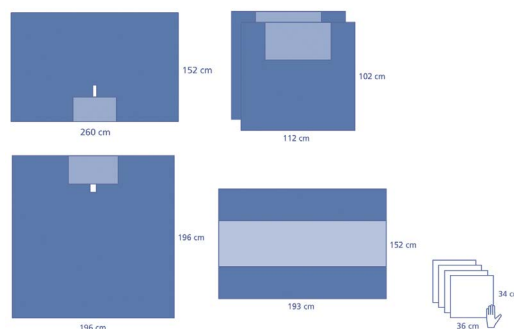

### DYJPEUNPSM2 – Universal pack

5 ea/cs

Component	Description	Size	Comp qty.	Material
8339	Mayo stand cover	80x142 cm	1	Blue PE
SPTe-HNTOM	Absorbent hand towels	34x36 cm	4	Cellulose
SPTe-SIDSM2	Side drape, reinforced	93x75 cm	2	SMS
SPTe-FTDSM1	Foot drape, reinforced	183x175 cm	1	SMS
SPTe-HEDSM2	Head drape, reinforced	250x152 cm	1	SMS
TC060	Back table cover 50µm	152x190 cm	1	Blue PE

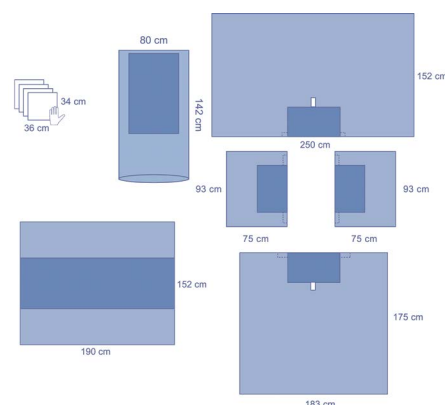

### DYJPEUNPSM1 – Universal pack

5 ea/cs

Component	Description	Size	Comp qty.	Material
8339	Mayo stand cover	80x142 cm	1	Blue PE
SPTe-SIDSM1	Side drape, reinforced	112x102 cm	2	SMS
SPTe-FTDSM1	Foot drape, reinforced	183x175 cm	1	SMS
SPTe-HEDSM4	Head drape, reinforced	260x157 cm	1	SMS
TC060	Back table cover 50µm	152x190 cm	1	Blue PE

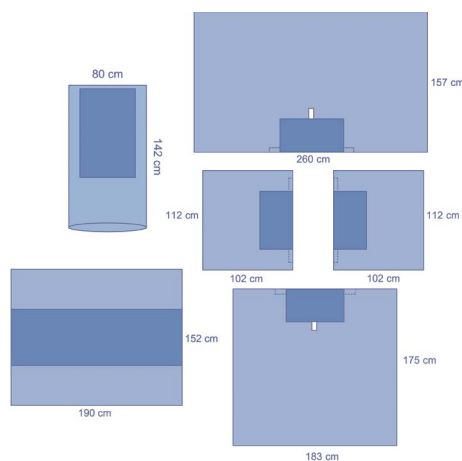

### DYJPEUNMPSM1 – Universal pack

5 ea/cs

Component	Description	Size	Comp qty.	Material
8339	Mayo stand cover	80x142 cm	1	Blue PE
SPTe-SIDSM1	Side drape, reinforced	112x102 cm	2	SMS
SPTe-FTDSM1	Foot drape, reinforced	183x175 cm	1	SMS
SPTe-HEDSM1	Head drape, reinforced	300x183 cm	1	SMS
TC060	Back table cover 50µm	152x190 cm	1	Blue PE

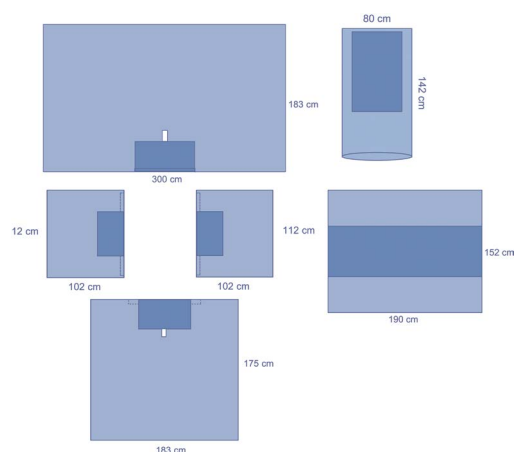

## ES29103CE – Paediatric universal pack

8 ea/cs

Component	Description	Size	Comp qty.	Material
7471	Absorbent hand towels	30x20 cm	2	Cellulose
7014WP	Hook and loop tube holder	2,5x14 cm	1	Polyester
ZHE750	OP-tape	9x50 cm	1	Spunlace
ES294435	Side drape, reinforced	90x75 cm	2	Bilaminare
ES294705	Foot drape, reinforced	175x190 cm	1	Bilaminare
ES294835	Head drape, reinforced	240x150 cm	1	Bilaminare
BTCM15	Back table cover 50µm	140x190 cm	1	Blue PE
1025B	Wrap		1	SMS

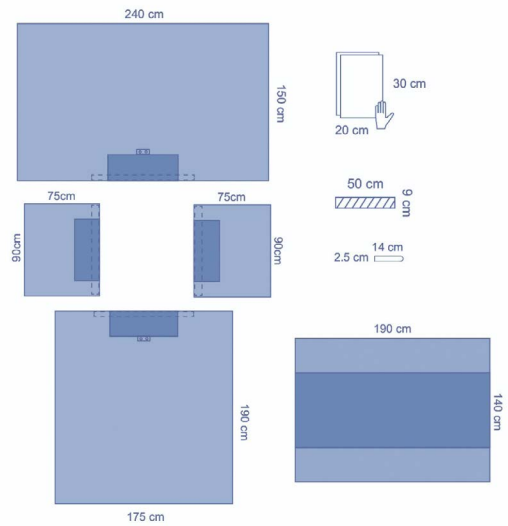

## DYJPEPDUPSM – Paediatric universal pack

8 ea/cs

Component	Description	Size	Comp qty.	Material
8339	Mayo stand cover	80x142 cm	1	Blue PE
SPTE-HNTOM	Absorbent hand towels	34x36 cm	2	Cellulose
SPTE-SIDSM3	Side drape, reinforced	102x75 cm	1	SMS
SPTE-FTDSM2	Foot drape, reinforced	190x183 cm	1	SMS
SPTE-HEDSM3	Head drape, reinforced	250x157 cm	1	SMS
TC060	Back table cover 50µm	152x190 cm	1	Blue PE

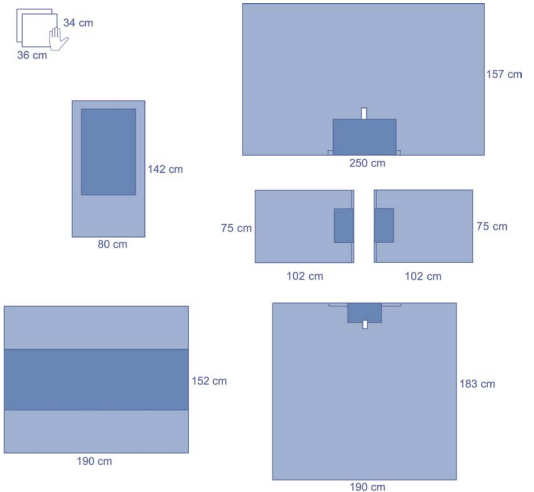

## CP29174CE – Paediatric universal pack

10 ea/cs

Component	Description	Size	Comp qty.	Material
8530	Absorbent hand towels	39x30 cm	1	Cellulose
04A035	OP-tape	8x40 cm	2	Clear PE
F2952	Side drape, reinforced	123x75 cm	2	Spunlace
F2939	Adhesive drape, reinforced	112x183 cm	2	Spunlace
BTCM15	Back table cover 50µm	140x190 cm	1	Blue PE
1025B	Wrap		1	SMS

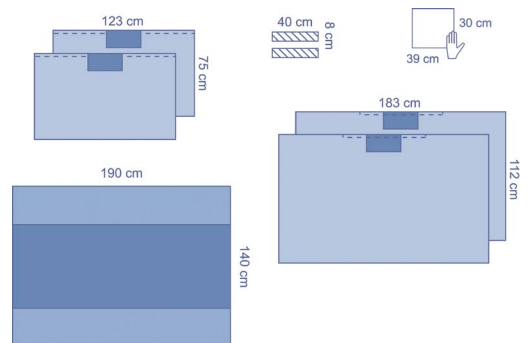

# Abdominal and thoracic drapes & packs

## TB29492CE – Paediatric laparotomy drape 18 ea/cs

Component	Description	Size	Comp qty.	Material
TB29492	Paediatric laparotomy drape, adhesive fenestration 15x15 cm	196x274 cm	1	Trilaminare
1025B	Wrap		1	SMS

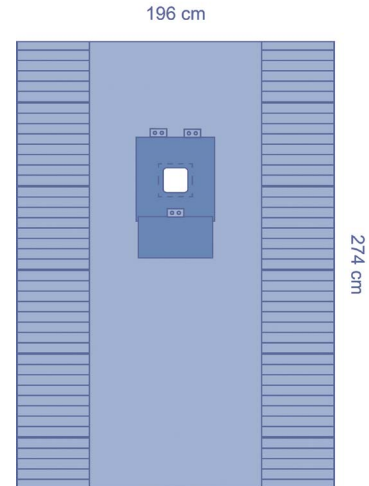

## TB29493CE – Paediatric laparotomy drape 15 ea/cs

Component	Description	Size	Comp qty.	Material
TB29493	Paediatric laparotomy drape, adhesive fenestration 15x15 cm	196/254x286cm	1	Trilaminare
1025B	Wrap		1	SMS

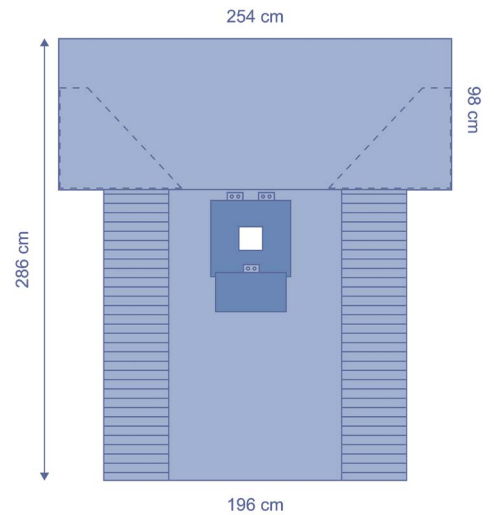

## TB29410CE – Laparotomy drape 12 ea/cs

Component	Description	Size	Comp qty.	Material
TB29410	Laparotomy drape, adhesive fenestration 12x32 cm	196/254x310 cm	1	Trilaminare
1025B	Wrap		1	SMS

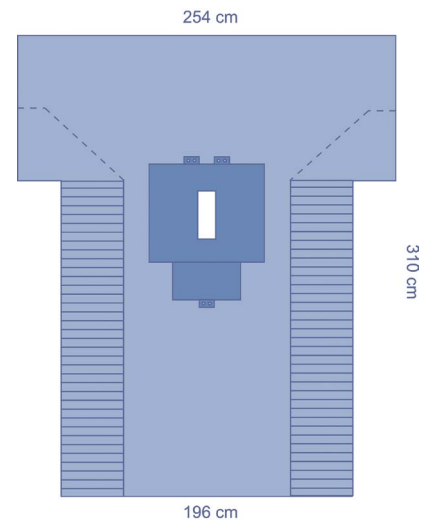



## 29511CEA – Laparotomy drape

10 ea/cs

Component	Description	Size	Comp qty.	Material
29511	Laparotomy drape, incise fenestration 23x37 cm	196/254x314 cm	1	Spunlace
1025B	Wrap		1	SMS

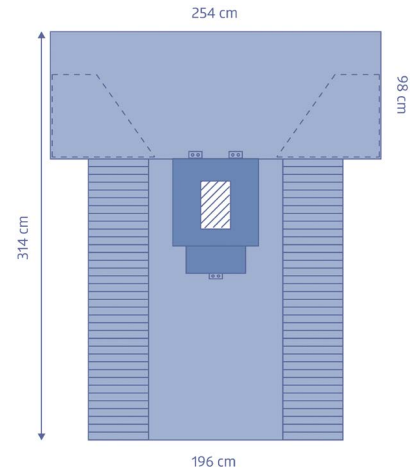

## TB29138CE – Laparotomy pack

8 ea/cs

Component	Description	Size	Comp qty.	Material
8339	Mayo stand cover	80x142 cm	1	PP/PE
05144	Suture bag	16x31 cm	1	Paper
8520	Absorbent hand towel	58x39 cm	1	Cellulose
TB29410	Laparotomy drape, adhesive fenestration 12x32 cm	196/254x310 cm	1	Trilaminate
BTCM15	Back table cover, 50µm	140x190 cm	1	PP/PE

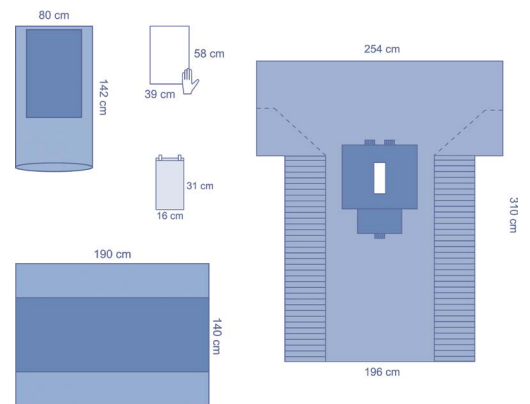

## TB9429CE – Laparoscopy drape

7 ea/cs

Component	Description	Size	Comp qty.	Material
TB9429	Laparoscopy drape, adhesive fenestration 25x28cm, with leggings	196/269x304 cm	1	Trilaminate
1025B	Wrap		1	SMS

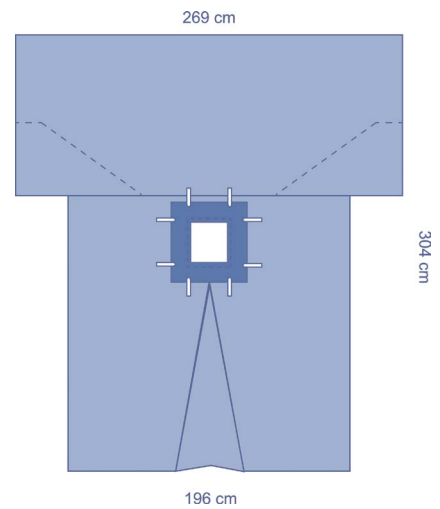

### DYJPELAPPSM – Laparoscopy pack

8 ea/cs

Component	Description	Size	Comp qty.	Material
8339	Mayo stand cover	80x142 cm	1	PP/PE
LCDSM	Laparoscopy drape, adhesive fenestration 30x33 cm, with leggings	195/254x292 cm	1	SMS
TC060	Back table cover, 50µm	152x190 cm	1	PP/PE

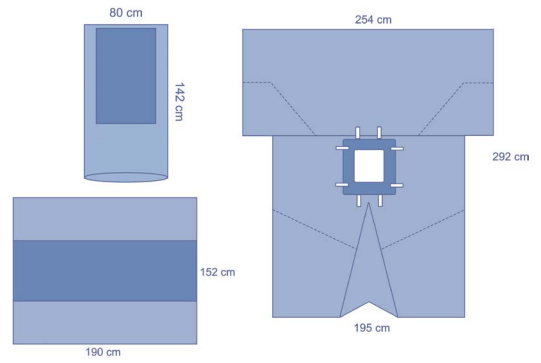

### TB9432CE – Laparoscopy pack

7 ea/cs

Component	Description	Size	Comp qty.	Material
TB9429	Laparoscopy drape, adhesive fenestration 25x28cm, with leggings	196/269x304 cm	1	Trilaminare
8520	Absorbent hand towel	58x39 cm	2	Cellulose
BTCM15	Back table cover, 50µm	140x190 cm	1	PP/PE
1025B	Wrap		1	SMS

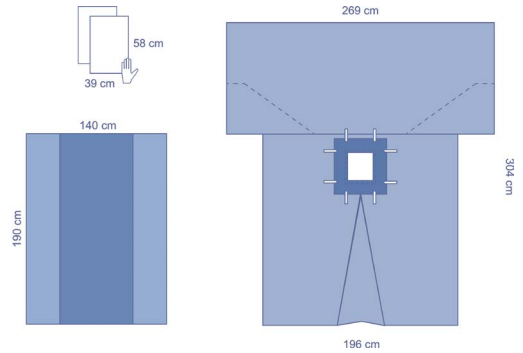

### TB9427CE – Laparoscopy pack

6 ea/cs

Component	Description	Size	Comp qty.	Material
8339	Mayo stand cover	80x142 cm	1	PP/PE
TB9429	Laparoscopy drape, adhesive fenestration 25x28cm, with leggings	196/269x304 cm	1	Trilaminare
BTCM15	Back table cover, 50µm	140x190 cm	1	PP/PE

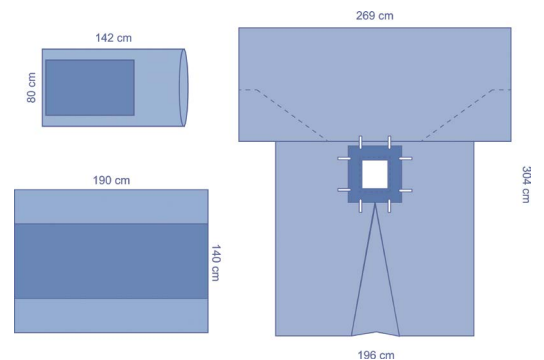

## TB9458CE – Laparoscopy drape

10 ea/cs

Component	Description	Size	Comp qty.	Material
TB9458	Laparoscopy drape, adhesive fenestration 28x36 cm	196/254x314 cm	1	Trilaminar
1025B	Wrap		1	SMS

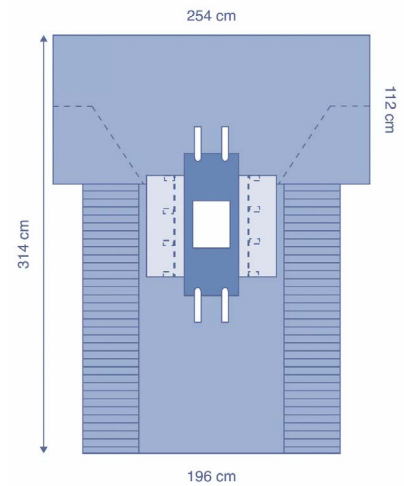

## ES1050CE – Laparoscopy drape

8 ea/cs

Component	Description	Size	Comp qty.	Material
ES10501	Laparoscopy drape, fenestrated incise film 34x38 cm	200/255x331 cm	1	Bilaminar
1025B	Wrap		1	SMS

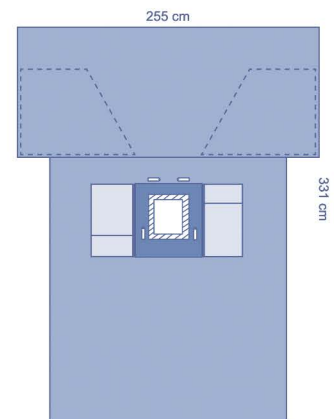

## ES10501CE – Laparoscopy pack

7 ea/cs

Component	Description	Size	Comp qty.	Material
VC594	Camera cover	13x240 cm	1	Clear PE
7471	Absorbent hand towel	30x20 cm	4	Cellulose
ES10501	Laparoscopy drape, fenestrated incise film 34x38 cm	200/255x331 cm	1	Bilaminar
BTCM15	Back table cover, 50µm	140x190 cm	1	PP/PE
1025B	Wrap		1	SMS

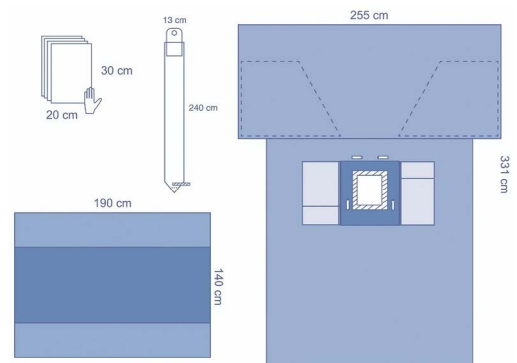

### ES10499CE – Laparoscopy pack

8 ea/cs

Component	Description	Size	Comp qty.	Material
7471	Absorbent hand towel	30x20 cm	4	Cellulose
7023W	Hook and loop tube holder	2.5x23 cm	1	Polyester
8339	Mayo stand cover	80x142 cm	1	PP/PE
VC594	Camera cover	13x240 cm	1	Clear PE
ES10498	Laparoscopy drape, adhesive fenestration 30x35cm	301/302x255 cm	1	Bilaminare
BTCM15	Back table cover, 50µm	140x190 cm	1	PP/PE

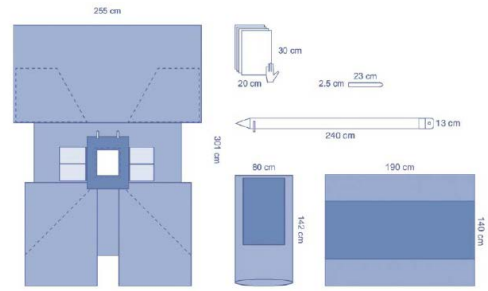

### TB29142CEA – Laparoscopy pack

10 ea/cs

Component	Description	Size	Comp qty.	Material
8520	Absorbent hand towel	58x39 cm	1	Cellulose
8420	Leggings	79x140 cm	2	SMS
TB29402	Laparoscopy drape, adhesive fenestrations 20x20 cm/ 8x15 cm	248/98 x 246 cm	1	Trilaminare
BTCL15	Back table cover, 50µm	125x230 cm	1	PP/PE

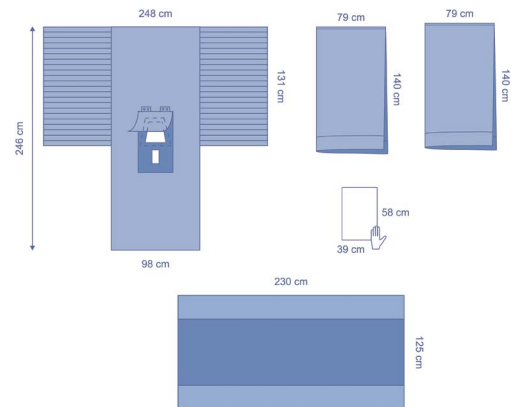

### 29421CEA – Laparoscopy pack

8 ea/cs

Component	Description	Size	Comp qty.	Material
7471	Absorbent hand towel	30x20 cm	2	Cellulose
7014WP	Hook and loop tube holder	2,5x14 cm	2	Polyester
8420	Leggings	79x140 cm	2	SMS
9694	Laparoscopy drape, adhesive fenestration 35x27 cm	196x240 cm	1	Spunlace
BTCM15	Back table cover, 50µm	140x190 cm	1	PP/PE
1025B	Wrap		1	SMS

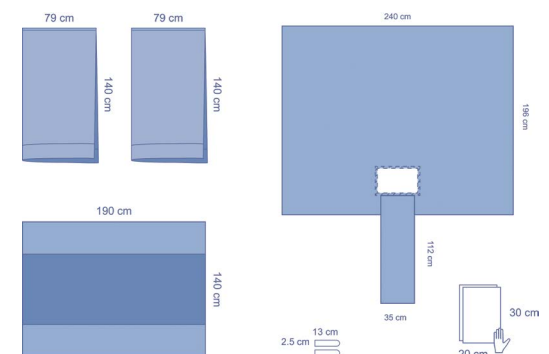



## ES10496CE – Laparoscopy pack

7 ea/cs

Component	Description	Size	Comp qty.	Material
8520	Absorbent hand towel	58x39 cm	2	Cellulose
7023W	Hook and loop tube holder	2,5x23 cm	1	Polyester
ZHE750	OP-tape	9x50 cm	1	Spunlace
258305	Instrument pouch, 2 compartments, clear PE	61x42.5 cm	1	Clear PE
ES10496	Laparoscopic drape, adhesive fenestrations 30x34cm/15x18cm	255x306 cm	1	Bilaminare
BTCM15	Back table cover, 50µm	140x190 cm	1	PP/PE
1025B	Wrap		1	SMS

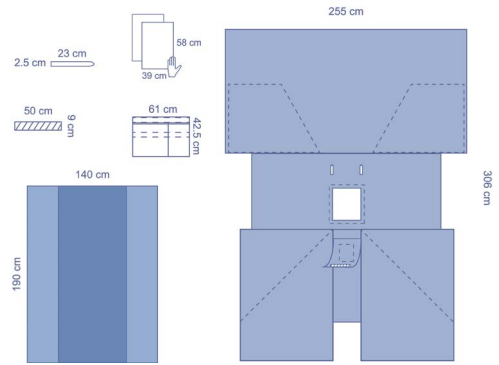

## TB29496CE – Laparoscopy pack

5 ea/cs

Component	Description	Size	Comp qty.	Material
8520	Absorbent hand towel	58x39 cm	2	Cellulose
TB29496	Laparoscopic drape, adhesive fenestrations 34x38cm/11x14cm, incise film	255x301 cm	1	Trilaminare
BTCM15	Back table cover, 50µm	140x190 cm	1	PP/PE
1025B	Wrap		1	SMS

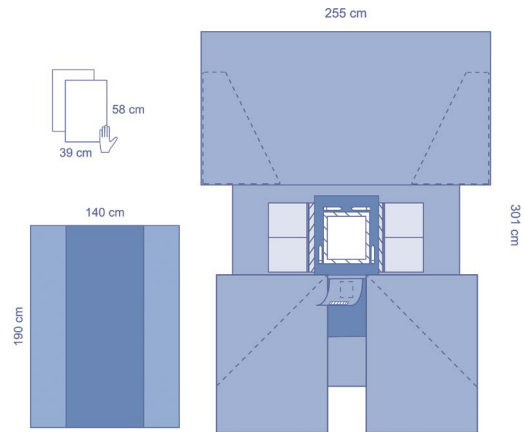

## ES29496CE – Laparoscopy pack

6 ea/cs

Component	Description	Size	Comp qty.	Material
7471	Absorbent hand towel	30x20 cm	2	Cellulose
ZHE750	OP-tape	9x50 cm	1	Spunlace
ES02C211	Adhesive drape	90x75 cm	1	Bilaminare
ES29496	Laparoscopic drape, adhesive fenestrations 30x34cm/15x18cm, incise film	255x301 cm	1	Bilaminare
BTCM15	Back table cover, 50µm	140x190 cm	1	PP/PE
1025B	Wrap		1	SMS

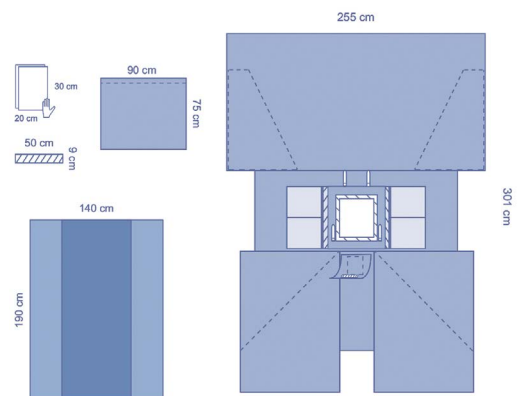

### ES27050CE – Laparoscopy pack

6 ea/cs

Component	Description	Size	Comp qty.	Material
7471	Absorbent hand towel	30x20 cm	2	Cellulose
8339	Mayo stand cover	80x142 cm	1	PP/PE
ZHE750	OP-tape	9x50 cm	1	Spunlace
ES02C211	Adhesive drape	90x75 cm	1	Bilaminate
ES29496	Laparoscopic drape, adhesive fenestrations 30x34cm/15x18cm, incise film	255x301 cm	1	Bilaminate
BTCM15	Back table cover, 50µm	140x190 cm	1	PP/PE

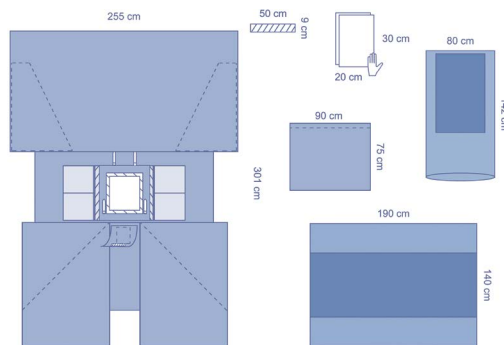

### TB27050CE – Laparoscopy pack

4 ea/cs

Component	Description	Size	Comp qty.	Material
7471	Absorbent hand towel	30x20 cm	1	Cellulose
8339	Mayo stand cover	80x142 cm	1	PP/PE
ZHE750	OP-tape	9x50 cm	3	Spunlace
8483	Under-buttock drape	96x126 cm	1	PP/PE
TB29496	Laparoscopic drape, adhesive fenestrations 34x38cm/11x14cm, incise film	255x301 cm	1	Trilaminare
BTCM15	Back table cover, 50µm	140x190 cm	1	PP/PE

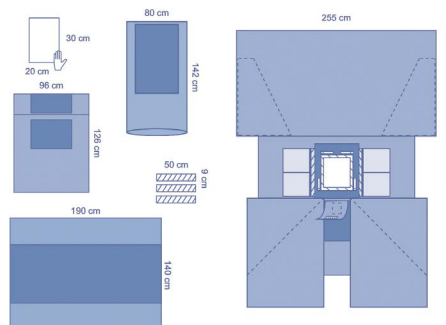

### TB27052CEA – Laparoscopy pack

4 ea/cs

Component	Description	Size	Comp qty.	Material
ES02C212	Side drape	75x75 cm	1	Bilaminate
8483	Under-buttock drape	96x126 cm	1	PP/PE
ZHE750	OP-tape	9x50 cm	1	Spunlace
BTCM16	Back table cover, 50µm	140x190 cm	1	PP/PE
TB29496	Laparoscopic drape, adhesive fenestrations 34x38cm/11x14cm, incise film	255x301 cm	1	Trilaminare
BTCM15	Back table cover, 50µm	140x190 cm	1	PP/PE
1025B	Wrap		1	SMS

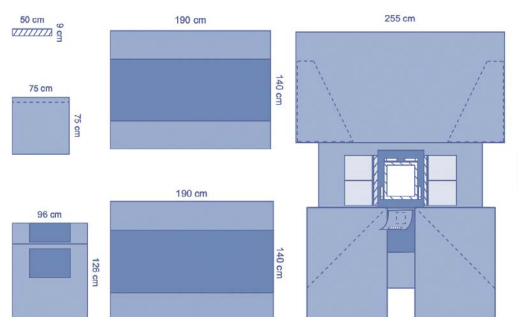

## CP29047CEA – Laparoscopy pack

4 ea/cs

Component	Description	Size	Comp qty.	Material
8339	Mayo stand cover	80x142 cm	1	PP/PE
8520	Absorbent hand towel	58x39 cm	4	Cellulose
VC594	Camera cover	13x240 cm	1	Clear PE
IDE1018L	Instrument pouch	25x46 cm	1	Matte PE
7014WP	Hook and loop tube holder	2,5x14 cm	1	Polyester
TB29496	Laparoscopic drape, adhesive fenestrations 34x38cm/11x14cm, incise film	255x301 cm	1	Trilaminare
BTCXL35	Back table cover, 90µm	203x240 cm	1	PP/PE
1025B	Wrap		1	SMS

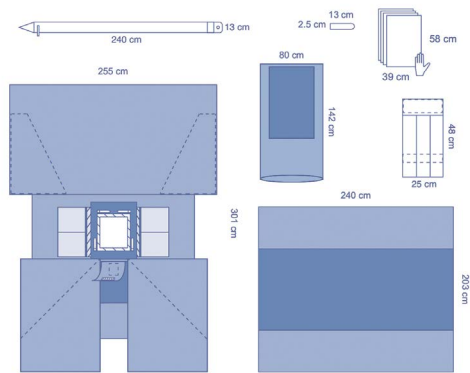

## DYJPEREPSM – Rectum pack

6 ea/cs

Component	Description	Size	Comp qty.	Material
8339	Mayo stand cover	80x142 cm	1	PP/PE
REDSM	Rectum drape, adhesive fenestrations 29x29cm/16x7cm	250/258x337 cm	1	SMS
TC060	Back table cover, 50µm	152x190 cm	1	PP/PE

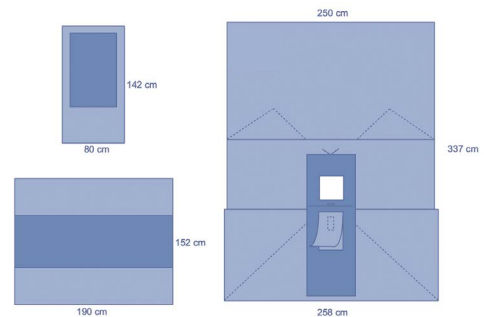

## TB29474CE – Robotic assisted hysterectomy drape

5 ea/cs

Component	Description	Size	Comp qty.	Material
TB29474	LAVH drape, adhesive fenestrations 18x23x23cm and 15x8cm	254/284x277 cm	1	Trilaminare
1025B	Wrap		1	SMS

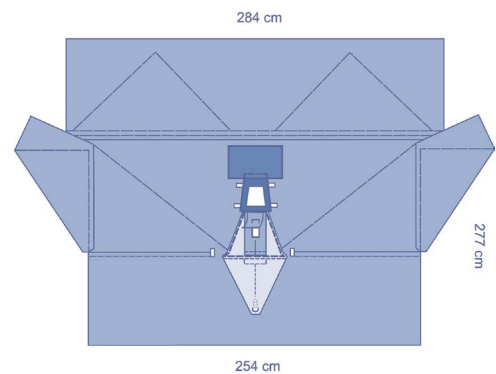

**ES29063CE – Robotic assisted laparoscopy pack** 6 ea/cs

Component	Description	Size	Comp qty.	Material
ES29476	Laparoscopy drape, adhesive fenestrations 30x34cm/15x18cm, incise film, fluide collection pouch	280/310x301 cm	1	Bilaminate
8530	Absorbent hand towel	39x30 cm	2	Cellulose
VC694	Camera cover	15x240 cm	1	Clear PE
ES02C221	Drape sheet	90x75 cm	1	Bilaminate
BTCM15	Back table cover, 50µm	140x190 cm	1	PP/PE

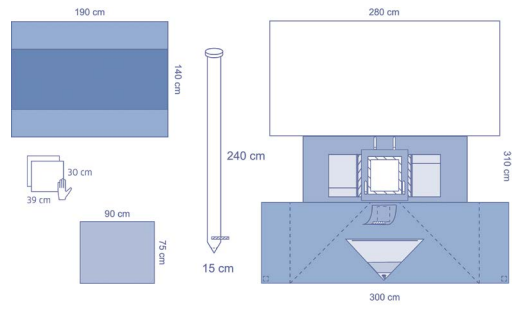

Scan the QR code to watch our draping instructions videos





# General fenestrated packs

## TB30248CE – Minor procedure pack

30 ea/cs

Component	Description	Size	Comp qty.	Material
TB30669	Aperture drape, fenestration 10 cm	98x150 cm	1	Trilaminare
BTCM15	Back table cover, 50µm	140x190 cm	1	PP/PE
1025B	Wrap		1	SMS

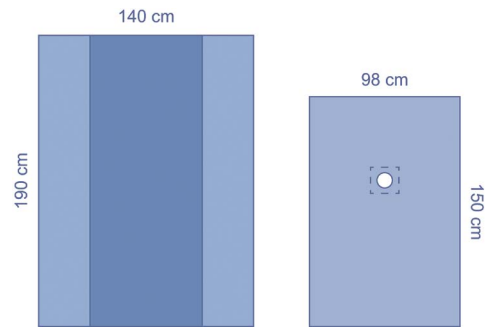

## ES30249CE – Minor procedure pack

36 ea/cs

Component	Description	Size	Comp qty.	Material
ES30769	Aperture drape, adhesive fenestration 12 cm	100x150 cm	1	Bilaminare
BTCM15	Back table cover, 50µm	140x190 cm	1	PP/PE
1025B	Wrap		1	SMS

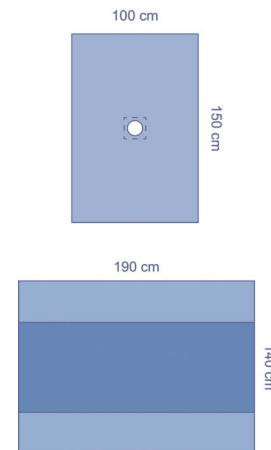

## ES10912CEC – Minor procedure pack

16 ea/cs

Component	Description	Size	Comp qty.	Material
7471	Absorbent hand towel	30x20 cm	2	Cellulose
ES10455	Aperture drape, adhesive fenestration 8x10 cm	157.5x200 cm	1	Bilaminare
BTCM15	Back table cover, 50µm	140x190 cm	1	PP/PE
1025B	Wrap		1	SMS

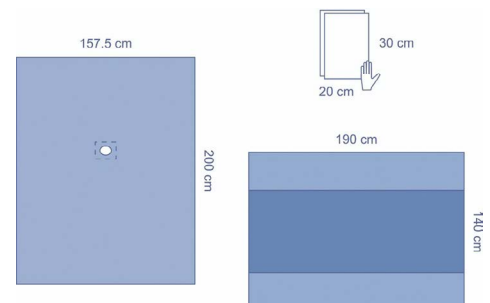

**ES10913CE – Minor procedure pack**

20 ea/cs

Component	Description	Size	Comp qty.	Material
7471	Absorbent hand towel	30x20 cm	2	Cellulose
ES10457	Aperture drape, adhesive fenestration 13x17 cm	150x175 cm	1	Bilaminate
BTCM15	Back table cover, 50µm	140x190 cm	1	PP/PE
1025B	Wrap		1	SMS

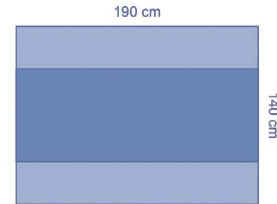
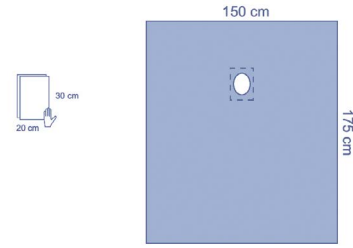

**29232CEA – Fenestrated drape pack**

16 ea/cs

Component	Description	Size	Comp qty.	Material
7471	Absorbent hand towel	30x20 cm	2	Cellulose
16556	Velcro	13x2.5 cm	1	Polyester
29670	Aperture drape, reinforced, adhesive fenestration 6 cm diameter	150x196 cm	1	Spunlace
BTCM15	Back table cover, 50µm	140x190 cm	1	PP/PE
C1030	Wrap		1	Cellulose

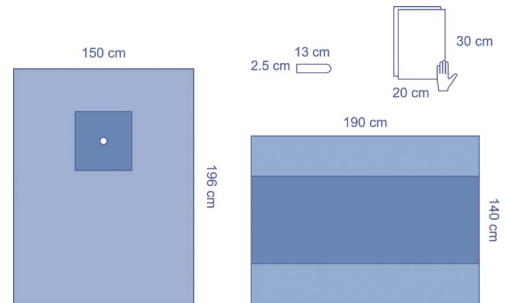

**ES10113CEA – Minor procedure pack**

16 ea/cs

Component	Description	Size	Comp qty.	Material
7471	Absorbent hand towel	30x20 cm	1	Cellulose
ES10456	Aperture drape, adhesive fenestration 14x7 cm diameter	240x200 cm	1	Bilaminate
BTCM15	Back table cover, 50µm	140x190 cm	1	PP/PE
1025B	Wrap		1	SMS

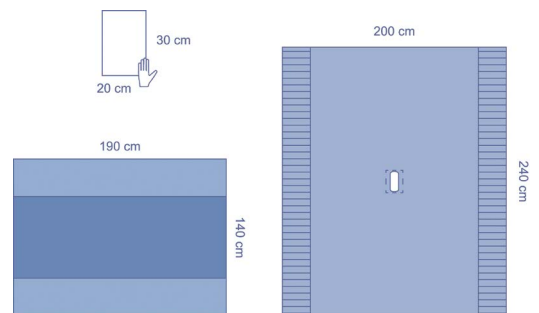

### ES30013CE – Minor procedure pack

14 ea/cs

Component	Description	Size	Comp qty.	Material
7471	Absorbent hand towel	30x20 cm	2	Cellulose
ZHE750	OP-tape	9x50 cm	1	Spunlace
ES10459	Aperture drape, adhesive fenestration 12 cm	220x240 cm	1	Bilaminate
BTCM15	Back table cover, 50µm	140x190 cm	1	PP/PE
1025B	Wrap		1	SMS

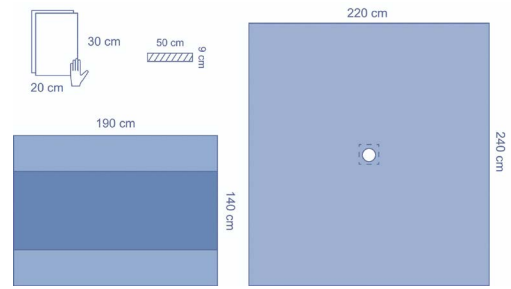

### TB30013CE – Minor procedure pack

12 ea/cs

Component	Description	Size	Comp qty.	Material
7471	Absorbent hand towel	30x20 cm	2	Cellulose
04A035	OP-tape	8x40 cm	1	PE
TB30456	Aperture drape, adhesive fenestration 12 cm	220x240 cm	1	Trilaminare
BTCM15	Back table cover, 50µm	140x190 cm	1	PP/PE
1025B	Wrap		1	SMS

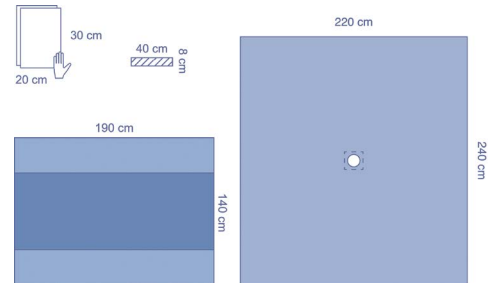

### TB30C172CE – Minor procedure pack

12 ea/cs

Component	Description	Size	Comp qty.	Material
7471	Absorbent hand towel	30x20 cm	1	Cellulose
04A035	OP-tape	8x40 cm	1	PE
TB30455	Aperture drape, adhesive fenestration 12 cm	221x240 cm	1	Trilaminare
BTCM15	Back table cover, 50µm	140x190 cm	1	PP/PE

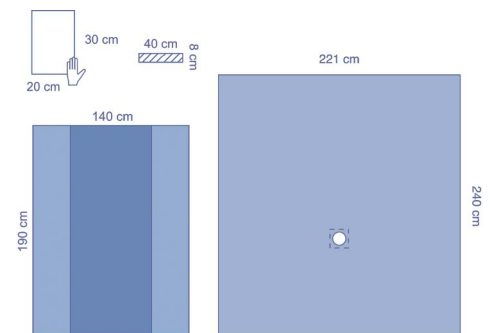

**ES10462CE – Minor procedure pack**

16 ea/cs

Component	Description	Size	Comp qty.	Material
7471	Absorbent hand towel	30x20 cm	1	Cellulose
ZHE750	OP-tape	9x50 cm	1	Spunlace
ES10462	Aperture drape, adhesive fenestration 14,5 cm diameter	200x240 cm	1	Bilaminare
BTM15	Back table cover, 50µm	140x190 cm	1	PP/PE
1025B	Wrap		1	SMS

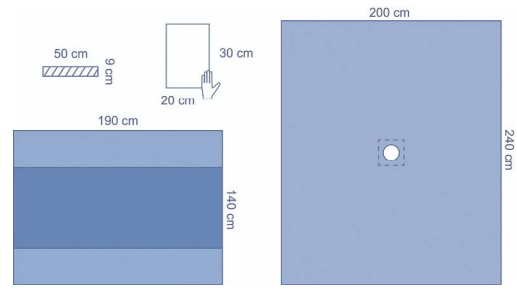

**TB30198CE – Minor procedure pack**

12 ea/cs

Component	Description	Size	Comp qty.	Material
BTCS26	Back table cover, 75µm, folded	140x120 cm	1	PP/PE
01C0203	Drape sheet	47x49 cm	1	Polyrayon
TB30660	Aperture drape, adhesive fenestration 15x15 cm	240x196 cm	1	Trilaminare
BTCS15	Back table cover, 50µm	120x140 cm	1	PP/PE

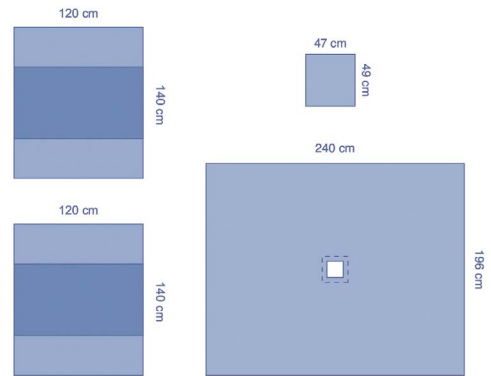



# Wound ring protectors

## Description

- Strong, drapeable, low-glare matte-finish film
- 5 ring diameters to meet different surgical needs
- Application with adhesive tape

## Use

General, laparotomy, cardiothoracic, colectomy

Component	Dimensions	Packaging
IDE3707	90 x 90 cm, ring diameter: 7 cm	40 ea/cs
IDE3712	90 x 90 cm, ring diameter: 12 cm	40 ea/cs
IDE3718	90 x 90 cm, ring diameter: 18 cm	40 ea/cs
IDE3723	90 x 90 cm, ring diameter: 23 cm	40 ea/cs
IDE3728	90 x 90 cm, ring diameter: 28 cm	40 ea/cs

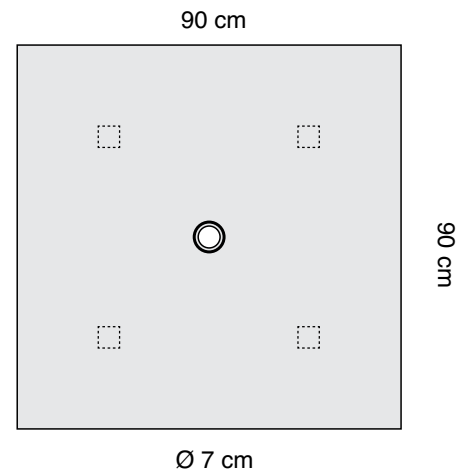

The wound ring protectors have a flexible but rigid ring at the fenestration site to help keep the drape in the correct position. The frosted clear plastic drape around the fenestration helps maintain the sterile barrier.

# Universal drapes

## OPS™ Essential drape sheets

Item order	Component	Size	Case qty.	Material
ES15225CE	ES02C225	45x50 cm	400	Bilaminate
ES15226CE	ES02C226	45x75cm	320	Bilaminate
ES15222CE	ES02C222	75x75 cm	160	Bilaminate
ES15221CE	ES02C221	90x75 cm	160	Bilaminate
ES15235CE	ES02C235	100x100 cm	60	Bilaminate
ES15223CE	ES02C223	90x150 cm	56	Bilaminate
ES15236CE	ES02C236	100x120 cm	51	Bilaminate

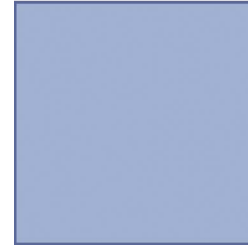

## OPS™ Essential large drape sheets\*

Item order	Component	Size	Case qty.	Material
ES93585CE	ES93585	145x112 cm	25	Bilaminate
ES9355CE	ES9355	180x112 cm	48	Bilaminate
ES9349CE	ES9349	193x145 cm	24	Bilaminate
ES9446CE	ES9446	216x183cm	26	Bilaminate
ES9444CE	ES9444	249x196 cm	18	Bilaminate
ES933CE	ES8023	300x221 cm	24	Bilaminate



## OPS™ Utimate large drape sheets\*

Item order	Component	Size	Case qty.	Material
TB9461CE	TB9461	98x98 cm	68	Trilaminate
TB9358CE	TB9358	145x112 cm	20	Trilaminate
TB9349CEB	TB9349	193x145 cm	16	Trilaminate
TB9446CE	TB9446	216x183 cm	18	Trilaminate
TB9446CE	TB9446	216x183 cm	18	Trilaminate
TB9444CE	TB9444	249x196 cm	16	Trilaminate



\*Delivered in wrap

## OPS™ Essential adhesive drapes

Item order	Component	Adhesive length	Size	Case qty.	Material
ES15215CE	ES02C215	45 cm	45x50 cm	400	Bilaminate
ES15212CE	ES02C212	75 cm	75x75 cm	160	Bilaminate
ES14212CE	ES14212	73 cm, narrow	75x75 cm	160	Bilaminate
ES15211CE	ES02C211	90 cm	90x75 cm	160	Bilaminate
ES15210CE	ES02C210	98 cm	98x75 cm	60	Bilaminate
ES15216CE	ES02C216	100 cm	100x100 cm	45	Bilaminate
ES15213CE	ES02C213	150 cm	150x90 cm	54	Bilaminate

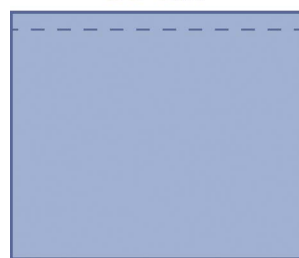

## OPS™ Essential universal drapes\*

Item order	Component	Adhesive length	Size	Case qty.	Material
ES10429CE	ES10429	110 cm	110x90 cm	100	Bilaminate
ES30057CE	ES30057	150 cm	196X150 cm	36	Bilaminate
ES30056CE	ES30056	98 cm	196X150 cm	48	Bilaminate
ES11602CE	ES11602	98 cm	190x200 cm	36	Bilaminate
ES10483CE	ES10483	85 cm	260x160 cm	34	Bilaminate



## OPS™ Ultimate universal drapes\*

Item order	Component	Adhesive length	Size	Case qty.	Material
TB30065CE	TB30053	75 cm	75x91,5 cm	36	Trilaminate
TB31300CE	TB31300	95 cm	98X75 cm	70	Trilaminate
TB9471CE	TB9471	98 cm	98x98 cm	68	Trilaminate
TB30056CEA	TB30056	98 cm	196X150 CM	24	Trilaminate
TB31600CE	TB31600	96 cm	196x200 cm	26	Trilaminate
TB31900CE	TB31900	95 cm	260x160 cm	26	Trilaminate
TB933CEA	TB8023	130 cm	300x221 cm	16	Trilaminate



\*Delivered in wrap

### Clear adhesive drapes

Item order	Component	Adhesive length	Size	Case qty.	Material
IDE1010	IDE1010	46 cm	46x30 cm	40	Clear PE
IDE1000	IDE1000	46 cm	46x61 cm	40	Clear PE



### Adhesive drape packs\*

Item order	Component	Component qty.	Adhesive length	Size	Case qty.	Material
ES307554CE	ES307554	2	59 cm	65x49 cm	108	Bilaminate
TB307554CE	TB307554	2	65 cm	65x49 cm	108	Trilaminate
TB31301CE	TB31300	2	95 cm	75x98 cm	36	Trilaminate

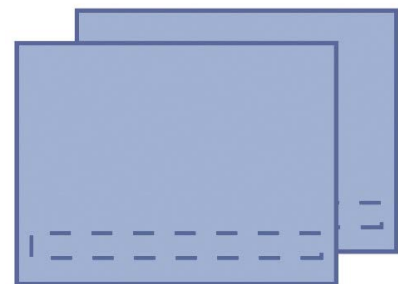

### OPS™ Essential adhesive reinforced drapes\*

Item order	Component	Adhesive length	Size	Case qty.	Material
ES29443CE	ES29443	84 cm	90x75 cm	120	Bilaminate
ES29444CE	ES29444	104 cm	110x95 cm	90	Bilaminate
ES29470CE	ES29470	98 cm	175x190 cm	42	Bilaminate
ES29471CE	ES29471	97 cm	200x200 cm	36	Bilaminate
ES29483CE	ES29483	98 cm	240x150 cm	38	Bilaminate
ES29482CE	ES29482	140 cm	300x170 cm	26	Bilaminate
ES29933CE	ES29933	300 cm	300x183 cm	22	Bilaminate

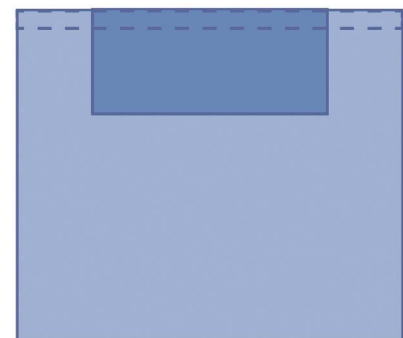

\*Delivered in wrap

## OPS™ Ultimate adhesive reinforced drapes\*

Item order	Component	Adhesive length	Size	Case qty.	Material
TB29439CEA	TB29428	104 cm	98x112 cm	36	Trilaminate
TB29469CE	TB29469	63 cm	191x183 cm	20	Trilaminate
TB29479CE	TB29478	107 cm	254x183 cm	15	Trilaminate

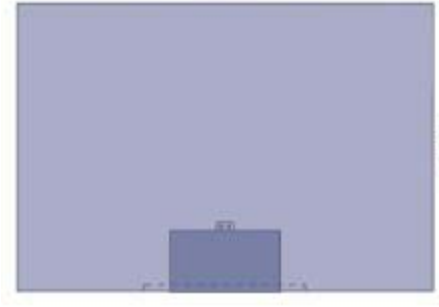

## OPS™ Ultimate reinforced drape with incise film\*

Item order	Component	Adhesive length	Size	Case qty.	Material
TB294431CE	TB294431	84 cm	90x75 cm	59	Trilaminate

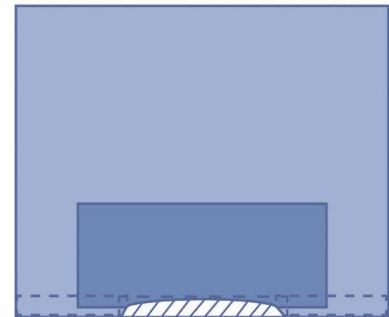

## OPS™ Advanced adhesive reinforced drapes

Item order	Component	Adhesive length	Size	Case qty.	Material
DYJPEFTDSM1	FTDSM1	90 cm	183x175 cm	10	SMS
DYJPEHEDSM2	HEDSM2	78 cm	250x152 cm	8	SMS

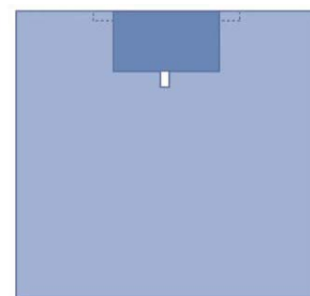

\*Delivered in wrap



### Clear adhesive reinforced drape\*

Item order	Component	Adhesive length	Size	Case qty.	Material
5810CE	5810	240 cm	300x150 cm	17	Clear PE

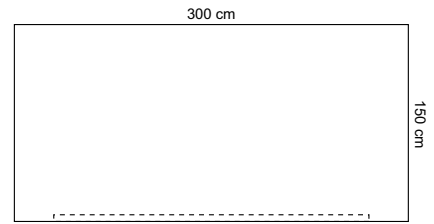

### Ultra-absorbent adhesive drapes\*

Item order	Component	Adhesive length	Size	Case qty.	Material
ABS5035CE	ABS5035	50 cm	50x35cm	88	PP
48150CE	48150	50 cm	50x37 cm	200	Viscose/ cellulose/PE
48151CE	48151	98 cm	100x75 cm	64	Viscose/ cellulose/PE
DYJPESD121	SD121	102 cm	102x102 cm	20	PET/viscose/ PE

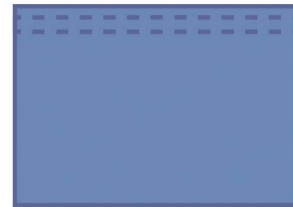

### OPS™ Ultimate reinforced adhesive drape pack\*

Item order	Component	Adhesive length	Size	Case qty.	Material
TB29400CE	2x TB29428	104 cm	112x98 cm	24	Trilaminare

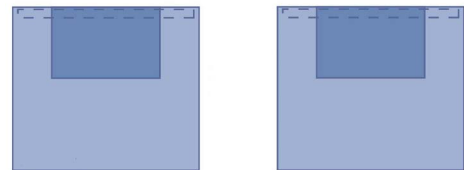

\*Delivered in wrap

# Aperture drapes

## Aperture drapes

Item order	Component	Fenestration size	Size	Case qty.	Material
ES15227CE	ES02C227	5 cm	60x50 cm	320	Bilaminate
S951CE	S951	12cm	65x53 cm	200	SMS
ES15230CE	ES02C230	7 cm	75x45 cm	180	Bilaminate
ES152275CE	ES02CFDS3	8 cm	90x75cm	90	Bilaminate
ES15209CE	ES02C209	10 cm	90x75 cm	180	Bilaminate

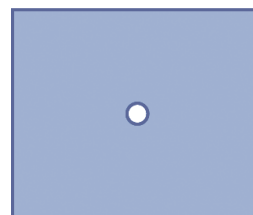

## Reinforced aperture drapes

Item order	Component	Fenestration size	Size	Case qty.	Material
ES9462CE	ES9462	15x10 cm	152x112 cm	32	Bilaminate
TB9462CE	TB9462	15x10 cm	152x112 cm	32	Trilaminate

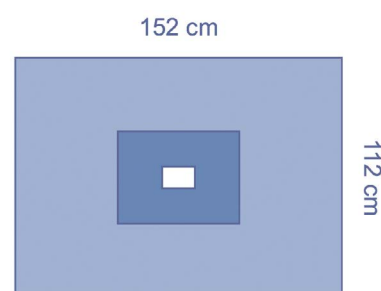

## Adhesive aperture drapes

Item order	Component	Fenestration size	Size	Case qty.	Material
ES15217CE	ES02C217	5 cm	50x60cm	320	Bilaminate
ES15231CE	ES02C231	7 cm	45x75 cm	150	Bilaminate
ES15207CEA	ES02C207	10 cm	75x90cm	180	Bilaminate
TB9777CE	TB9777	10 cm, narrow	76x56 cm	80	Trilaminate
ES10459CE	ES10459	12 cm	220x240 cm	24	Bilaminate
TB30456CE	TB30456	12 cm	220x240 cm	18	Trilaminate

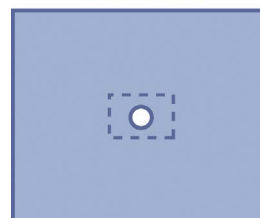

## Adhesive aperture drapes

Item order	Component	Fenestration size	Size	Case qty.	Material
ES15228CE	ES02C228	6x8 cm	75x90 cm	80	Bilaminate
ES15219CE	ES02C319	9x12 cm	100x100 cm	45	Bilaminate
ES15218CE	ES02C218	5x8 cm	120x150 cm	30	Bilaminate
ES152184CE	ES02C2184	8 cm	120x150 cm	60	Bilaminate
ES152183CE	ES02C2183	6x8 cm	120x150 cm	60	Bilaminate

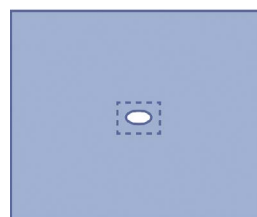

### Clear adhesive aperture drape

Item order	Component	Fenestration size	Size	Case qty.	Material
IDE1020		6 cm	41x41 cm	40	Clear PE

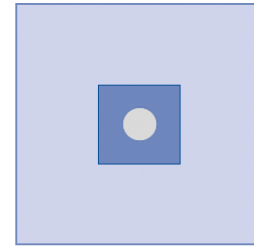

### Adhesive aperture drape packs\*

Item order	Component	Component qty.	Adhesive length	Size	Case qty.	Material
ES15312CE	ES02C221	1	9x12 cm	75x90cm	50	Bilaminate
ES15312CE	ES02C312	1	9x12 cm	75x90 cm	50	Bilaminate

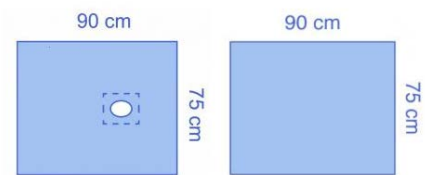

### Adhesive aperture drapes

Item order	Component	Fenestration size	Size	Case qty.	Material
ES152182CE	ES02C2182	10x7 cm	120x150 cm	60	Bilaminate
S8441CE	S8441	5x8 cm	113x158 cm	60	SMS

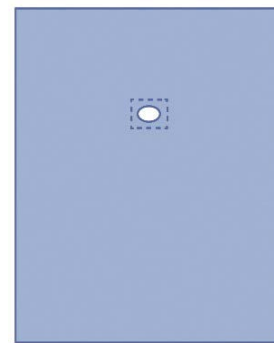

\*Delivered in wrap

### Adhesive aperture drapes

Item order	Component	Fenestration size	Size	Case qty.	Material
TB30669CEA	TB30669	10 cm	98x150 cm	42	Trilaminate
TB30665CE	F8015	12 cm	158x220cm	22	Trilaminate
ES30454CE	ES10454	11 cm	175x250 cm	32	Bilaminate
ES30458CE	ES30458	7 cm	200x240cm	24	Bilaminate
ES10453CE	ES10453	12 cm	220x240 cm	24	Bilaminate

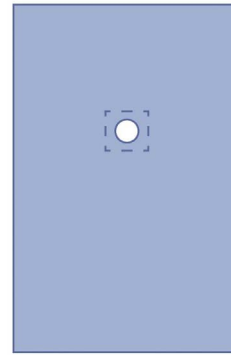

### Clear adhesive aperture drape

Item order	Component	Fenestration size	Size	Case qty.	Material
IDE1030	IDE1030	5X7 cm	82.5x129.5 cm	40	Clear PE

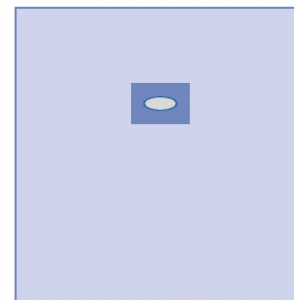

### Reinforced adhesive aperture drapes

Item order	Component	Fenestration size	Size	Case qty.	Material
DYJPEFDSEC	FDSEC	10x15 cm	102x157 cm	20	Spunlace
TB29494CE	TB29494	8x10 cm, narrow	112x152 cm	38	Trilaminate

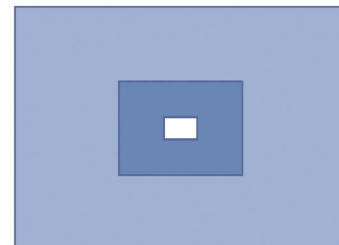

### Arciform drape

Item order	Component	Fenestration size	Size	Case qty.	Material
ES15214CE	ES02C214		45x75 cm	160	Bilaminate

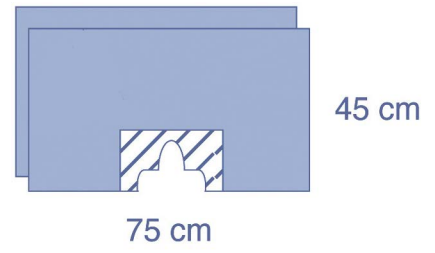

### Absorbent epidural drape

Item order	Component	Fenestration size	Size	Case qty.	Material
ES15003CE	ES15003	8x8 cm	60x80 cm	40	Bilaminate

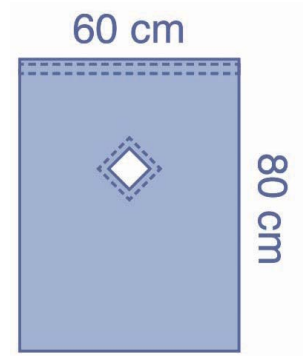

### Clear epidural drape

Item order	Component	Fenestration size	Size	Case qty.	Material
8461CE	8461	9 cm	60X100 cm	150	Spunlace

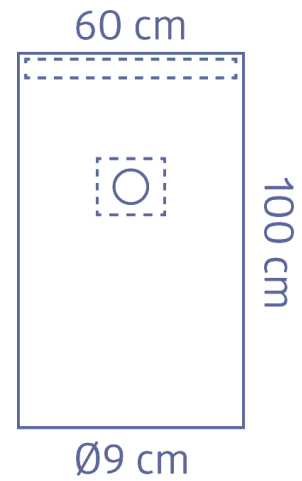



## Clear epidural drape with precut

Item order	Component	Fenestration size	Size	Case qty.	Material
8465CE	8465	6X10 cm	80x140 cm	30	Bilaminate

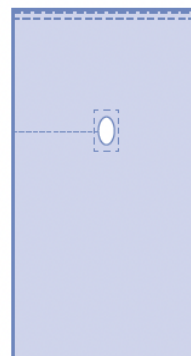

## Epidural drapes

Item order	Component	Fenestration size	Size	Case qty.	Material
ES30009CE	ES3004	8x18 cm	80x120 cm	100	Bilaminate
TB30009CE	TB3004	8x18 cm	80x120 cm	30	Trilaminate

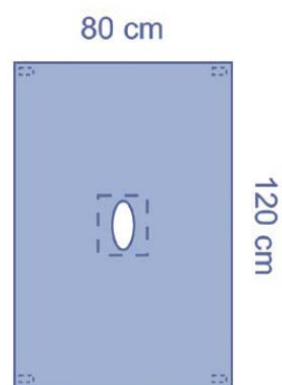

# Arthroscopy drapes and packs

## ES9414CE – Arthroscopy drape

16 ea/cs

Component	Description	Size	Comp qty.	Material
ES9414	Arthroscopy drape, fluid collection pouch	230x300 cm	1	Bilaminate
1025B	Wrap		1	SMS

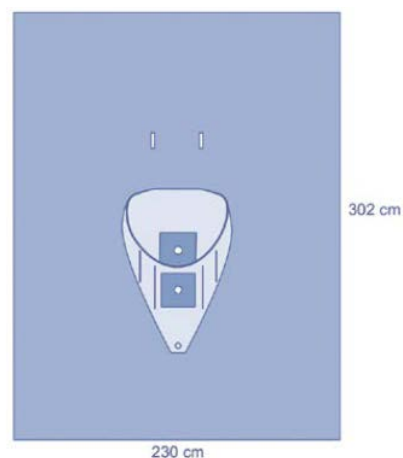

## TB9414CE – Arthroscopy drape

10 ea/cs

Component	Description	Size	Comp qty.	Material
TB9414	Arthroscopy drape, fluid collection pouch	234x302 cm	1	Trilaminare
1025B	Wrap		1	SMS

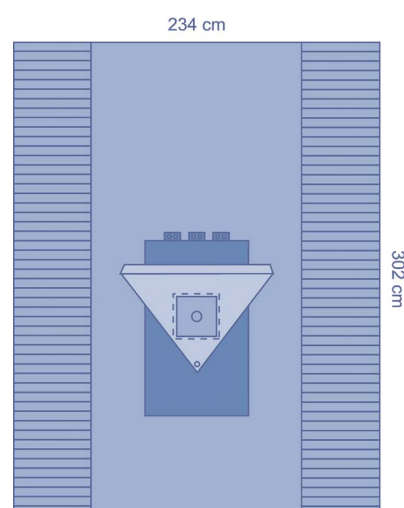

## TB9413CE – Arthroscopy drape

12 ea/cs

Component	Description	Size	Comp qty.	Material
TB9413	Arthroscopy drape, fluid collection pouch	234x302 cm	1	Trilaminare
1025B	Wrap		1	SMS

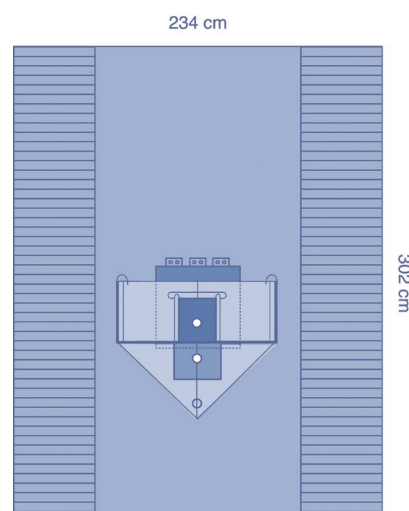

### DYJPEARDTB – Arthroscopy drape

6 ea/cs

Component	Description	Size	Comp qty.	Material
ARDTB	Arthroscopy drape, fluid collection pouch with 2 ports	231/290x315 cm	1	Trilaminare
1025B	Wrap		1	SMS

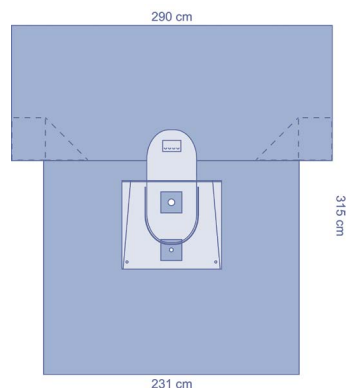

### TB9423CE – Arthroscopy drape

8 ea/cs

Component	Description	Size	Comp qty.	Material
TB9423	Arthroscopy drape, long dimensions, with fluid collection pouch	234/295x447 cm	1	Trilaminare
1025B	Wrap		1	SMS

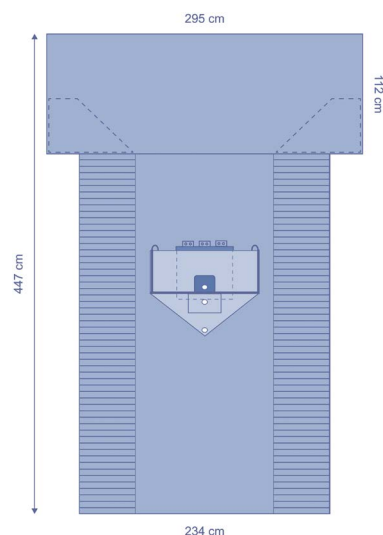

### ES10128CE – Arthroscopy pack

12 ea/cs

Component	Description	Size	Comp qty.	Material
ES9414	Arthroscopy drape, fluid collection pouch	230x300 cm	1	Bilaminare
BTCM15	Back table cover, 50µm	140x190 cm	1	PP/PE
1025B	Wrap		1	SMS

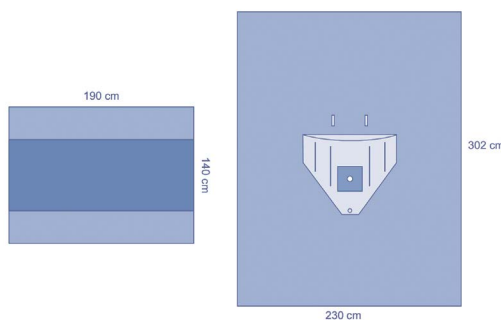

### ES10129CE – Arthroscopy pack

10 ea/cs

Component	Description	Size	Comp qty.	Material
ES9415	Arthroscopy drape, T shaped, with pouch	290/221x322 cm	1	Bilaminare
ES02C224	Drape sheet	150x150 cm	1	Bilaminare
BTCM15	Back table cover, 50µm	140x190 cm	1	PP/PE
1025B	Wrap		1	SMS

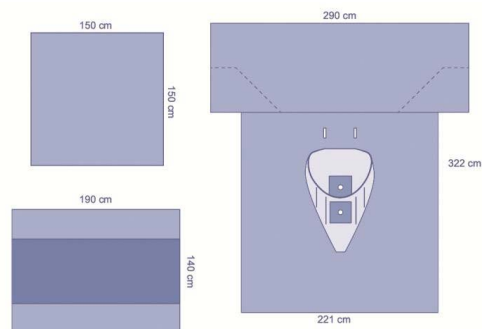

### ES10416CE – Arthroscopy pack

8 ea/cs

Component	Description	Size	Comp qty.	Material
8338	Mayo stand cover	80x142 cm	1	PE
7471	Absorbent hand towel	20x30 cm	2	Cellulose
ZHE750	OP-tape	9x50 cm	2	Spunlace
VC594	Camera cover	13x240 cm	1	PE
ES27009	Stockinette	36.5x72 cm	1	Bilaminare
TC060	Back table cover	152x190 cm	1	PE
ES9415	Arthroscopy drape, T shaped, with pouch	290/221x322 cm	1	Bilaminare
TC060	Back table cover, 50µm	152x190 cm	1	PE

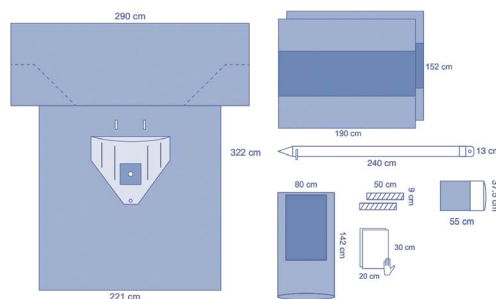

### ES29051CE – Arthroscopy pack

10 ea/cs

Component	Description	Size	Comp qty.	Material
7471	Absorbent hand towel	20x30 cm	2	Cellulose
ZHE750	OP-tape	9x50 cm	2	Spunlace
ES27009	Stockinette	36.5x72 cm	1	Bilaminare
ES02C224	Drape sheet	150x150 cm	1	Bilaminare
ES9414	Arthroscopy drape, fluid collection pouch	230x300 cm	1	Bilaminare
BTCM15	Back table cover, 50µm	140x190 cm	1	PP/PE
1025B	Wrap		1	SMS

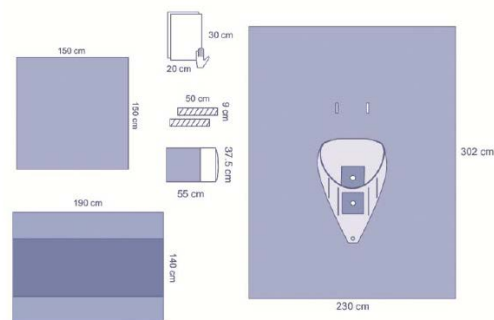

## TB29128CE – Arthroscopy pack

8 ea/cs

Component	Description	Size	Comp qty.	Material
BTCM16	Back table cover, 50µm	140x190 cm	1	PP/PE
7014WP	Hook and loop tube holder	2.5x14 cm	2	Polyester
TB9414	Arthroscopy drape, fluid collection pouch	234x302 cm	1	Trilaminare
BTCM15	Back table cover, 50µm	140x190 cm	1	PP/PE
1025B	Wrap		1	SMS

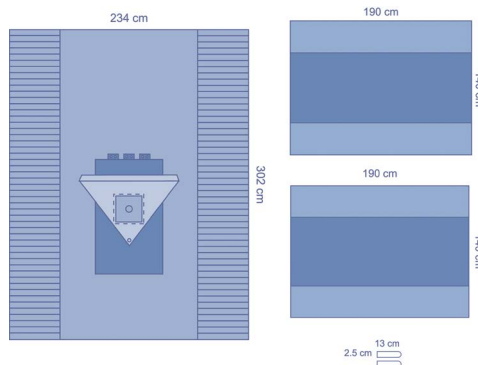

## TB9416CE – Arthroscopy pack

8 ea/cs

Component	Description	Size	Comp qty.	Material
8339	Mayo stand cover	80x142 cm	1	PE
TB9414	Arthroscopy drape, fluid collection pouch	234x302 cm	1	Trilaminare
BTCM15	Back table cover, 50µm	140x190 cm	1	PP/PE

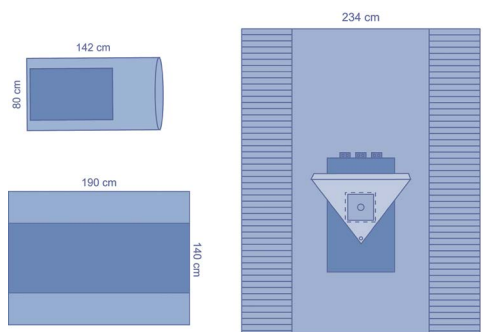

## TB29051CE – Arthroscopy pack

8 ea/cs

Component	Description	Size	Comp qty.	Material
36975E	Stockinette	20x97 cm	1	PP/PE
ZHE750	OP-tape	9x50 cm	2	Spunlace
TB9414	Arthroscopy drape, fluid collection pouch	234x302 cm	1	Trilaminare
BTCM15	Back table cover, 50µm	140x190 cm	1	PP/PE

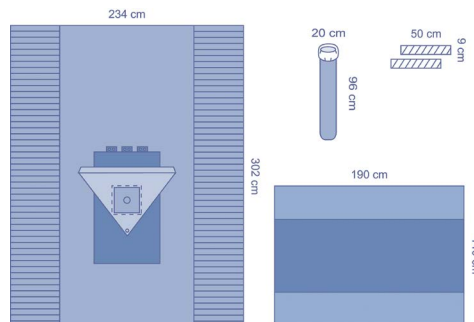



### TB9185CE – Arthroscopy pack

4 ea/cs

Component	Description	Size	Comp qty.	Material
8530	Absorbent hand towel	30x39 cm	4	Cellulose
9506	Eclipse OR gown	L, 120 cm	1	Spunlace
9513	Eclipse OR gown	XL, 150 cm	1	Spunlace
8476	Split drape, U adhesive 15x53 cm	152x183 cm	1	PE
8339	Mayo stand cover	80x142 cm	1	PE
5144	Suture bag	16x31 cm	1	Paper
30460E	Stockinette	23x122 cm	1	PP/PE
ZHE750	OP-tape	9x50 cm	4	Spunlace
TB9414	Arthroscopy drape, fluid collection pouch	234x302 cm	1	Trilaminar
BTCL15	Back table cover, 50µm	125x230 cm	1	PP/PE
1025B	Wrap		1	SMS

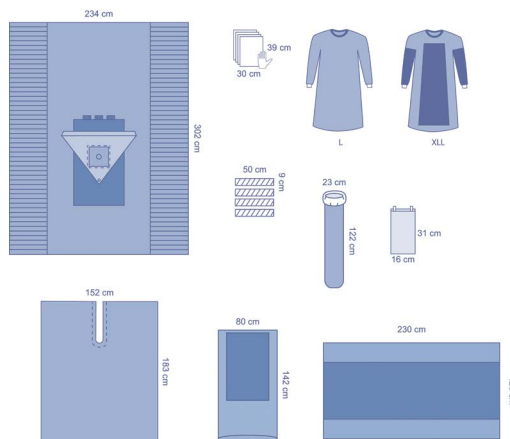

### CP29055CE – Arthroscopy pack

6 ea/cs

Component	Description	Size	Comp qty.	Material
8339	Mayo stand cover	80x142 cm	1	PE
8520	Absorbent hand towel	39x58 cm	4	Cellulose
VC794E	Camera cover	17.5x240 cm	1	Clear PE
ZHE750	OP-tape	9x50 cm	2	Spunlace
TB27009	Stockinette	55x37.5 cm	1	Trilaminar
04A036	Instrument pouch, 2 compartments	33x41 cm	1	Clear PE film
7023W	Hook and loop tube holder	2.5x23 cm	1	
ES11600	Foot drape	175x175 cm	1	Bilaminar
TB9414	Arthroscopy drape, fluid collection pouch	234x302 cm	1	Trilaminar
BTCL15	Back table cover, 50µm	140x190 cm	1	PP/PE
1025B	Wrap		1	SMS

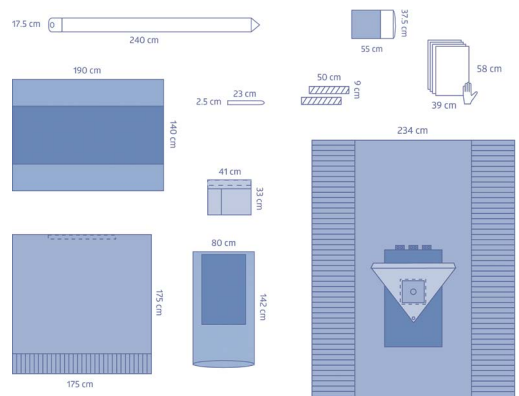

## CPE10016CE – Arthroscopy pack

2 ea/cs

Component	Description	Size	Comp qty.	Material
WS3540P	Essential OR gown, polyreinforced, MD/PPE	140 cm	1	SMS
8520	Absorbent hand towel	39x58 cm	10	Cellulose
S3513P	Essential OR gown, polyreinforced, MD/PPE	140 cm	2	SMS
8340	Mayo stand cover, ultra-reinforced	80x145 cm	1	PE
IDE1018L	Instrument pouch	25x46 cm	1	Matte PE
VC594	Camera cover	13x240 cm	1	
36975E	Stockinette	20x97 cm	1	PP/PE
7023W	Hook and loop tube holder	2.5x23 cm	2	
ZHE750	OP-tape	9x50 cm	2	Spunlace
ES30056	Adhesive drape	150x196 cm	1	Bilaminate
ES9424	Split drape, U adhesive 8,5x107 cm	220x300 cm	1	Bilaminate
ES9415	Arthroscopy drape, T shaped, with pouch	290/221x322 cm	1	Bilaminate
BTCL25	Back table cover, 75µm	160x240 cm	1	PP/PE
1025B	Wrap		1	SMS

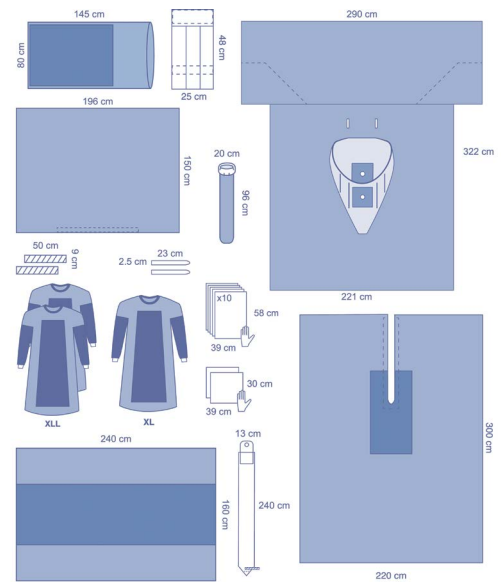

Scan the QR code to watch our draping instructions videos

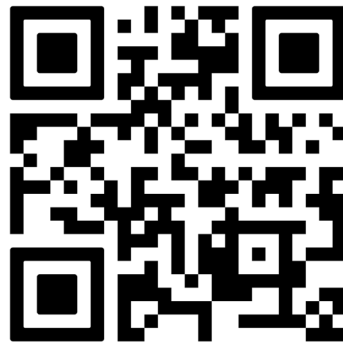

# Extremity drapes and packs

## ES10413CE – Hand and foot minor surgery drape 50 ea/cs

Component	Description	Size	Comp qty.	Material
ES10413	Foot and hand drape	140x170cm	1	Bilaminate
1025B	Wrap		1	SMS

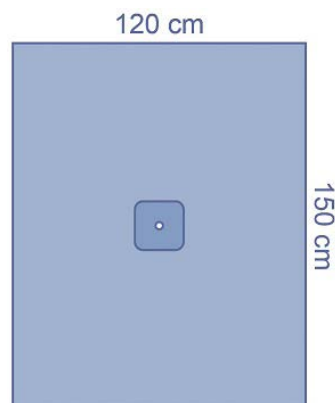

## ES10414CE – Hand and foot drape 18 ea/cs

Component	Description	Size	Comp qty.	Material
ES10414	Extremity drape, elastic fenestration 3.5 cm	230x325 cm	1	Bilaminate
1025B	Wrap		1	SMS

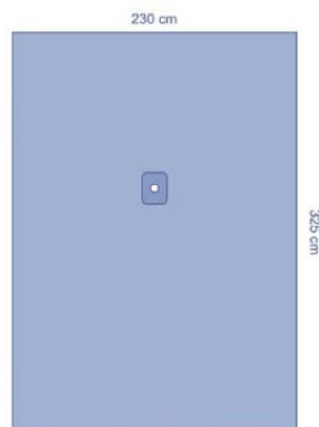

## ES10409CEB – Hand and foot pack 14 ea/cs

Component	Description	Size	Comp qty.	Material
7471	Absorbent hand towel	20x30 cm	2	Cellulose
ZHE750	OP-tape	9x50 cm	1	Spunlace
ES1006	Extremity drape, elastic fenestration 3.5 cm	300 x 230 cm	1	Bilaminate
BTCM15	Back table cover, 50µm	140x190 cm	1	PP/PE
1025B	Wrap		1	SMS

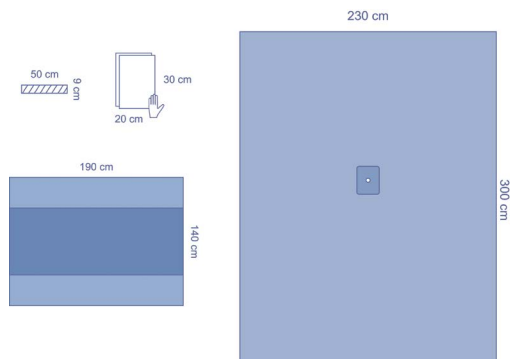

## ES10412CE – Extremity pack

10 ea/cs

Component	Description	Size	Comp qty.	Material
ZHE750	OP-tape	9x50 cm	1	Spunlace
ES02C224	Drape sheet	150x150 cm	1	Bilaminate
ES10066	Extremity drape, elastic fenestration 6 cm	300 x 230 cm	1	Bilaminate
BTCM15	Back table cover, 50µm	140x190 cm	1	PP/PE
1025B	Wrap		1	SMS

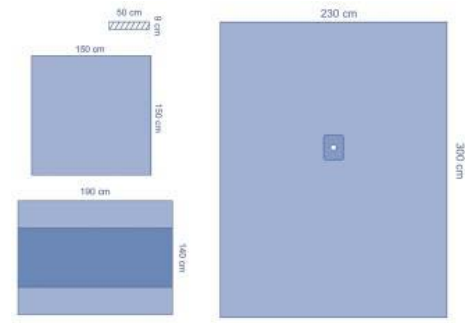

## ES10410CE – Extremity pack

8 ea/cs

Component	Description	Size	Comp qty.	Material
8338	Mayo stand cover	80x142 cm	1	PE </td
7471	Absorbent hand towel	20x30 cm	2	Cellulose
ZHE750	OP-tape	9x50 cm	1	Spunlace
ES02C212	Side drape	75x75 cm	1	Bilaminate
TC060	Back table cover, 50µm	152x190 cm	1	PE </td
ES10065	Extremity drape, elastic fenestration 6 cm	300 x 200 cm	1	Bilaminate
TC060	Back table cover, 50µm	152x190 cm	1	PE

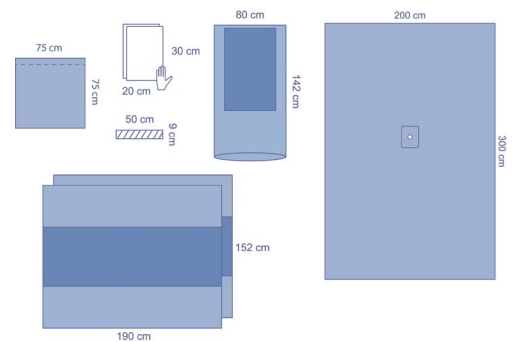

## ES10411CE – Extremity pack

8 ea/cs

Component	Description	Size	Comp qty.	Material
8338	Mayo stand cover	80x142 cm	1	PE
7471	Absorbent hand towel	20x30 cm	2	Cellulose
ZHE750	OP-tape	9x50 cm	1	Spunlace
ES27009	Stockinette	36.5x72 cm	1	Bilaminate
TC060	Back table cover, 50µm	152x190 cm	1	PE
ES10065	Extremity drape, elastic fenestration 6 cm	300 x 200 cm	1	Bilaminate
TC060	Back table cover, 50µm	152x190 cm	1	PE

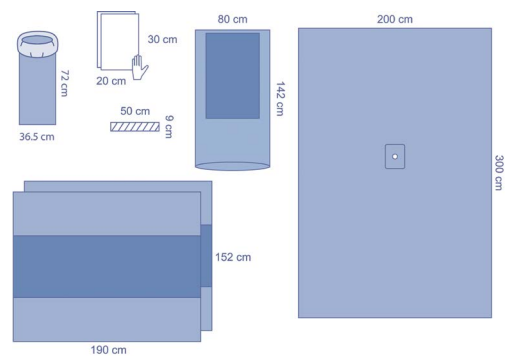

### TB30012CE – Extremity pack

10 ea/cs

Component	Description	Size	Comp qty.	Material
7014WP	Hook and loop tube holder	2.5x14 cm	1	Polyester
TB3006	Extremity drape, elastic fenestration 5 cm	242x300 cm	1	Trilaminare
BTCM15	Back table cover, 50µm	140x190 cm	1	PP/PE
1025B	Wrap		1	SMS

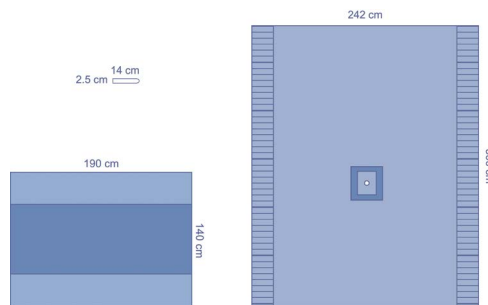

### TB30C012CE – Extremity pack

10 ea/cs

Component	Description	Size	Comp qty.	Material
TB3012	Drape sheet	91x150 cm	1	Trilaminare
TB3006	Extremity drape, elastic fenestration 5 cm	242x300 cm	1	Trilaminare
7014WP	Hook and loop tube holder	2.5x14 cm	1	Polyester
BTCM15	Back table cover, 50µm	140x190 cm	1	PP/PE
1025B	Wrap		1	SMS

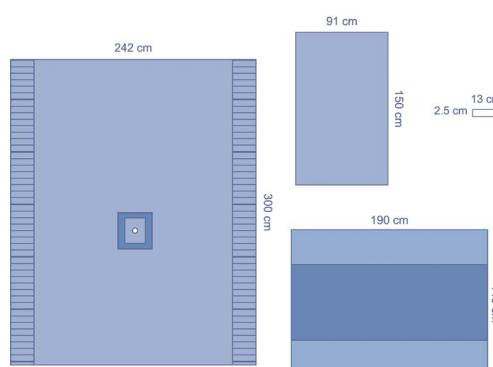

### ES29412CE – Reinforced hand and foot drape

18 ea/cs

Component	Description	Size	Comp qty.	Material
ES29412	Extremity drape, elastic fenestration 3.5 cm	230x345 cm	1	Bilaminare
1025B	Wrap		1	SMS

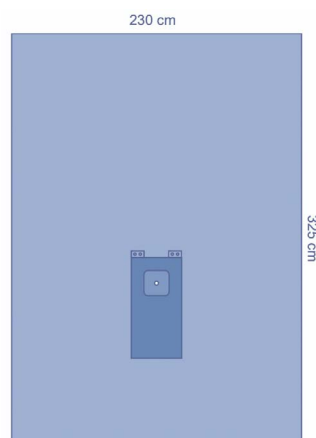



## ES29181CE – Reinforced hand and foot pack

12 ea/cs

Component	Description	Size	Comp qty.	Material
7471	Absorbent hand towel	20x30 cm	4	Cellulose
ES02C224	Drape sheet	150x150 cm	1	Bilaminate
ES29412	Extremity drape, elastic fenestration 3 cm	230x345 cm	1	Bilaminate
BTCM15	Back table cover, 50µm	140x190 cm	1	PP/PE
1025B	Wrap		1	SMS

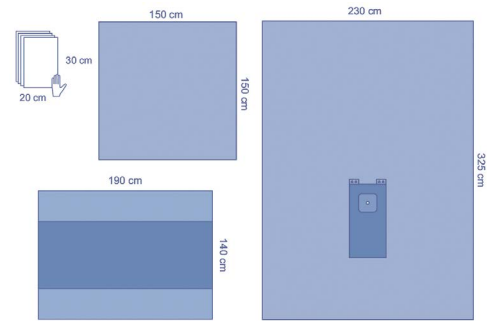

## ES29182CE – Reinforced hand and foot pack

8 ea/cs

Component	Description	Size	Comp qty.	Material
7471	Absorbent hand towel	20x30 cm	4	Cellulose
8339	Mayo stand cover	80x142 cm	1	PE </td
ES29412	Extremity drape, elastic fenestration 3.5 cm	230x345 cm	1	Bilaminate
BTCM15	Back table cover, 50µm	140x190 cm	1	PP/PE
1025B	Wrap		1	SMS

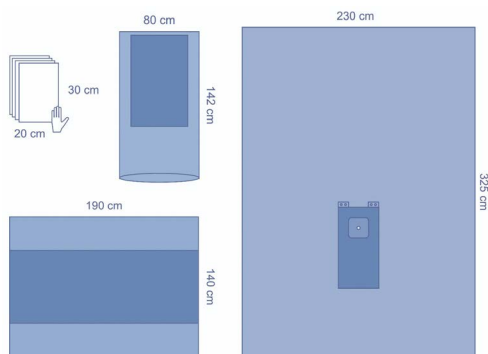

**ES29414CE – Reinforced extremity drapes\***

14 ea/cs

Component	Description	Size	Comp qty.	Material
ES29414	Extremity drape, elastic fenestration 6 cm	230x325 cm	1	Bilaminate

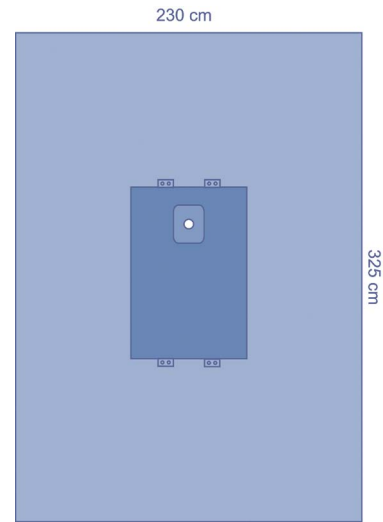

**TB29414CE – Reinforced extremity drapes\***

11 ea/cs

Component	Description	Size	Comp qty.	Material
TB29414	Extremity drape, elastic fenestration 6 cm	230x325 cm	1	Trilaminare

**ES29414CE – Reinforced extremity drapes\***

14 ea/cs

Component	Description	Size	Comp qty.	Material
ES29405	Extremity drape, elastic fenestration 6 cm	221/295x335 cm	1	Bilaminate

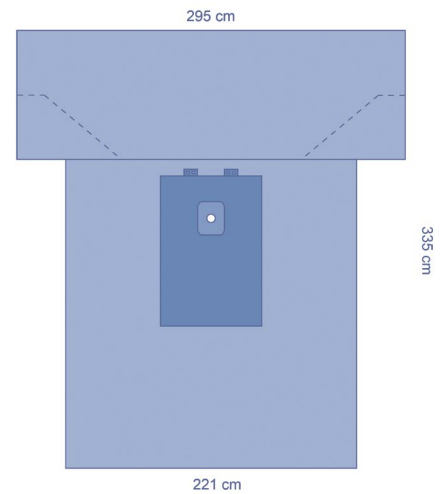

**TB29414CE – Reinforced extremity drapes\***

9 ea/cs

Component	Description	Size	Comp qty.	Material
TB29405	Extremity drape, elastic fenestration 6 cm	221/295x333 cm	1	Trilaminare

\*Delivered in wrap

## ES29185CE – Reinforced extremity pack

12 ea/cs

Component	Description	Size	Comp qty.	Material
7471	Absorbent hand towel	20x30 cm	2	Cellulose
ES29414	Extremity drape, elastic fenestration 6 cm	230x325 cm	1	Bilaminate
BTCM15	Back table cover, 50µm	140x190 cm	1	PP/PE
1025B	Wrap		1	SMS

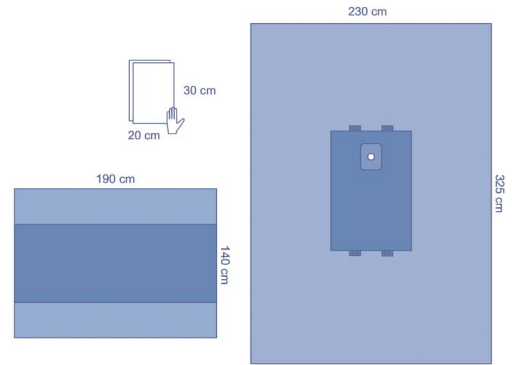

## ES29186CE – Reinforced extremity pack

10 ea/cs

Component	Description	Size	Comp qty.	Material
ES02C224	Drape sheet	150x150 cm	1	Bilaminate
ES29414	Extremity drape, elastic fenestration 6 cm	230x325 cm	1	Bilaminate
BTCM15	Back table cover, 50µm	140x190 cm	1	PP/PE
1025B	Wrap		1	SMS

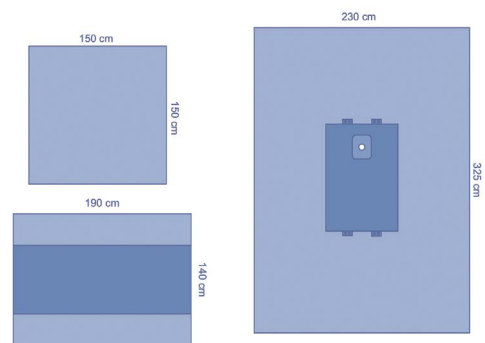

## ES29973CE – Reinforced extremity pack

8 ea/cs

Component	Description	Size	Comp qty.	Material
8338	Mayo stand cover	80x142 cm	1	PP/PE
7471	Absorbent hand towel	20x30 cm	2	Cellulose
ZHE750	OP-tape	9x50 cm	2	Spunlace
ES02C212	Side drape	75x75 cm	1	Bilaminate
ES29414	Extremity drape, elastic fenestration 6 cm	230x325 cm	1	Bilaminate
TC060	Back table cover, 50µm	152x190 cm	2	PE

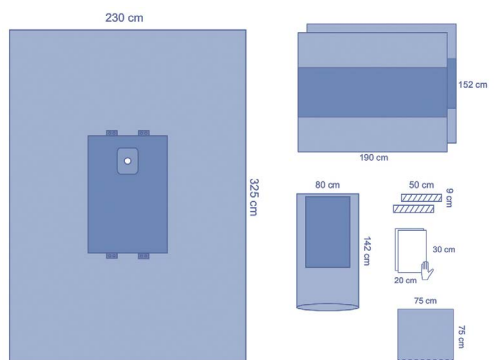

**ES29024CE – Reinforced extremity pack**

8 ea/cs

Component	Description	Size	Comp qty.	Material
ZHE750	OP-tape	9x50 cm	2	Spunlace
ES02C224	Drape sheet	150x150 cm	1	Bilaminate
ES29405	Extremity drape, elastic fenestration 6 cm	221/295x335 cm	1	Bilaminate
BTCM15	Back table cover, 50µm	140x190 cm	1	PP/PE
1025B	Wrap		1	SMS

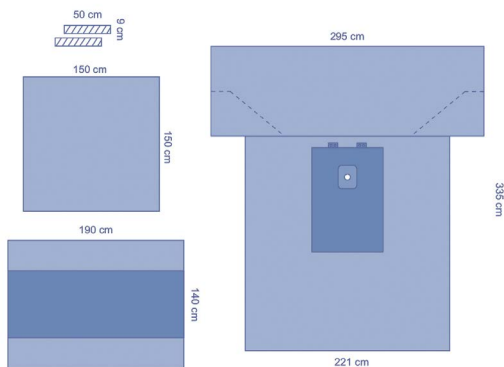

**ES29962CE – Reinforced extremity pack**

6 ea/cs

Component	Description	Size	Comp qty.	Material
8338	Mayo stand cover	80x142 cm	1	PE
7471	Absorbent hand towel	20x30 cm	2	Cellulose
ZHE750	OP-tape	9x50 cm	2	Spunlace
ES27009	Stockinette	36.5x72 cm	1	Bilaminate
TC060	Back table cover, 50µm	152x190 cm	1	PE
ES29405	Extremity drape, elastic fenestration 6 cm	221/295x335 cm	1	Bilaminate
TC060	Back table cover, 50µm	152x190 cm	1	PE

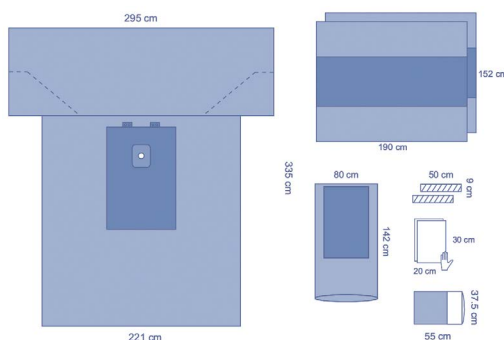

**TB29185CE – Reinforced extremity pack**

8 ea/cs

Component	Description	Size	Comp qty.	Material
TB29414	Extremity drape, elastic fenestration 6 cm	230x325 cm	1	Trilaminate
BTCM15	Back table cover, 50µm	140x190 cm	1	PP/PE
1025B	Wrap		1	SMS

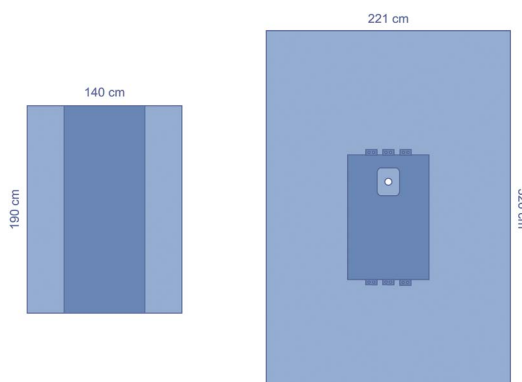

## TB29041CE – Reinforced extremity pack

6 ea/cs

Component	Description	Size	Comp qty.	Material
36975E	Stockinette	20x97 cm	1	PP/PE
04A035	OP-tape	8x40 cm	4	PE
TB29414	Extremity drape, elastic fenestration 6 cm	230x325 cm	1	Trilaminare
BTCL15	Back table cover, 50µm	125x230 cm	1	PP/PE
1025B	Wrap		1	SMS

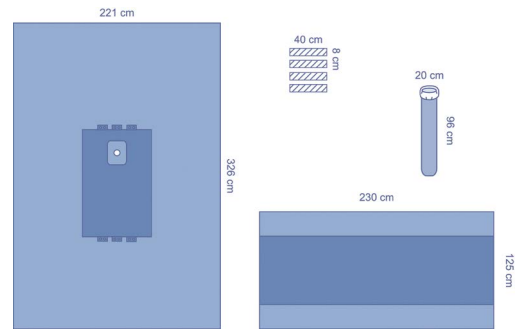

## TB9186CE – Reinforced extremity pack

8 ea/cs

Component	Description	Size	Comp qty.	Material
BTCM16	Back table cover, 50µm	140x190 cm	1	PP/PE
TB29414	Extremity drape, elastic fenestration 6 cm	230x325 cm	1	Trilaminare
BTCM15	Back table cover, 50µm	140x190 cm	1	PP/PE
1025B	Wrap		1	SMS

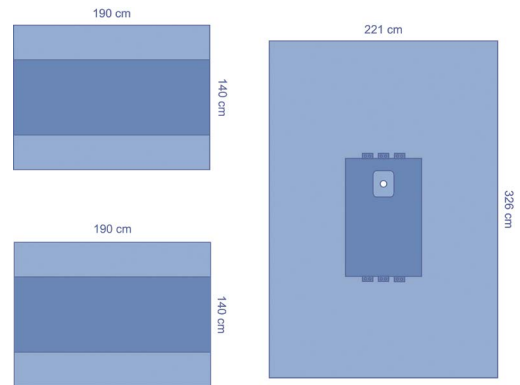

## TB29188CE – Reinforced extremity pack

7 ea/cs

Component	Description	Size	Comp qty.	Material
8520	Absorbent hand towel	39x58 cm	2	Cellulose
29960	Suture bag	25x33 cm	1	PE
BTCM16	Back table cover, 50µm	140x190 cm	1	PP/PE
8339	Mayo stand cover	80x142 cm	1	PE
TB29414	Extremity drape, elastic fenestration 6 cm	230x325 cm	1	Trilaminare
BTCL15	Back table cover, 50µm	125x230 cm	1	PP/PE
1025B	Wrap		1	SMS

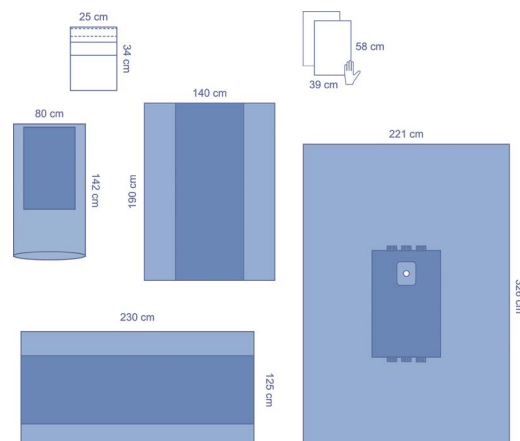

### TB29118CE – Reinforced extremity pack

8 ea/cs

Component	Description	Size	Comp qty.	Material
8339	Mayo stand cover	80x142 cm	1	PE
ES02C211	Adhesive drape	75x90 cm	1	Bilaminate
ZHE750	OP-tape	9x50 cm	1	Spunlace
TB29415	Extremity drape, centred elastic fenestration 6 cm	218x323 cm	1	Trilaminate
BTCM15	Back table cover, 50µm	140x190 cm	1	PP/PE

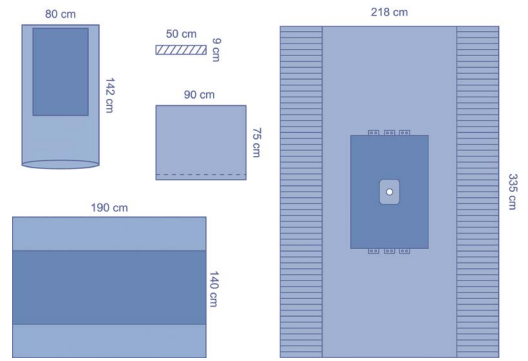

### TB29973CE – Reinforced extremity pack

6 ea/cs

Component	Description	Size	Comp qty.	Material
MAYOM	Mayo stand cover	80x145 cm	1	PP/PE
30460E	Stockinette	23x122 cm	1	PP/PE
TB9349	Utility drape	145x193 cm	1	Trilaminate
ZHE750	OP-tape	9x50 cm	3	Spunlace
TB29414	Extremity drape, elastic fenestration 6 cm	230x325 cm	1	Trilaminate
BTCM15	Back table cover, 50µm	140x190 cm	1	PP/PE

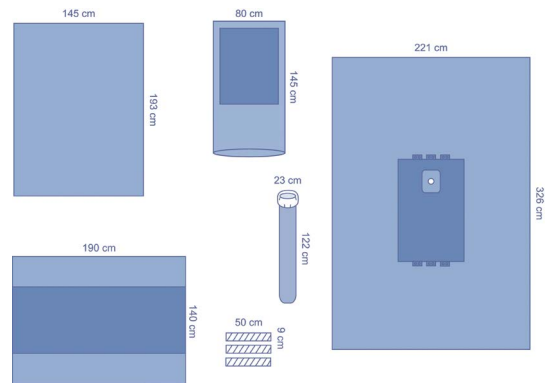

### CP29032CE – Reinforced extremity pack

8 ea/cs

Component	Description	Size	Comp qty.	Material
8340	Mayo stand cover, ultra-reinforced	80x145 cm	1	PE
TB9349	Utility drape	145x193 cm	1	Trilaminate
8530	Absorbent hand towel	30x39 cm	4	Cellulose
TB29415	Extremity drape, centred elastic fenestration 6 cm	218x323 cm	1	Trilaminate
BTCS15	Back table cover, 50µm, folded	120x140 cm	1	PP/PE
BTCM25	Back table cover, 75µm	140x190 cm	1	PP/PE

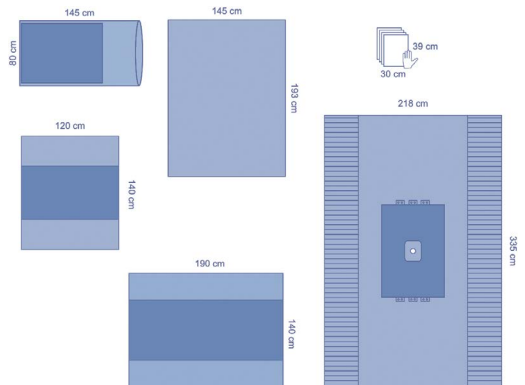



## TB29C024CEA – Reinforced extremity pack

6 ea/cs

Component	Description	Size	Comp qty.	Material
BTCM16	Back table cover, 50µm	140x190 cm	1	PP/PE
O4A035	OP-tape	8x40 cm	2	PE
TB29405	Extremity drape, elastic fenestration 6 cm	221/295x333 cm	1	Trilaminare
BTCM15	Back table cover, 50µm	140x190 cm	1	PP/PE
1025B	Wrap		1	SMS

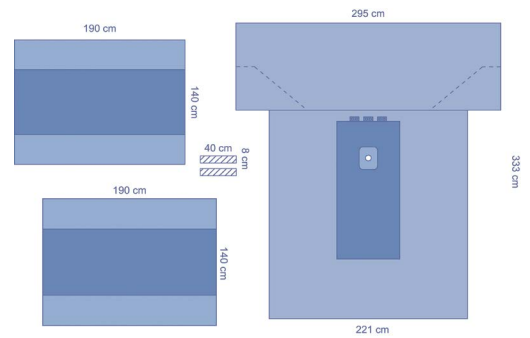

## TB29020CE – Reinforced extremity pack

6 ea/cs

Component	Description	Size	Comp qty.	Material
ES02C223	Drape sheet	90x150 cm	1	Bilaminare
8475	Split drape, U adhesive 20x76 cm	152x213 cm	1	PE
TB29405	Extremity drape, elastic fenestration 6 cm	221/295x333 cm	1	Trilaminare
BTCM15	Back table cover, 50µm	140x190 cm	1	PP/PE
1025B	Wrap		1	SMS
BTCM15	Back table cover, 50µm	140x190 cm	1	PP/PE

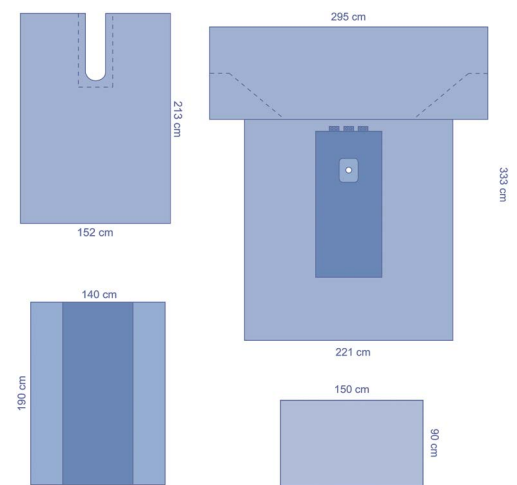

## TB962CE – Reinforced extremity pack

6 ea/cs

Component	Description	Size	Comp qty.	Material
8340C	Mayo stand cover, ultra-reinforced	80x145 cm	1	PP/PE
BTCM16	Back table cover, 50µm	140x190 cm	1	PP/PE
7471	Absorbent hand towel	20x30 cm	2	Cellulose
ZHE750	OP-tape	9x50 cm	1	Spunlace
TB29405	Extremity drape, elastic fenestration 6 cm	221/295x333 cm	1	Trilaminare
BTCM15	Back table cover, 50µm	140x190 cm	1	PP/PE

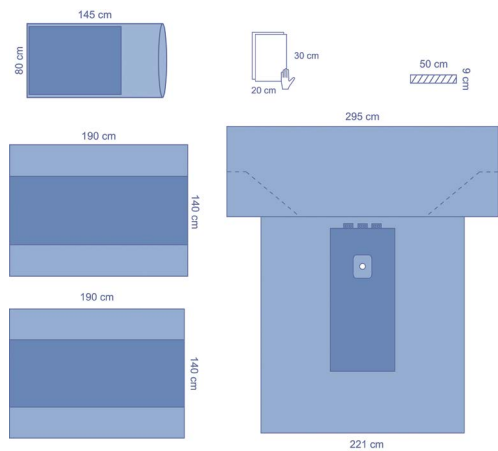

**CPU29017CE – Reinforced extremity pack**

2 ea/cs

Component	Description	Size	Comp qty.	Material
WS3513P	Essential OR gown, polyreinforced, MD/PPE	140 cm	1	SMS
8530	Absorbent hand towel	30x39 cm	2	Cellulose
BTCL36	Back table cover, 90µm, folded	160x240 cm	1	PP/PE
04A036	Instrument pouch, 2 compartments	33x41 cm	1	Clear PE film
ES30056	Adhesive drape	150x196 cm	1	Bilaminare
8530	Absorbent hand towel	30x39 cm	2	Cellulose
S3513P	Essential OR gown, polyreinforced, MD/PPE	140 cm	1	SMS
8340	Mayo stand cover, ultra-reinforced	80x145 cm	1	PE
8530	Absorbent hand towel	30x39 cm	2	Cellulose
S3513P	Essential OR gown, polyreinforced, MD/PPE	140 cm	1	SMS
36975E	Stockinette	20x97 cm	1	PP/PE
04A039	Instrument pouch, 1 compartment	33x41cm	1	PE
7023W	Hook and loop tube holder	2,5x23 cm	2	
ZHE750	OP-tape	9x50 cm	4	Spunlace
ES9424	Split drape, U adhesive 8.5x107 cm	220x300 cm	1	Bilaminare
TB29405	Extremity drape, elastic fenestration 6 cm	221/295x333 cm	1	Trilaminare
BTCL35	Back table cover, 90µm	160x240 cm	1	PP/PE
1025B	Wrap		1	SMS

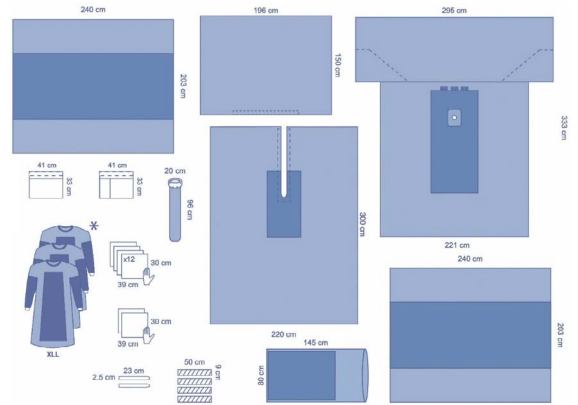

**TB29416WCE – Bilateral extremity pack**

7 ea/cs

Component	Description	Size	Comp qty.	Material
TB29416	Bilateral extremity drape, 2 elastic fenestrations 4 cm	183x305 cm	1	Trilaminare
BTCL15	Back table cover, 50µm	140x190 cm	1	PP/PE
1025B	Wrap		1	SMS

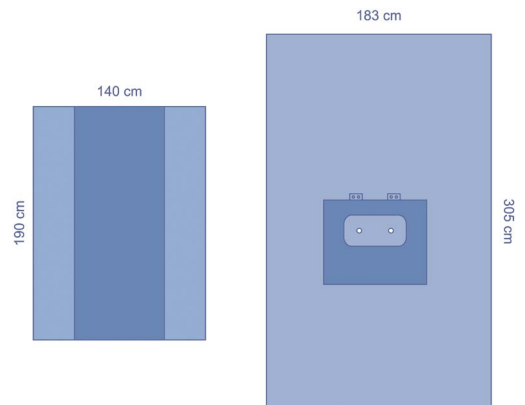

## TB29417WCE – Bilateral extremity pack

8 ea/cs

Component	Description	Size	Comp qty.	Material
TB29417	Bilateral extremity drape, 2 elastic fenestrations 6 cm	273x381 cm	1	Trilaminare
1025B	Wrap		1	SMS
BTCM15	Back table cover, 50µm, folded	140x190 cm	1	PP/PE

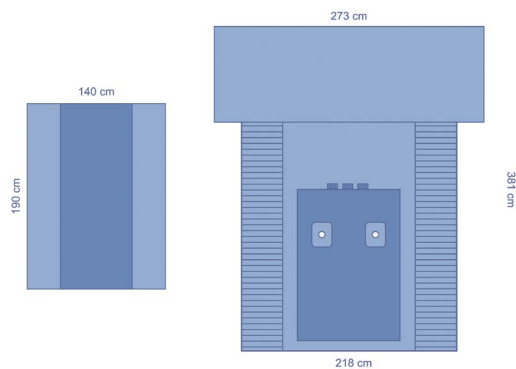

## CP29550CE – Bilateral extremity pack

6 ea/cs

Component	Description	Size	Comp qty.	Material
BTCS16	Back table cover, 50µm	140x120 cm	1	PP/PE
TB29417	Bilateral extremity drape, 2 elastic fenestrations 6 cm	273x381 cm	1	Trilaminare
BTCM15	Back table cover, 50µm	140x190 cm	1	PP/PE
1025B	Wrap		1	SMS

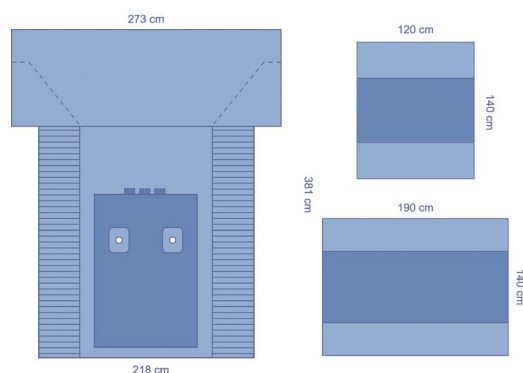

## TB29184CE – Reinforced extremity pack

6 ea/cs

Component	Description	Size	Comp qty.	Material
ES02C223	Drape sheet	90x150 cm	1	Bilaminare
TB29413	Extremity drape, elastic fenestration 3 cm	303x300 cm	1	Trilaminare
BTCM15	Back table cover, 50µm	140x190 cm	1	PP/PE
1025B	Wrap		1	SMS

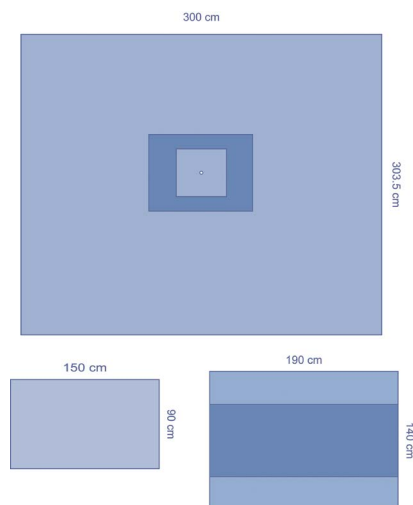

# Hand drapes and packs

## ES29419CE – Hand pack\*

12 ea/cs

Component	Description	Size	Comp qty.	Material
ES29419	Hand drape, with elastic fenestration 3 cm	163/373x196 cm	1	Bilaminare

## TB29419CE – Hand pack\*

9 ea/cs

Component	Description	Size	Comp qty.	Material
TB29419	Hand drape, with elastic fenestration 3 cm	163/373x196 cm	1	Trilaminare

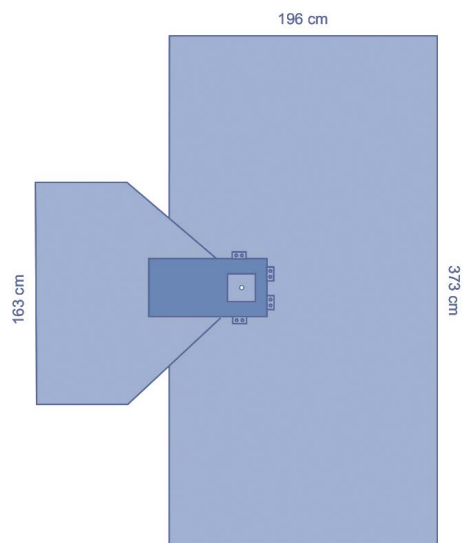

## SM29419CE – Hand drape\*

12 ea/cs

Component	Description	Size	Comp qty.	Material
29419SM	Hand drape, with elastic fenestration 3 cm	163/373x196 cm	1	SMS

## DYNJPE8005SM – Hand pack\*

18 ea/cs

Component	Description	Size	Comp qty.	Material
8610SM	Hand drape, with elastic fenestration 5 cm	196/371x292 cm	1	SMS

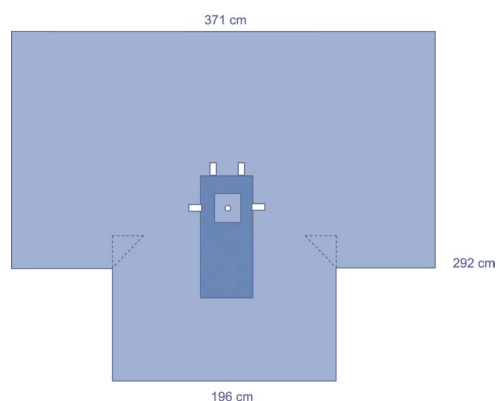

\*Delivered in wrap

## SM39418CE – Hand pack

10 ea/cs

Component	Description	Size	Comp qty.	Material
29419SM	Hand drape, with elastic fenestration 3 cm	163/373x196 cm	1	SMS
BTCM15	Back table cover, 50µm	140x190 cm	1	PP/PE
1025B	Wrap		1	SMS

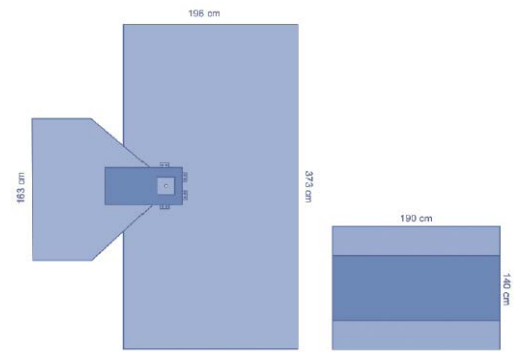

## TB39418CE – Hand pack

7 ea/cs

Component	Description	Size	Comp qty.	Material
TB29419	Hand drape, with elastic fenestration 3 cm	163/373x196 cm	1	Trilaminare
BTCM15	Back table cover, 50µm	140x190 cm	1	PP/PE
1025B	Wrap		1	SMS

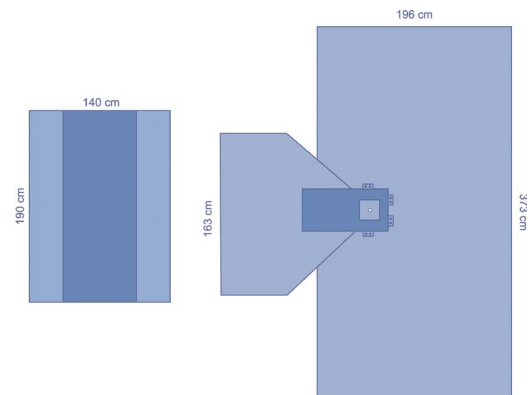

## SM29095CEA – Hand pack

8 ea/cs

Component	Description	Size	Comp qty.	Material
29419SM	Hand drape, with elastic fenestration 3 cm	163/373x196 cm	1	SMS
ES02C224	Drape sheet	150x150 cm	1	Bilaminare
BTCM15	Back table cover, 50µm	140x190 cm	1	PP/PE
1025B	Wrap		1	SMS

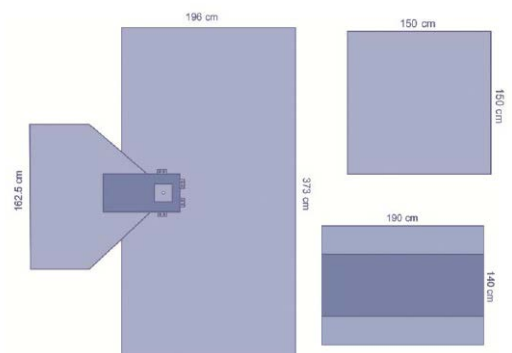

### ES29095CE – Hand pack

10 ea/cs

Component	Description	Size	Comp qty.	Material
7471	Absorbent hand towel	20x30 cm	2	Cellulose
ES02C224	Drape sheet	150x150 cm	1	Bilaminate
ES29419	Hand drape, with elastic fenestration 3 cm	163/373x196 cm	1	Bilaminate
BTCM15	Back table cover, 50µm	140x190 cm	1	PP/PE
1025B	Wrap		1	SMS

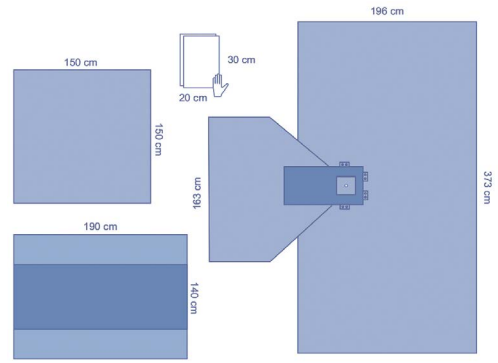

### TB29095CE – Hand pack

6 ea/cs

Component	Description	Size	Comp qty.	Material
BTCM16	Back table cover, 50µm, folded	140x190 cm	1	PP/PE
TB29419	Hand drape, with elastic fenestration 3 cm	163/373x196 cm	1	Trilaminate
BTCM15	Back table cover, 50µm	140x190 cm	1	PP/PE
1025B	Wrap		1	SMS

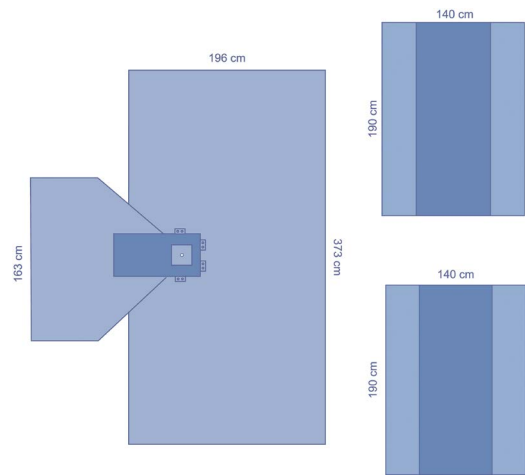

### SM29409CEA – Hand pack

8 ea/cs

Component	Description	Size	Comp qty.	Material
8339	Mayo stand cover	80x142 cm	1	PE
ES02C224	Drape sheet	150x150 cm	1	Bilaminate
29419SM	Hand drape, with elastic fenestration 3 cm	163/373x196 cm	1	SMS
8530	Absorbent hand towel	30x39 cm	2	Cellulose
TC060	Back table cover, 50µm	152x190 cm	1	PE

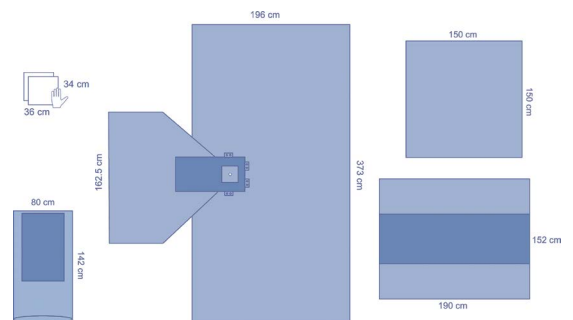



## TB29409CE – Hand pack

7 ea/cs

Component	Description	Size	Comp qty.	Material
8339	Mayo stand cover	80x142 cm	1	PE
8520	Absorbent hand towel	39x58 cm	1	Cellulose
TB29419	Hand drape, with elastic fenestration 3 cm	163/373x196 cm	1	Trilaminare
BTCM15	Back table cover, 50µm	140x190 cm	1	PP/PE
1025B	Wrap		1	SMS

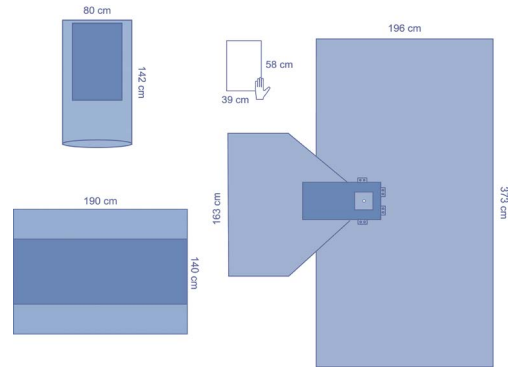

## CPU29022CE – Hand pack

4 ea/cs

Component	Description	Size	Comp qty.	Material
WS3540P	Essential OR gown, polyreinforced, MD/PPE	140 cm	1	SMS
8339	Mayo stand cover	80x142 cm	1	PE
8520	Absorbent hand towel	39x58 cm	4	Cellulose
ES02C211	Adhesive drape	90x75 cm	1	Bilaminare
ES30056	Adhesive drape	150x196 cm	1	Bilaminare
04A039	Instrument pouch, 1 compartment	33x41 cm	1	PE
7023W	Hook and loop tube holder	2,5x23 cm	2	Polyester
ZHE750	OP-tape	9x50 cm	3	Spunlace
TB29419	Hand drape, with elastic fenestration 3 cm	163/373x196 cm	1	Trilaminare
BTCM15	Back table cover, 50µm	140x190 cm	1	PP/PE
1025B	Wrap		1	SMS

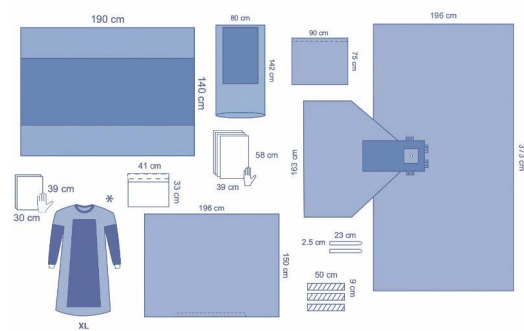

Scan the QR code to watch our draping instructions videos



# Hip drapes and packs

## DYNJPE8201SM – Hip drape with dislocation pouches\* 5 ea/cs

Component	Description	Size	Material
8290SM	Hip drape, with elastic fenestration 16x20 cm	221/285x352 cm	SMS

## TB29429CE – Hip drape with dislocation pouches\* 6 ea/cs

Component	Description	Size	Material
TB29429	Hip drape, with elastic fenestration 17x21 cm	217/290x350 cm	Trilaminare

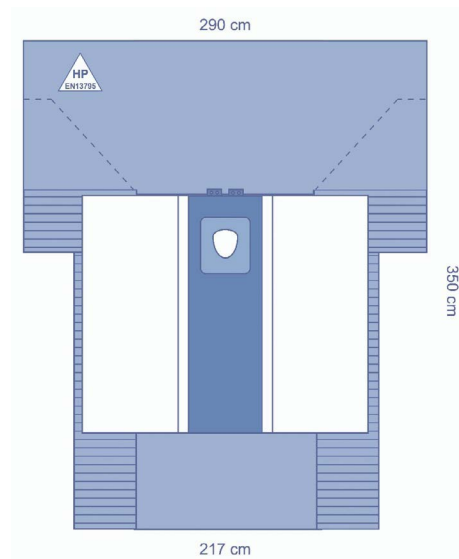

## ES29434LCE – Hip drape with dislocation pouches\* 12 ea/cs

Component	Description	Size	Material
ES29434L	Hip drape with left leg stockinette	245x310 cm	Bilaminare

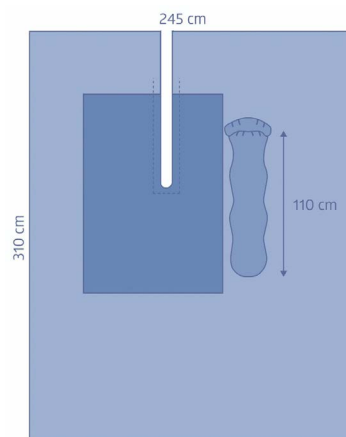

## ES29434RCE – Hip drape with dislocation pouches\* 12 ea/cs

Component	Description	Size	Material
ES29434R	Hip drape with right leg stockinette	245x310 cm	Bilaminare

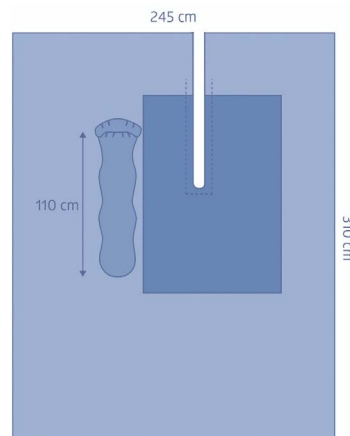

## ES29431CEA – Hip drape for anterior approach\*

5 ea/cs

Component	Description	Size	Material
ES29431	Hip drape with stockinette	360x400 cm	Bilaminare

Scan the QR code to watch our draping instructions videos

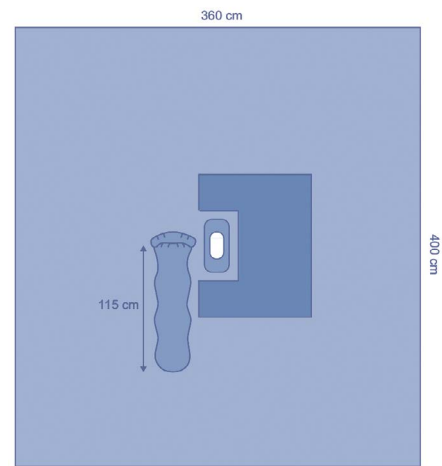

## ES29428CE – Hip pack

6 ea/cs

Component	Description	Size	Comp qty.	Material
8339	Mayo stand cover	80x142 cm	1	PE
ZHE750	OP-tape	9x50 cm	2	Spunlace
7471	Absorbent hand towel	20x30 cm	4	Cellulose
8475	Split drape, U adhesive 20x76 cm	152x213 cm	1	PE
30461E	Stockinette	30x122 cm	1	PP/PE
ES29429	Hip drape, with elastic fenestration 17x21 cm	217x290x350 cm	1	Bilaminare
BTCM15	Back table cover, 50µm	140x190 cm	1	PP/PE
1025B	Wrap		1	SMS

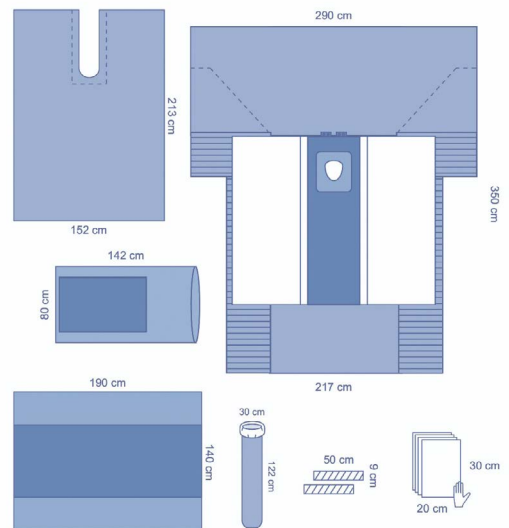

## 5801CE – Vertical isolation drape\*

16 ea/cs

Component	Description	Size	Material
5960	Clear VID, incise fenestration 78x32 cm	330x270 cm	Clear PE film

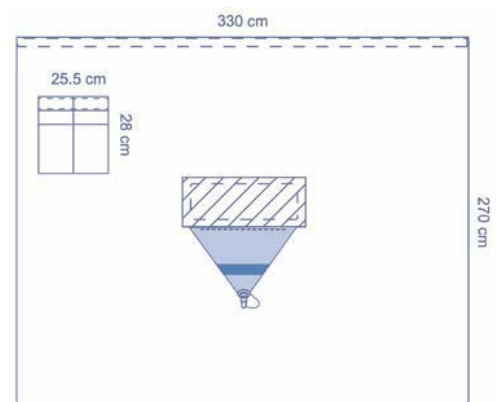

\*Delivered in wrap

### DYJPEHIPPSM – Hip pack

6 ea/cs

Component	Description	Size	Comp qty.	Material
MAYOM	Mayo stand cover	80x145 cm	1	PP/PE
2414SM	Drape sheet	135x196 cm	1	SMS
HNTOM	Absorbent hand towel	34x36 cm	4	Cellulose
E19298	Stockinette	30x122 cm	1	PP/PE
TAPSM	Non-woven adhesive tape	10x50 cm	2	SMS
IMPSOM	Split drape, U adhesive 25x75 cm	152x213 cm	1	PE
8290SM	Hip drape, with elastic fenestration 16x20 cm	221/285x352 cm	1	SMS
TC060	Back table cover, 50µm	152x190 cm	1	PE

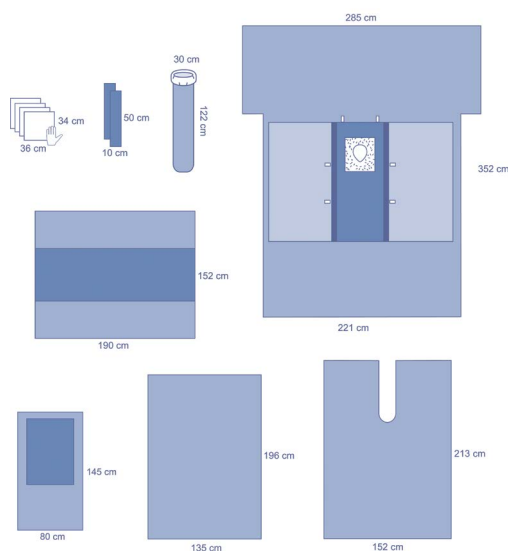

### 5803CE – Vertical isolation drape\*

10 ea/cs

Component	Description	Size	Material
8960	Bimaterial VID, incise fenestration 16x20 cm	330x246 cm	Bilaminate/ Clear PE

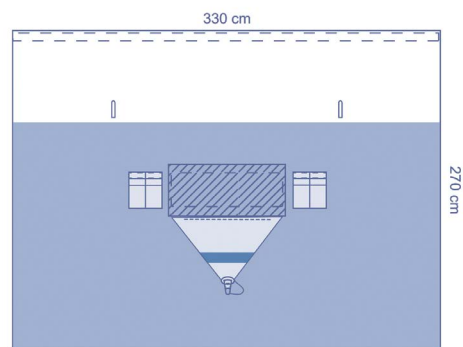

### IDE1017 – Vertical isolation drape

15 ea/cs

Component	Description	Size	Material
IDE1017	Clear VID, incise fenestration 48x25.5 cm	317x213 cm	Clear PE film

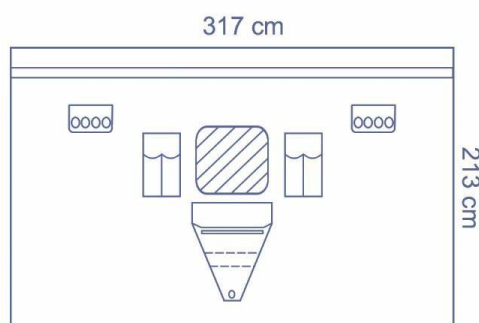

\*Delivered in wrap

## CP5802CE – Vertical isolation drape pack

12 ea/cs

Component	Description	Size	Comp qty.	Material
8520	Absorbent hand towel	39x58 cm	2	Cellulose
04A035	OP-tape	8x40 cm	1	PE
9684	Instrument pouch	25.5x28 cm	1	Clear PE film
7960	Vertical isolation drape, incise 78x26 cm	270x330 cm	1	PE
BTCM25	Back table cover, 75µm	140x190 cm	1	PP/PE
1025B	Wrap		1	SMS

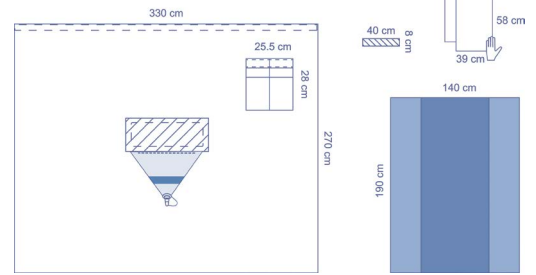

## TB29119CE – Vertical isolation drape pack

10 ea/cs

Component	Description	Size	Comp qty.	Material
8520	Absorbent hand towel	39x58 cm	1	Cellulose
8340C	Mayo stand cover, ultra-reinforced	80x145 cm	1	PP/PE
9684	Instrument pouch	25.5x28 cm	1	Clear PE film
7960	Vertical isolation drape, incise 78x26 cm	270x330 cm	1	PE
BTCM15	Back table cover, 50µm	140x190 cm	1	PP/PE

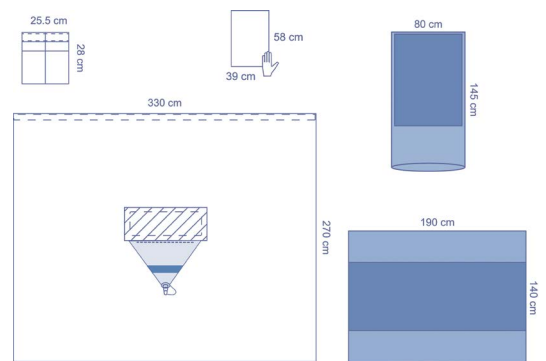

## CP29054CEA – Vertical isolation drape pack

4 ea/cs

Component	Description	Size	Comp qty.	Material
8520	Absorbent hand towel	39x58 cm	4	Cellulose
8339	Mayo stand cover	80x142 cm	1	PP/PE
ZHE750	OP-tape	9x50 cm	2	Spunlace
04A036	Instrument pouch, 2 compartments	33x41 cm	1	Clear PE
ES02C211	Adhesive drape	75x90 cm	6	Bilaminate
7023W	Hook and loop tube holder	2,5x23 cm	1	PET
6960	Vertical isolation drape, incise 26x86 cm	330x246 cm	1	Clear PE
BTCXL35	Back table cover, 90µm	203x240 cm	1	PP/PE
1025B	Wrap		1	SMS

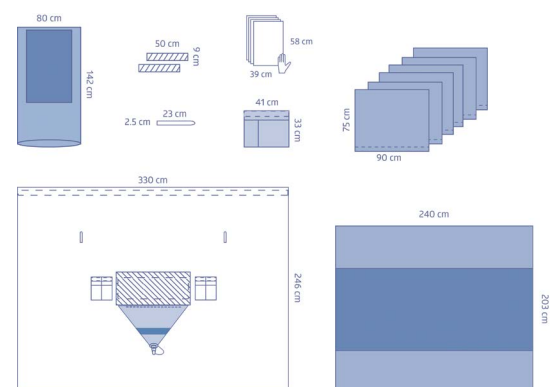

# Shoulder drapes and packs

## DYJPESHPSM2 – Split shoulder drape pack

6 ea/cs

Component	Description	Size	Comp qty.	Material
MAYOM	Mayo stand cover	80x145 cm	1	PP/PE
HNTOM	Absorbent hand towel	34x36 cm	4	Cellulose
2452SM	Shoulder split drape, adhesive	196x290 cm	1	SMS
8401SM	Shoulder split drape, with incise film, fluid collection pouch	254x168 cm	1	SMS
TC060	Back table cover, 50µm	152x190 cm	1	PE

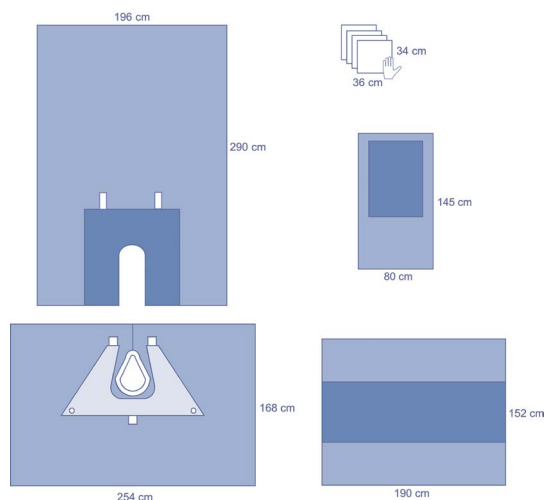

## ES10369CE – Beach chair shoulder drapes\*

6 ea/cs

Component	Description	Size	Comp qty.	Material
ES10369	Beach chair drape, with elastic fenestration 11 cm	411x262 cm	1	Bilaminate

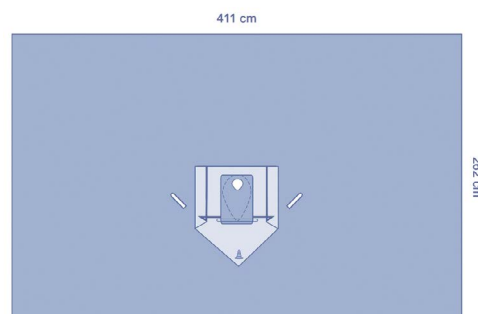

## TB29369CE – Beach chair shoulder drapes\*

6 ea/cs

Component	Description	Size	Comp qty.	Material
TB29369	Beach chair drape, with elastic fenestration 13 cm	411x262 cm	1	Trilaminate

\*Delivered in wrap



## TB29370CE – Beach chair shoulder drape

8 ea/cs

Component	Description	Size	Comp qty.	Material
TB29370	Bimaterial beach chair shoulder drape, with elastic fenestration 8 cm	411X262 cm	1	PE/ Trilaminate
1025B	Wrap		1	SMS

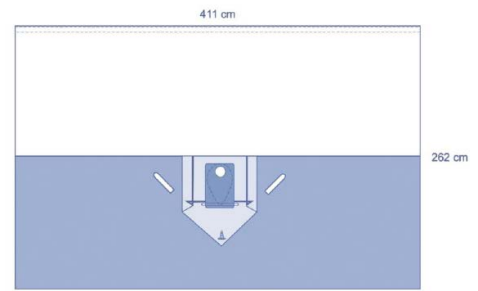

## ES10373CE – Beach chair drape pack

5 ea/cs

Component	Description	Size	Comp qty.	Material
8476	Split drape, U adhesive 15x53 cm	152x183 cm	1	PE
ES10369	Beach chair drape, with elastic fenestration 11 cm	262x411 cm	1	Bilaminate
BTCM15	Back table cover, 50µm	140x190 cm	1	PP/PE
1025B	Wrap		1	SMS

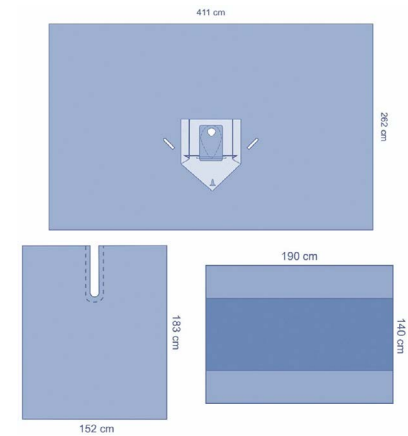

## ES10375CE – Beach chair drape pack

5 ea/cs

Component	Description	Size	Comp qty.	Material
8340	Mayo stand cover, ultra-reinforced	80x145 cm	1	PE
8476	Split drape, U adhesive 15x53 cm	152x183 cm	1	PE
7471	Absorbent hand towel	20x30 cm	2	Cellulose
ES10369	Beach chair drape, with elastic fenestration 11 cm	262x411 cm	1	Bilaminate
BTCM15	Back table cover, 50µm	140x190 cm	1	PP/PE

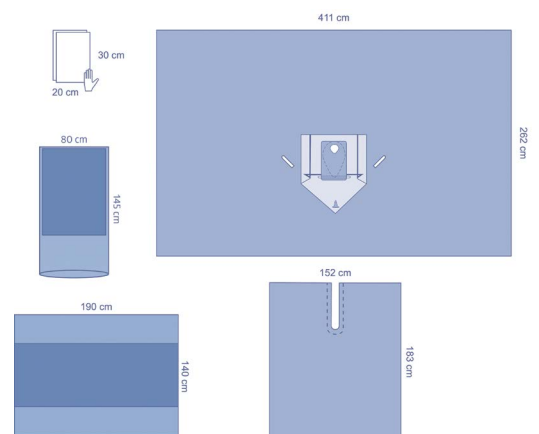

### CP29122CE – Beach chair drape pack

4 ea/cs

Component	Description	Size	Comp qty.	Material
9686ZD	Instrument pouch	29x27 cm	1	Spunlace
BTCM16	Back table cover, 50µm	140x190 cm	1	PP/PE
TB30056	Adhesive drape	150x196 cm	1	Trilaminare
7014WP	Hook and loop tube holder	2,5x14 cm	2	Polyester
TB29369	Beach chair drape, with elastic fenestration 13 cm	262x411 cm	1	Trilaminare
BTCM15	Back table cover, 50µm	140x190 cm	1	PP/PE
1025B	Wrap		1	SMS

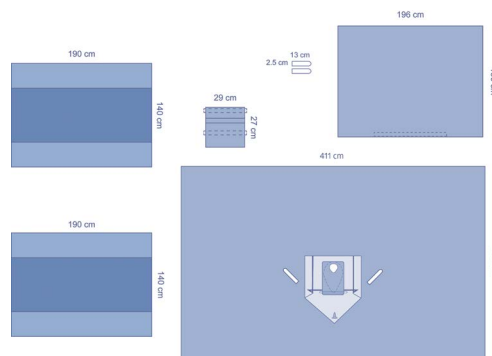

### TB29371CE – Beach chair drape pack

4 ea/cs

Component	Description	Size	Comp qty.	Material
8530	Absorbent hand towel	30x39 cm	2	Cellulose
8340	Mayo stand cover, ultra-reinforced	80x145 cm	1	PE
ES02C211	Adhesive drape	75x90 cm	3	Bilaminare
ZHE750	OP-tape	9x50 cm	2	Spunlace
36975E	Stockinette	20x97 cm	1	PP/PE
7023W	Hook and loop tube holder	2,5x23 cm	2	
TB29369	Beach chair drape, with elastic fenestration 13 cm	262x411 cm	1	Trilaminare
BTCL35	Back table cover, 90µm	160x240 cm	1	PP/PE

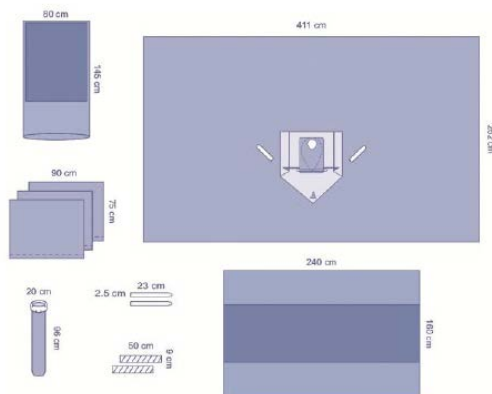

### DYJPESHPSM3 – Beach chair drape pack

6 ea/cs

Component	Description	Size	Comp qty.	Material
MAYOM	Mayo stand cover	80x145 cm	1	PP/PE
HNTOM	Absorbent hand towel	34x36 cm	4	Cellulose
E12139	Split drape, U adhesive 15x61 cm	137x193 cm	1	PE
8404SM	Beach chair drape, with elastic fenestration 10 cm	404x268 cm	1	SMS
TC060	Back table cover, 50µm	152x190 cm	1	PE

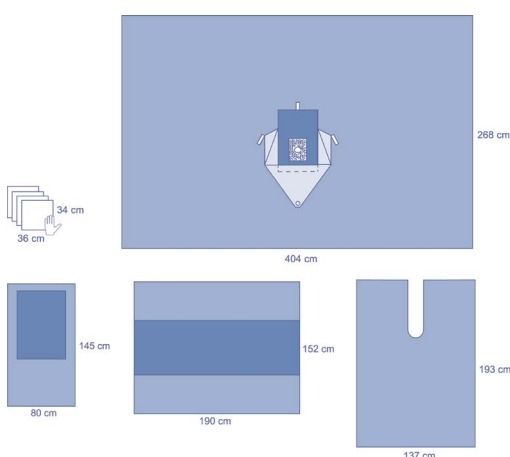

### DYJPESHPSM3 – Beach chair drape pack

6 ea/cs

Component	Description	Size	Comp qty.	Material
MAYOM	Mayo stand cover	80x145 cm	1	PP/PE
HNTOM	Absorbent hand towel	34x36 cm	4	Cellulose
E12139	Split drape, U adhesive 15x61 cm	137x193 cm	1	PE
8404SM	Beach chair drape, with elastic fenestration 10 cm	404x268 cm	1	SMS
TC060	Back table cover, 50µm	152x190 cm	1	PE

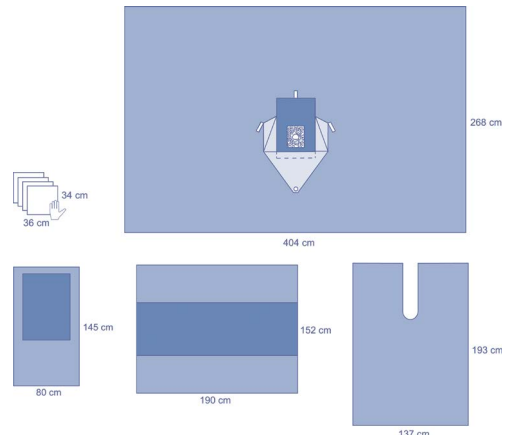

### TB29365CE – Split shoulder drape pack

9 ea/cs

Component	Description	Size	Comp qty.	Material
TB9361	Shoulder drape, with adhesive split 25x64cm, PE reinforcement	196 x 295 cm	1	Trilaminare
TB29365	Shoulder drape, with pear-shaped split and incise film	254x160 cm	1	Trilaminare
1025B	Wrap		1	SMS

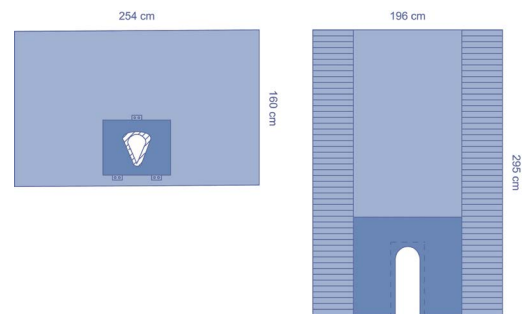

### TB29367CE – Split shoulder drape pack

8 ea/cs

Component	Description	Size	Comp qty.	Material
TB9361	Shoulder drape, with adhesive split 25x64cm, PE reinforcement	196 x 295 cm	1	Trilaminare
TB9360	Shoulder drape, with pear-shaped split and incise film	160x254 cm	1	Trilaminare
1025B	Wrap		1	SMS

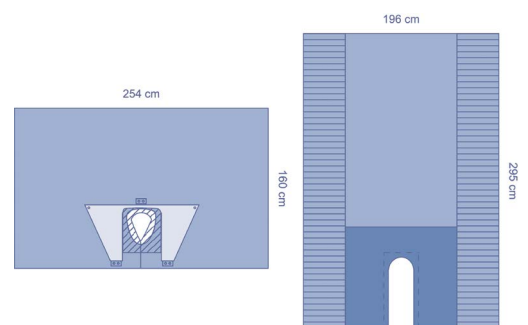

**TB29368CE – Split shoulder drape pack**

6 ea/cs

Component	Description	Size	Comp qty.	Material
ZHE750	OP-tape	9x50 cm	2	Spunlace
7471	Absorbent hand towel	20x30 cm	4	Cellulose
TB9361	Shoulder drape, with adhesive split 25x64cm, PE reinforcement	196 x 295 cm	1	Trilaminare
TB9360	Shoulder drape, with pear-shaped split and incise film	160x254 cm	1	Trilaminare
BTCM15	Back table cover, 50µm	140x190 cm	1	PP/PE
1025B	Wrap		1	SMS

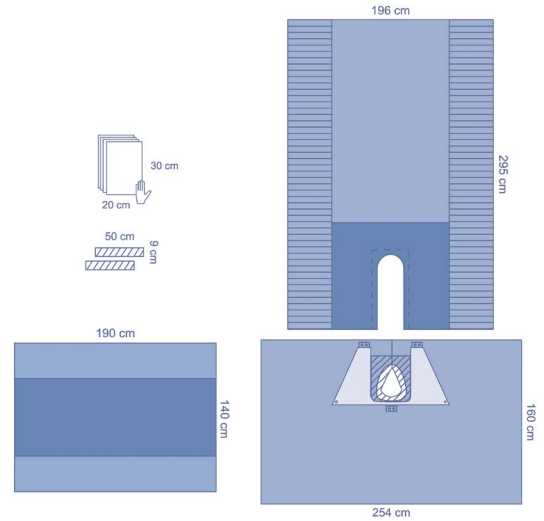

Scan the QR code to watch our draping instructions videos



# Split drapes and packs

## IDE1015 – Clear split drapes

15 ea/cs

Component	Description	Size	Comp qty.	Material
IDE1015	Split drape, U adhesive 15x48 cm	122x132 cm	1	Clear PE
IDE1019	Split drape, U adhesive 15x48 cm	122x180 cm	1	Clear PE

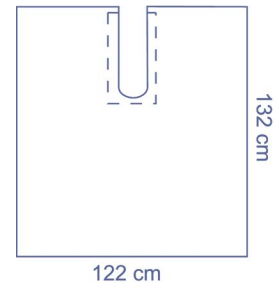

## DYJPESPSSM1 – Reinforced split drape

20 ea/cs

Component	Description	Size	Comp qty.	Material
SPSSM1	Split drape, U adhesive 6x60 cm	135x178 cm	1	SMS
1025B	Wrap		1	SMS

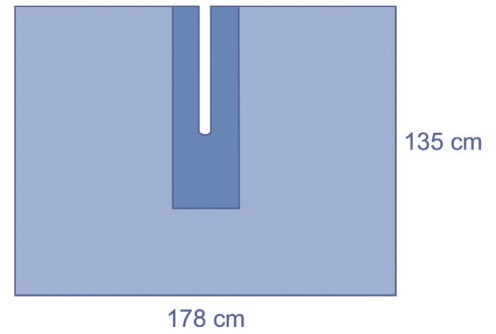

**ES10438CE – Split drape**

28 ea/cs

Component	Description	Size	Material
ES10438	Split drape, U adhesive 20x102 cm	200 x 260 cm	Bilaminate

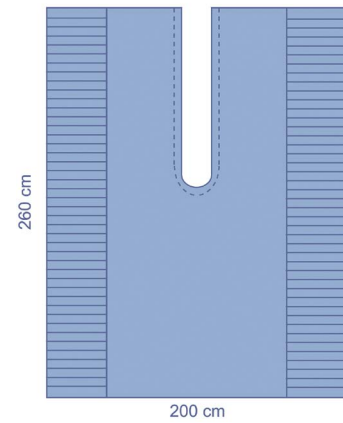

**8474CEA – Polyethylene split drapes\***

36 ea/cs

Component	Description	Size	Material
8474	Split drape, U adhesive 15x53 cm	152x152 cm	Blue PE

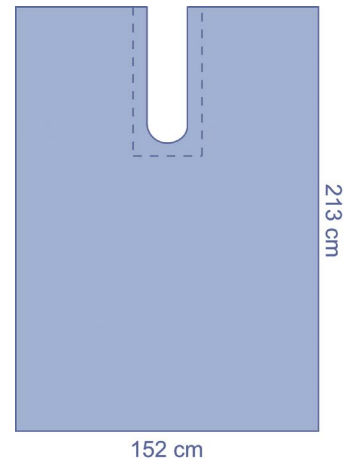

**8475CEA – Polyethylene split drapes\***

28 ea/cs

Component	Description	Size	Material
8475	Split drape, U adhesive 20x76 cm	152x213 cm	Blue PE

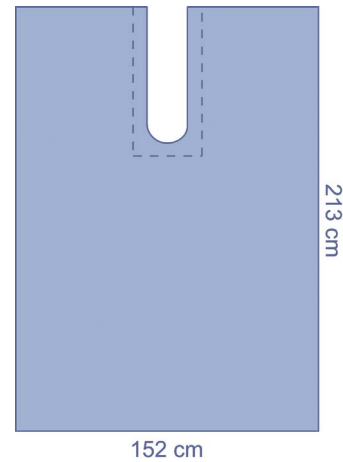

**8476CEA – Polyethylene split drapes\***

40 ea/cs

Component	Description	Size	Material
8476	Split drape, U adhesive 15x53 cm	152x183 cm	Blue PE

**DYJPESPSSM2 – Reinforced split drapes\***

10 ea/cs

Component	Description	Size	Material
SPSSM2	Split drape, U adhesive 6x94 cm	196x274 cm	SMS

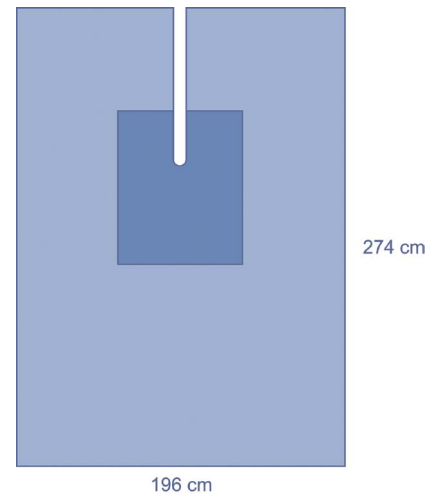

**DYJPESPSSM3 – Reinforced split drapes\***

6 ea/cs

Component	Description	Size	Material
SPSSM3	Split drape, U adhesive 8x107 cm	220x300 cm	SMS

\*Delivered in wrap

**TB29423CE — Reinforced split drapes\***

12 ea/cs

Component	Description	Size	Material
TB29423	Split drape, U adhesive 6x94 cm	196 x 275 cm	Trilaminate

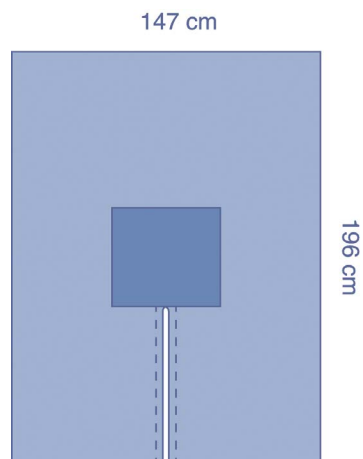

**TB29434CE — Reinforced split drapes\***

24 ea/cs

Component	Description	Size	Material
TB29434	Split drape, U adhesive 3x72 cm	147x196 cm	Trilaminate

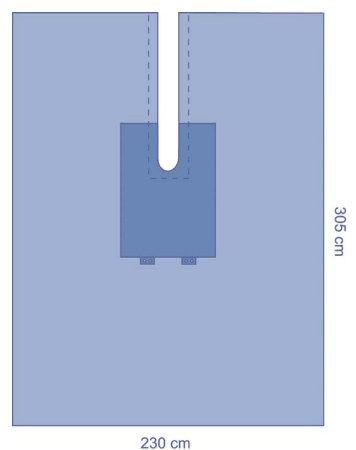

**DYNJPE8301 — Reinforced split drapes\***

10 ea/cs

Component	Description	Size	Material
2451S	Split drape, U adhesive 15x102 cm	196x274 cm	Spunlace

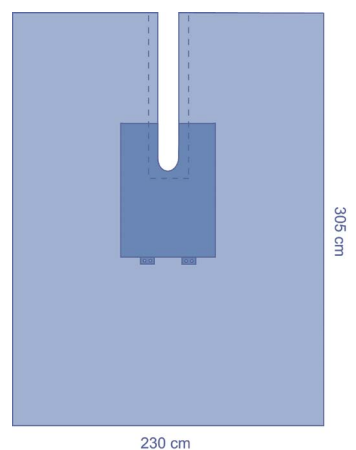

**ES29442CE — Reinforced split drapes\***

16 ea/cs

Component	Description	Size	Material
ES29442	Split drape, U adhesive 15x117 cm	230x305 cm	Bilaminate

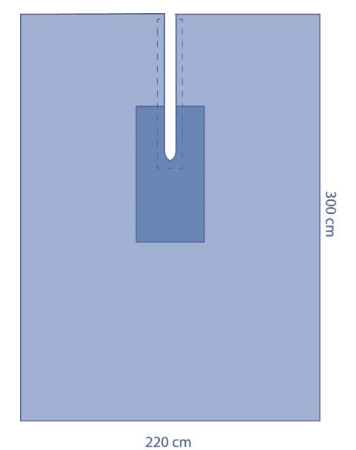

**ES29425CE — Reinforced split drapes\***

42 ea/cs

Component	Description	Size	Material
ES29425	Split drape, U adhesive 7x65 cm	150 x 200 cm	Bilaminate

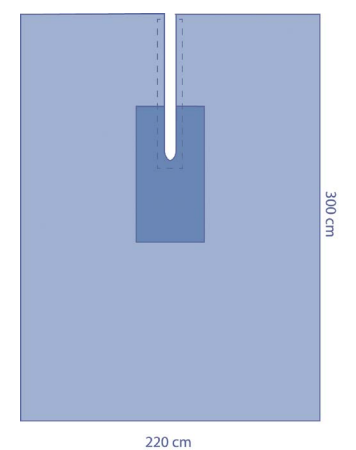

**ES9424CE — Reinforced split drapes\***

14 ea/cs

Component	Description	Size	Material
ES9424	Split drape, U adhesive 8,5x107 cm	220x300 cm	Bilaminate

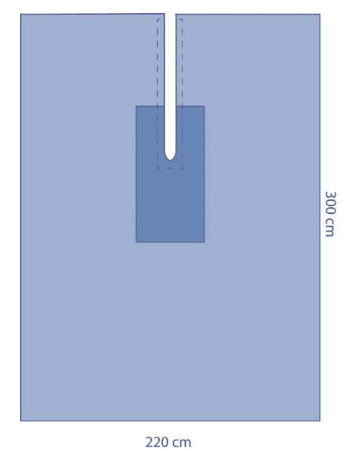

\*Delivered in wrap



**TB9437CE – Reinforced split drape**

10 ea/cs

Component	Description	Size	Comp qty.	Material
1025B	Wrap		1	SMS
TB29433	Split drape, U adhesive 7x110 cm	240x304 cm	1	Trilaminate

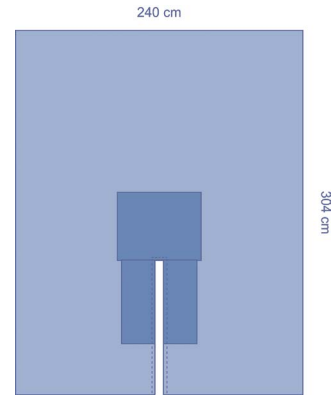

**TB29436CE – Reinforced split drape with narrow adhesive**

12 ea/cs

Component	Description	Size	Comp qty.	Material
1025B	Wrap		1	SMS
TB29436	Split drape, U adhesive 6x94 cm	196x274 cm	1	Trilaminate

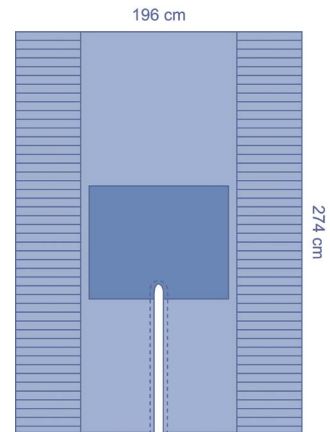

**ES29620CE – Universal split pack**

8 ea/cs

Component	Description	Size	Comp qty.	Material
8339	Mayo stand cover	80x142 cm	1	PE
ZHE750	OP-tape	9x50 cm	2	Spunlace
7471	Absorbent hand towel	20x30 cm	4	Cellulose
ES29444	Side drape, reinforced	110x95 cm	1	Bilaminate
ES10483	Head drape	160x260 cm	1	Bilaminate
ES29440	Split drape, U adhesive 15x117 cm	196x305 cm	1	Bilaminate
BTCM15	Back table cover, 50µm	140x190 cm	1	PP/PE

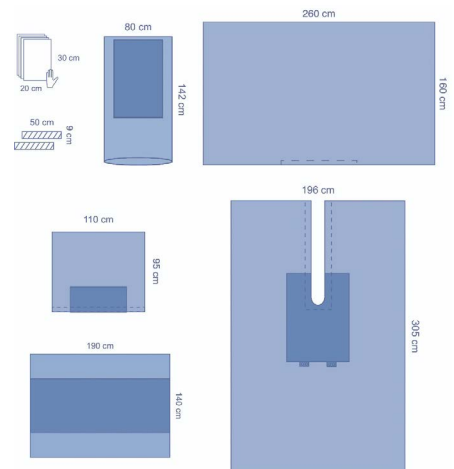

## ES10132CE – Universal split pack

8 ea/cs

Component	Description	Size	Comp qty.	Material
8339	Mayo stand cover	80x142 cm	1	PE
7471	Absorbent hand towel	20x30 cm	4	Cellulose
ES10482	Head drape	240x150 cm	1	Bilaminate
ES10132	Split drape, U adhesive 7x95 cm	200x250 cm	1	Bilaminate
BTCM15	Back table cover, 50µm	140x190 cm	1	PP/PE

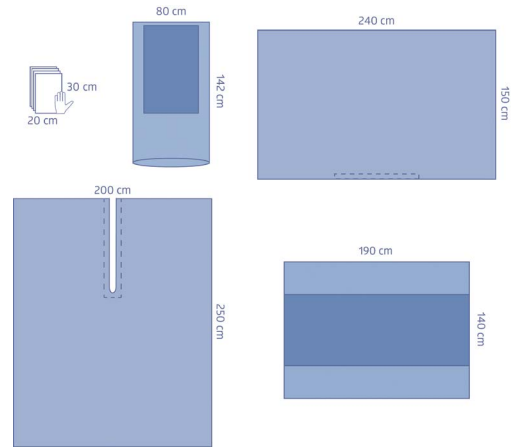

## TB29038CE – Reinforced split drape

10 ea/cs

Component	Description	Size	Comp qty.	Material
1025B	Wrap		1	SMS
TB29038	Split drape, U adhesive 11x94 cm	240x290 cm	1	Trilaminate

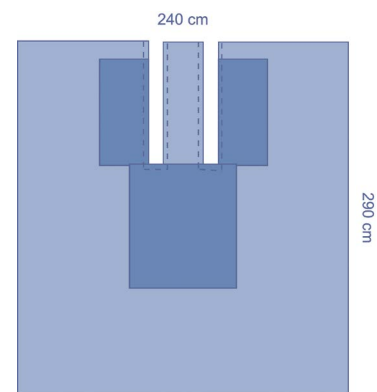

## ES29113CE – Universal split pack

4 ea/cs

Component	Description	Size	Comp qty.	Material
8338	Mayo stand cover	80x142 cm	1	PE
7471	Absorbent hand towel	20x30 cm	2	Cellulose
ZHE750	OP-tape	9x50 cm	2	Spunlace
ES02C211	Adhesive drape	75x90 cm	1	Bilaminate
TC060	Back table cover, 50µm	152x190 cm	1	PE
ES9424	Split drape, U adhesive 8,5x107 cm	220x300 cm	1	Bilaminate
ES2932	Head drape, reinforced	260x182 cm	1	Bilaminate
TC060	Back table cover, 50µm	152x190 cm	1	PE

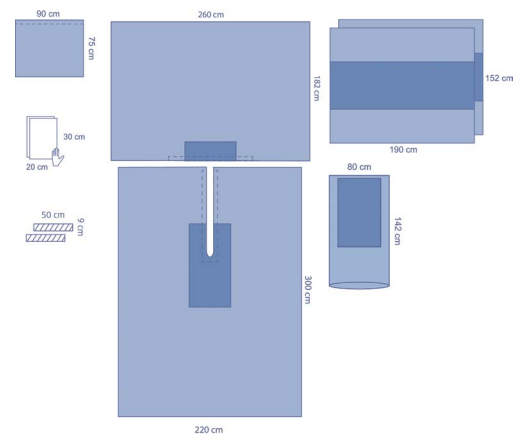

### TB29113CE – Universal split pack

6 ea/cs

Component	Description	Size	Comp qty.	Material
8339	Mayo stand cover	80x142 cm	1	PE
8520	Absorbent hand towel	39x58 cm	1	Cellulose
04A039	Instrument pouch, 1 compartment	33x41cm	1	PE
TB29440	Split drape, U adhesive 15x116 cm	196x305 cm	1	Trilaminare
TB29195	Head drape, with armboard covers	269x157 cm	1	Trilaminare
BTCL25	Back table cover, 75µm	160x240 cm	1	PP/PE
1025B	Wrap		1	SMS

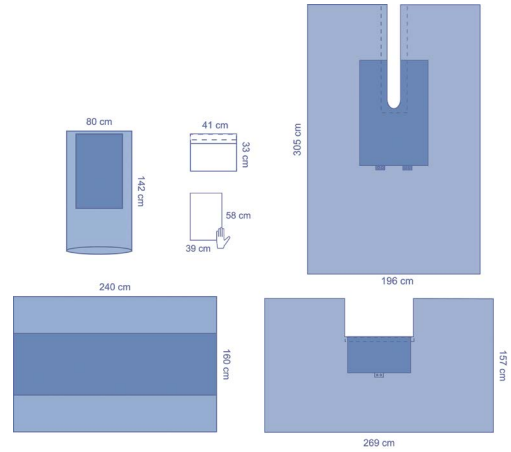

### TB29132CE – Universal split pack

6 ea/cs

Component	Description	Size	Comp qty.	Material
8339	Mayo stand cover	80x142 cm	1	PE
471	Absorbent hand towel	20x30 cm	4	Cellulose
TB29432	Split drape, U adhesive 15x102 cm	196x254 cm	1	Trilaminare
TB29476	Head drape, reinforced	254x183 cm	1	Trilaminare
BTCM15	Back table cover, 50µm	140x190 cm	1	PP/PE

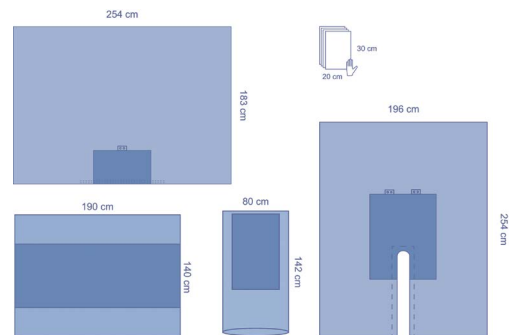

### TB29131CE – Universal split pack

6 ea/cs

Component	Description	Size	Comp qty.	Material
8520	Absorbent hand towel	39x58 cm	4	Cellulose
5144	Suture bag	16x31 cm	1	Paper
8337	Mayo stand cover	59x141 cm	1	PP/PE
TB29351	Head drape, reinforced	251x135 cm	1	Trilaminare
TB29440	Split drape, U adhesive 15x116 cm	196x305 cm	1	Trilaminare

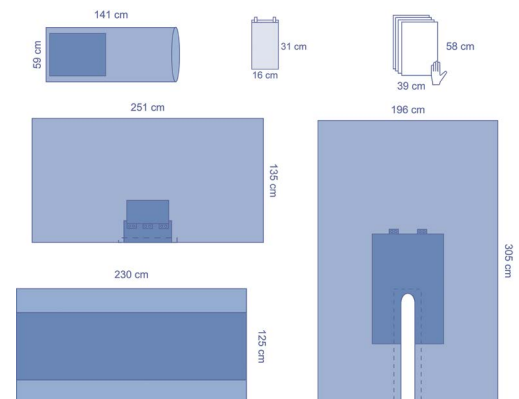

## CPU29006CE – Universal split pack

2 ea/cs

Component	Description	Size	Comp qty.	Material										
WS3540P	Essential OR gown, polyreinforced, MD/PPE	140 cm	1	SMS										
8530	Absorbent hand towel	30x39 cm	6	Cellulose										
S3513P	Essential OR gown, polyreinforced, MD/PPE	140 cm	1	SMS										
BTCL26	Back table cover, 75µm	160x240 cm	1	PP/PE										
ES02C211	Adhesive drape	90x75 cm	2	Bilaminate										
TB29444	Side drape, reinforced	98x120 cm	2	Trilaminate										
8530	Absorbent hand towel	30x39 cm	6	Cellulose										
S3513P	Essential OR gown, polyreinforced, MD/PPE	140 cm	1	SMS										
8339	Mayo stand cover	80x142 cm	1	PE										
7023W	Hook and loop tube holder	2,5x23 cm	2											
ES9424	Split drape, U adhesive 8,5x107 cm	220x300 cm	1	Bilaminate										
04A036	Instrument pouch, 2 compartments	33x41 cm	1	Clear PE film										
ZHE750	OP-tape	9x50 cm	2	Spunlace										
TB29473	Foot drape, reinforced	196x200 cm	1	Trilaminate										
TB29476	Head drape, reinforced	254x183 cm	1	Trilaminate </tr <tr> <td>BTCL35</td> <td>Back table cover, 90µm</td> <td>160x240 cm</td> <td>1</td> <td>PP/PE</td> </tr> <tr> <td>1025B</td> <td>Wrap</td> <td></td> <td>1</td> <td>SMS</td> </tr>	BTCL35	Back table cover, 90µm	160x240 cm	1	PP/PE	1025B	Wrap		1	SMS
BTCL35	Back table cover, 90µm	160x240 cm	1	PP/PE										
1025B	Wrap		1	SMS										

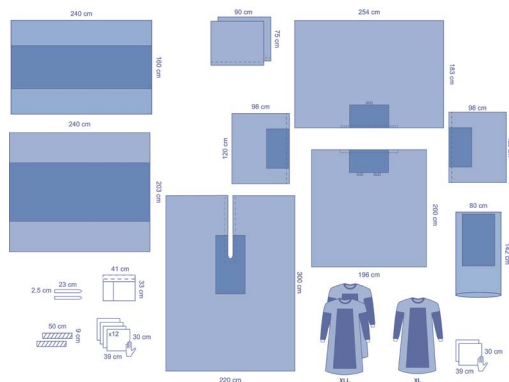

Orthopaedic

## ES29116CE – Orthopaedic split pack

4 ea/cs

Component	Description	Size	Comp qty.	Material
7471	Absorbent hand towel	20x30 cm	2	Cellulose
ZHE750	OP-tape	9x50 cm	2	Spunlace
ES02C224	Drape sheet	150x150 cm	1	Bilaminate
8475	Split drape, U adhesive 20x76 cm	152x213 cm	1	Blue PE
ES9424	Split drape, U adhesive 8,5x107 cm	220x300 cm	1	Bilaminate
ES2932	Head drape, reinforced	260x182 cm	1	Bilaminate
BTCM15	Back table cover, 50µm	140x190 cm	1	PP/PE
1025B	Wrap		1	SMS

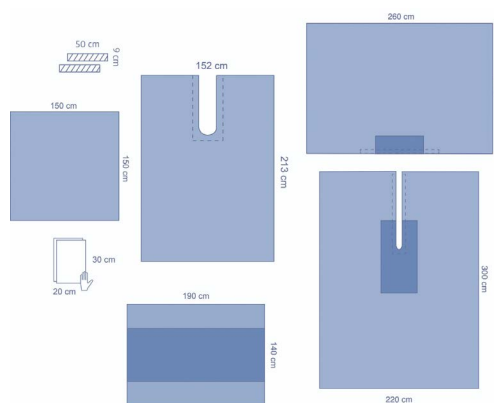

### ES29117CE – Orthopaedic split pack

4 ea/cs

Component	Description	Size	Comp qty.	Material
BTCM16	Back table cover, 50µm	140x190 cm	1	PP/PE
7471	Absorbent hand towel	20x30 cm	2	Cellulose
ZHE750	OP-tape	9x50 cm	2	Spunlace
ES02C224	Drape sheet	150x150 cm	1	Bilaminate
8475	Split drape, U adhesive 20x76 cm	152x213 cm	1	Blue PE
ES9424	Split drape, U adhesive 8,5x107 cm	220x300 cm	1	Bilaminate
ES2932	Head drape, reinforced	260x182 cm	1	Bilaminate
BTCM15	Back table cover, 50µm	140x190 cm	1	PP/PE
1025B	Wrap		1	SMS

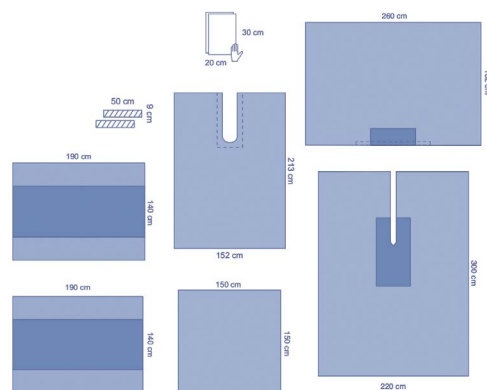

### ES29642CE – Orthopaedic split pack

6 ea/cs

Component	Description	Size	Comp qty.	Material
8340C	Mayo stand cover, ultra-reinforced	80x145 cm	1	PE
ES27012	Stockinette	35x90cm	1	Bilaminate
04A035	OP-tape	8x40 cm	5	PE
ES11601	Foot drape	190x190 cm	1	Bilaminate
ES294425	Split drape, U adhesive 15x117 cm	305x330cm	1	Bilaminate
ES8023	Adhesive drape	300x221 cm	1	Bilaminate
BTCM15	Back table cover, 50µm	140x190 cm	1	PP/PE

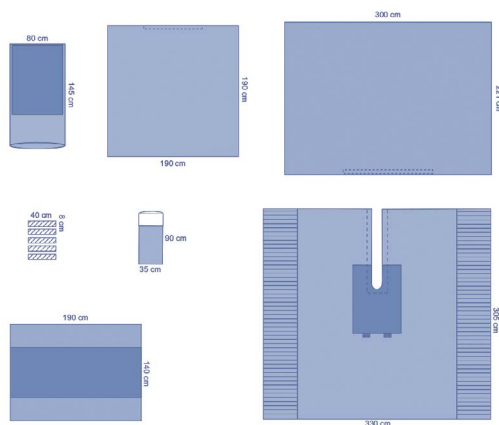

### ES29641CE – Orthopaedic split pack

6 ea/cs

Component	Description	Size	Comp qty.	Material
8340	Mayo stand cover, ultra-reinforced	80x145 cm	1	PE
ES27011	Stockinette	30x120 cm	1	Bilaminate
04A035	OP-tape	8x40 cm	5	PE
ES11601	Foot drape	190x190 cm	1	Bilaminate
ES29442	Split drape, U adhesive 15x117 cm	230x305 cm	1	Bilaminate
ES8023	Adhesive drape	300x221 cm	1	Bilaminate
BTCM15	Back table cover, 50µm	140x190 cm	1	PP/PE

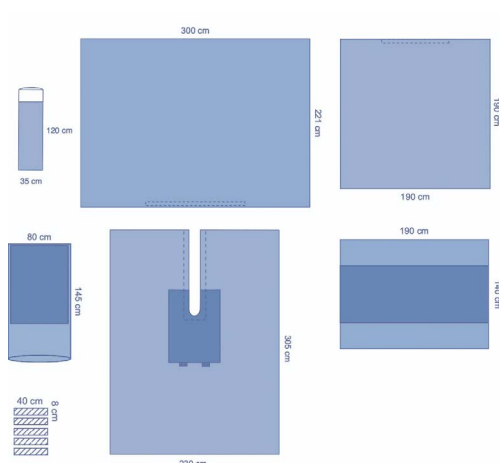

## ES29630CE – Orthopaedic split pack

6 ea/cs

Component	Description	Size	Comp qty.	Material
8340	Mayo stand cover, ultra-reinforced	80x145 cm	1	PE
84755	Split drape, U adhesive 20x76 cm	152 x 213 cm	1	Blue PE
8530	Absorbent hand towel	30x39 cm	2	Cellulose
ZHE750	OP-tape	9x50 cm	2	Spunlace
30461E	Stockinette	30x122 cm	1	PP/PE
ES02C235	Drape sheet	100x100 cm	1	Bilaminate
ES294331	Split drape, U adhesive 7x108 cm	240x304 cm	1	Bilaminate
ES29480	Head drape, reinforced	260x170 cm	1	Bilaminate
BTCM15	Back table cover, 50µm	140x190 cm	1	PP/PE
1025B	Wrap		1	SMS

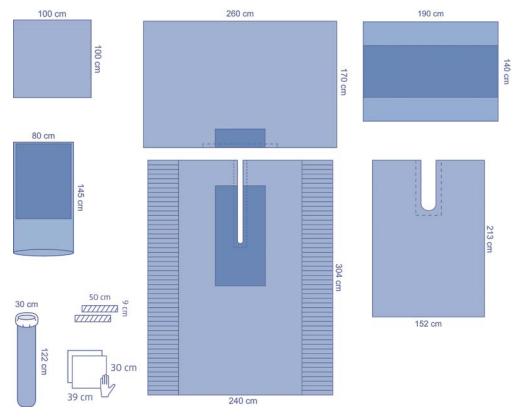

## TB9650CE – Orthopaedic split pack

6 ea/cs

Component	Description	Size	Comp qty.	Material
MAYOM	Mayo stand cover	80x145 cm	1	PP/PE
BTCM16	Back table cover, 50µm	140x190 cm	1	PP/PE
7471	Absorbent hand towel	20x30 cm	2	Cellulose
TB29423	Split drape, U adhesive 6x94 cm	196 x 275 cm	1	Trilaminare
TB29476	Head drape, reinforced	254x183 cm	1	Trilaminare
BTCM15	Back table cover, 50µm	140x190 cm	1	PP/PE

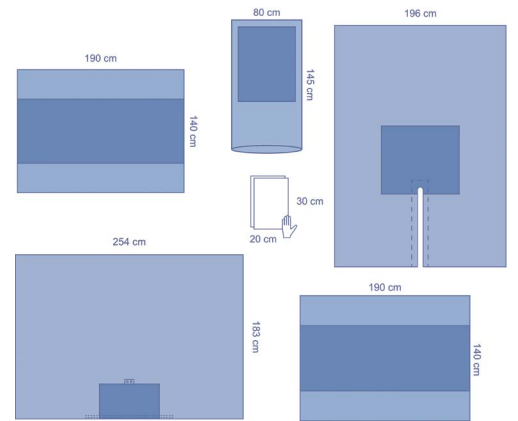

## TB29215CEA – Orthopaedic split pack

5 ea/cs

Component	Description	Size	Comp qty.	Material
7471	Absorbent hand towel	20x30 cm	2	Cellulose
04A035	OP-tape	8x40 cm	4	PE
TB9461	Utility drape	98x98 cm	1	Trilaminare
8475	Split drape, U adhesive 20x76 cm	152x213 cm	1	Blue PE
TB29433	Split drape, U adhesive 7x110 cm	240x304 cm	1	Trilaminare
TB29476	Head drape, reinforced	254x183 cm	1	Trilaminare
BTCM15	Back table cover, 50µm	140x190 cm	1	PP/PE
1025B	Wrap		1	SMS

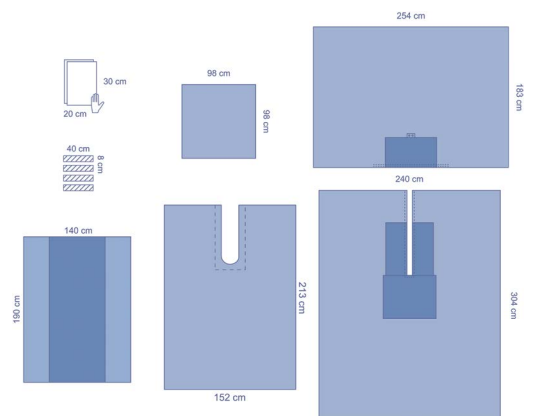

### TB29116CE – Orthopaedic split pack

4 ea/cs

Component	Description	Size	Comp qty.	Material
8520	Absorbent hand towel	39x58 cm	2	Cellulose
04A035	OP-tape	8x40 cm	2	PE
03C221	Drape sheet	98x150 cm	1	PP/PE
8475	Split drape, U adhesive 20x76 cm	152x213 cm	1	Blue PE
TB9424	Split drape, U adhesive 6x64 cm	196x274 cm	1	Trilaminare
TB2931	Head drape, reinforced	183x254 cm	1	Trilaminare
BTCM15	Back table cover, 50µm	140x190 cm	1	PP/PE
1025B	Wrap		1	SMS

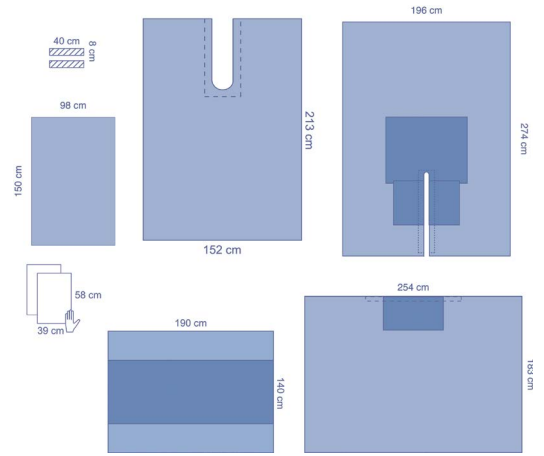

### TB29117CE –Orthopaedic split pack

4 ea/cs

Component	Description	Size	Comp qty.	Material
BTCM16	Back table cover, 50µm	140x190 cm	1	PP/PE
8520	Absorbent hand towel	39x58 cm	2	Cellulose
04A035	OP-tape	8x40 cm	2	PE
8475	Split drape, U adhesive 20x76 cm	152x213 cm	1	Blue PE
TB9424	Split drape, U adhesive 6x64 cm	196x274 cm	1	Trilaminare
TB2931	Head drape, reinforced	183x254 cm	1	Trilaminare
BTCM15	Back table cover, 50µm	140x190 cm	1	PP/PE
1025B	Wrap		1	SMS

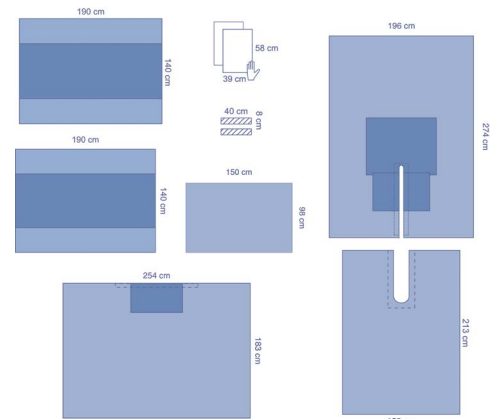

### TB29509CE – Orthopaedic split pack

6 ea/cs

Component	Description	Size	Comp qty.	Material
30461E	Stockinette	30x122 cm	1	PP/PE
8475	Split drape, U adhesive 20x76 cm	152x213 cm	1	Blue PE
TB29440	Split drape, U adhesive 15x116 cm	196x305 cm	1	Trilaminare
TB29478	Head drape, reinforced	254x183 cm	1	Trilaminare
BTCM15	Back table cover, 50µm	140x190 cm	1	PP/PE

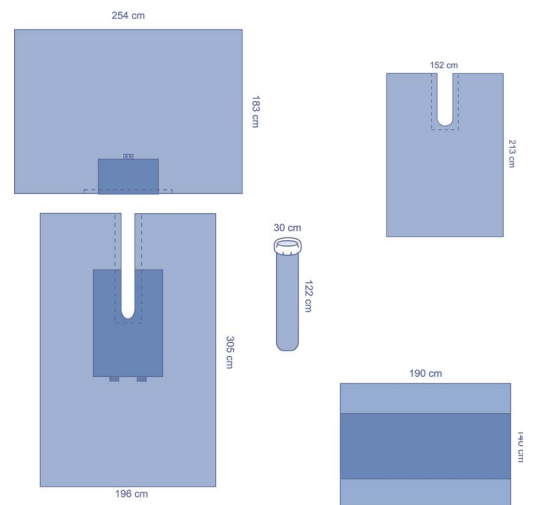



## TB29640CE – Orthopaedic split pack

5 ea/cs

Component	Description	Size	Comp qty.	Material
8340C	Mayo stand cover, ultra-reinforced	80x145 cm	1	PP/PE
BTCM16	Back table cover, 50µm	140x190 cm	1	PP/PE
7471	Absorbent hand towel	20x30 cm	2	Cellulose
30461E	Stockinette	30x122 cm	1	PP/PE
TB9461	Utility drape	98x98 cm	1	Trilaminate
ZHE750	OP-tape	9x50 cm	2	Spunlace
TB29440	Split drape, U adhesive 15x116 cm	196x305 cm	1	Trilaminate
TB29476	Head drape, reinforced	254x183 cm	1	Trilaminate
BTCM15	Back table cover, 50µm	140x190 cm	1	PP/PE

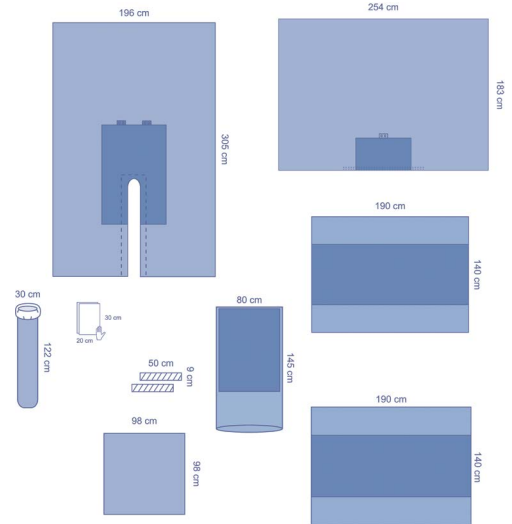

## TB29630CE – Orthopaedic split pack

4 ea/cs

Component	Description	Size	Comp qty.	Material
8340C	Mayo stand cover, ultra-reinforced	80x145 cm	1	PP/PE
TB9461	Utility drape	98x98 cm	1	Trilaminate
8475	Split drape, U adhesive 20x76 cm	152x213 cm	1	Blue PE
7471	Absorbent hand towel	20x30 cm	2	Cellulose
30461E	Stockinette	30x122 cm	1	PP/PE
ZHE750	OP-tape	9x50 cm	2	Spunlace
TB29433	Split drape, U adhesive 7x110 cm	240x304 cm	1	Trilaminate
TB29476	Head drape, reinforced	254x183 cm	1	Trilaminate
BTCM15	Back table cover, 50µm	140x190 cm	1	PP/PE

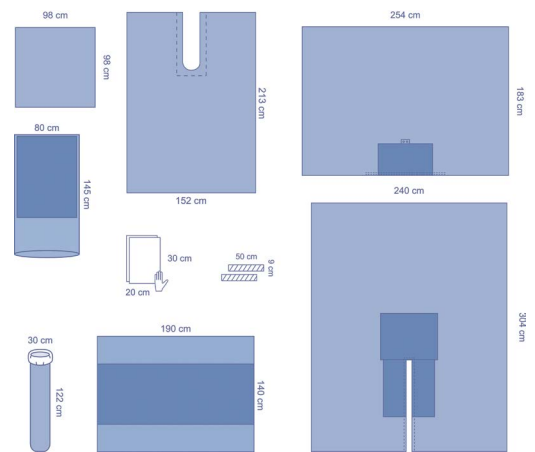

## TB29690CE – Orthopaedic split pack

4 ea/cs

Component	Description	Size	Comp qty.	Material
8340C	Mayo stand cover, ultra-reinforced	80x145 cm	1	PP/PE
7471	Absorbent hand towel	20x30 cm	2	Cellulose
ES02C221	Drape sheet	75x90 cm	1	Bilaminate
30461E	Stockinette	30x122 cm	1	PP/PE
8483	Under-buttock drape	96x126 cm	1	PP/PE
8475	Split drape, U adhesive 20x76 cm	152x213 cm	1	Blue PE
ZHE750	OP-tape	9x50 cm	1	Spunlace
TB29433	Split drape, U adhesive 7x110 cm	240x304 cm	1	Trilaminate
TB2945	Head drape, reinforced	340x196 cm	1	Trilaminate
BTCL35	Back table cover, 90µm	160x240 cm	1	PP/PE

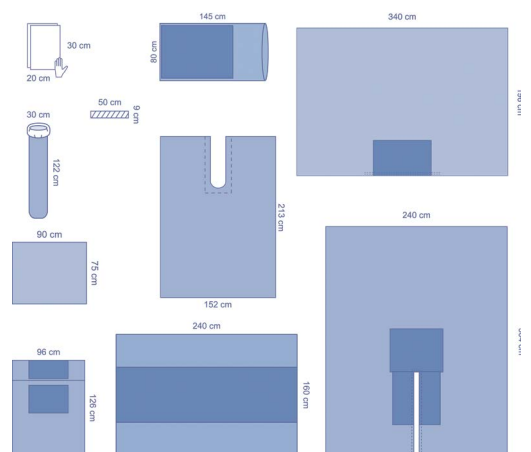

**TB29181CE – Orthopaedic split pack**

4 ea/cs

Component	Description	Size	Comp qty.	Material
8530	Absorbent hand towel	30x39 cm	4	Cellulose
IQ9041	Ultimate OR gown	XL, 130 cm	2	Trilaminate
8339	Mayo stand cover	80x142 cm	1	PE
29960	Suture bag	25x33 cm	1	PE
30461E	Stockinette	30x122 cm	1	PP/PE
8475	Split drape, U adhesive 20x76 cm	152x213 cm	1	Blue PE
TB294320	Split drape, U adhesive 15x102 cm	196x254 cm	1	Trilaminate
TB29351	Head drape, reinforced	251x135 cm	1	Trilaminate
BTCL15	Back table cover, 50µm	125x230 cm	1	PP/PE

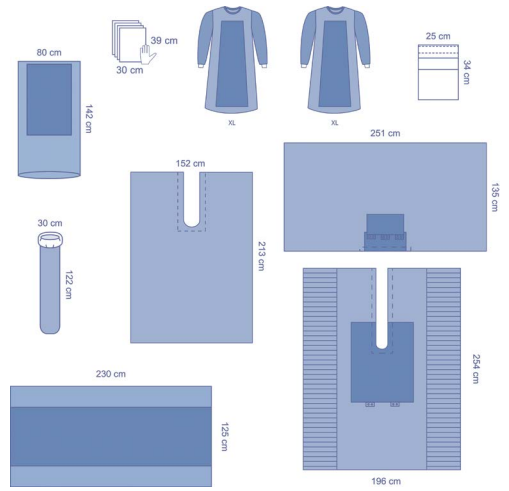

**DYJPEOPPSM3 –Orthopaedic split pack**

6 ea/cs

Component	Description	Size	Comp qty.	Material
MAYOM	Mayo stand cover	80x145 cm	1	PP/PE
HNTOM	Absorbent hand towel	34x36 cm	4	Cellulose
31363E	Stockinette	23x91 cm	1	PP/PE
15648EUR	Drape sheet	135x196 cm	1	wetlaid
TAPSM	Non-woven adhesive tape	10x50 cm	1	SMS
HEDSM1	Head drape, reinforced	300x183 cm	1	SMS
8270SM	Hip drape, with split fenestration 17x32 cm	196x285 cm	1	SMS

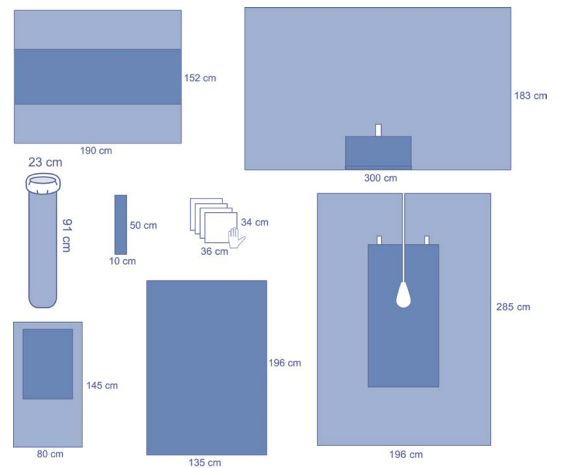

# TUR drapes and packs

## TB29361CE – TUR drape

10 ea/cs

Item order	Component	Size	Comp qty.	Material
1025B	Wrap		1	SMS
TB3958	TUR drape, adhesive fenestration 8x8 cm, with leggings	150/260x300 cm	1	Trilaminare

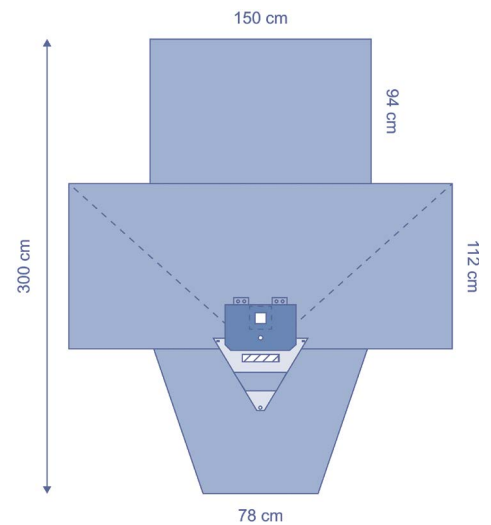

## ES29081CE – TUR pack

7 ea/cs

Item order	Component	Size	Comp qty.	Material
7471	Absorbent hand towel	20x30 cm	2	Cellulose
7014WP	Hook and loop tube holder	14x2.5 cm	1	Polyester
ZHE750	OP-tape	9x50 cm	1	Spunlace
ES46000	TUR drape, suprapubic fenestration 8 cm, lower fenestration 5 cm, finger cot	175/242x280 cm	1	Bilaminare
BTCM15	Back table cover, 50µm	140x190 cm	1	PP/PE
1025B	Wrap		1	SMS

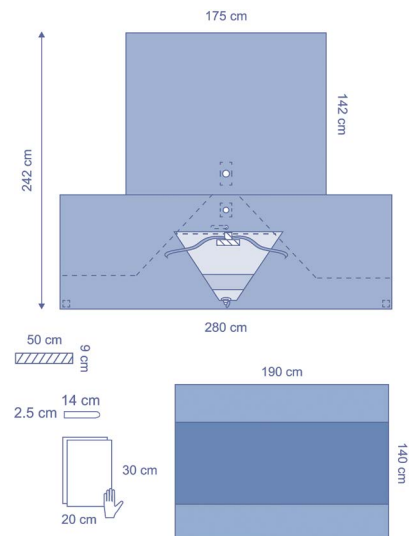

## ES10381CE – TUR pack

7 ea/cs

Item order	Component	Size	Comp qty.	Material
7471	Absorbent hand towel	20x30 cm	2	Cellulose
ZHE750	OP-tape	9x50 cm	1	Spunlace
ES45000	TUR drape, suprapubic fenestration 6 cm, lower fenestration 5 cm, finger cot	250/280x280 cm	1	Bilaminare
BTCM15	Back table cover, 50µm	140x190 cm	1	PP/PE
1025B	Wrap		1	SMS

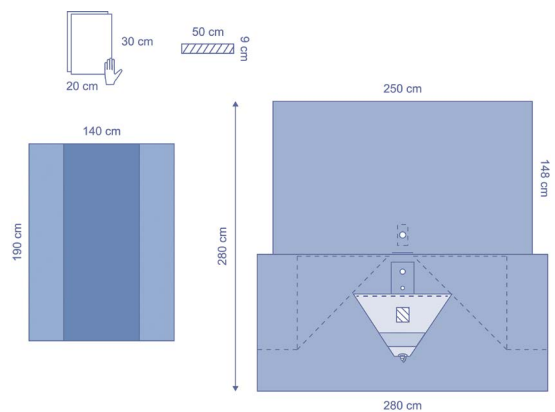

### TB29081CE – TUR pack

7 ea/cs

Item order	Component	Size	Comp qty.	Material
8520	Absorbent hand towel	39x58 cm	2	Cellulose
04A035	OP-tape	8x40 cm	1	PE
TB45000	TUR drape, suprapubic and lower fenestrations 6cm, finger cot	150/251x174 cm	1	Trilaminare
BTCM15	Back table cover, 50µm	140x190 cm	1	PP/PE
1025B	Wrap		1	SMS

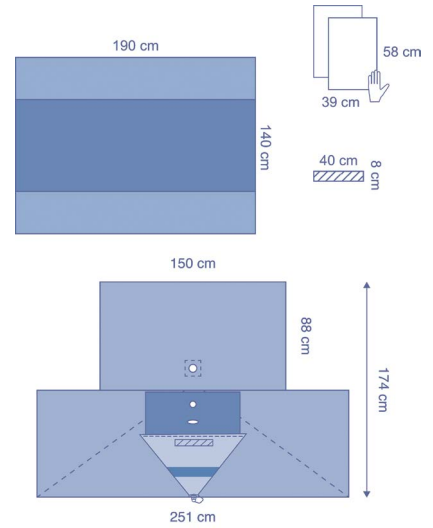

### TB277044CE – TUR pack

8 ea/cs

Item order	Component	Size	Comp qty.	Material
8339	Mayo stand cover	80x142 cm	1	PE
TB277044	TUR drape, suprapubic fenestration 3cm, lower fenestration 6 cm, finger cot, mesh screen filter 35x20 cm	150/310x250 cm	1	Trilaminare
BTCM15	Back table cover, 50µm	140x190 cm	1	PP/PE

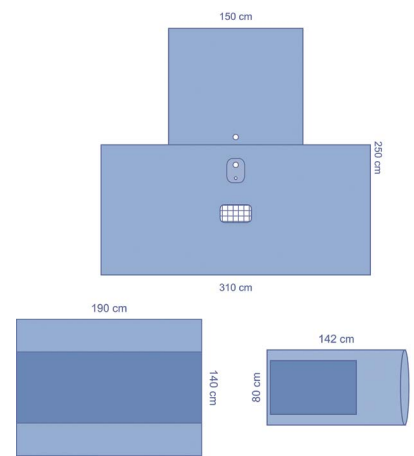

### TB27002CE – TUR pack

6 ea/cs

Item order	Component	Size	Comp qty.	Material
7471	Absorbent hand towel	20x30 cm	1	Cellulose
ZHE750BL	OP-tape	9x50 cm	2	PET/PE
TB27002	TUR drape, suprapubic fenestration 7x10 cm, lower fenestration 7x6 cm, finger cot, pouch with tubing	110/240x210 cm	1	Trilaminare
BTCM15	Back table cover, 50µm	140x190 cm	1	PP/PE

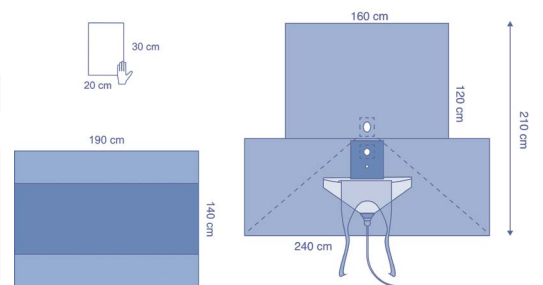

## DYJPETUPSM – TUR pack

7 ea/cs

Item order	Component	Size	Comp qty.	Material
HNTOM	Absorbent hand towel	34x36 cm	1	Cellulose
TUDSM	TUR drape, suprapubic fenestration 10x7 cm, lower fenestration 8x8 cm, finger cot	79/145x294 cm	1	SMS
TC060	Back table cover, 50µm	152x190 cm	1	PE

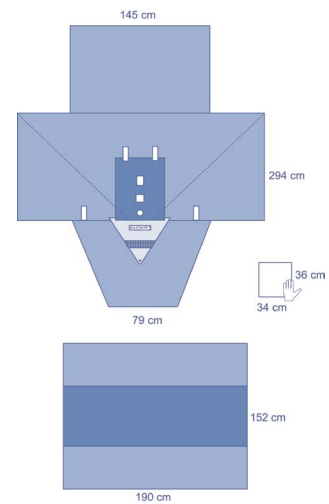

## CPE29011CE – TUR pack

4 ea/cs

Item order	Component	Size	Comp qty.	Material
S3540P	Essential OR gown, polyreinforced, MD/PPE	140 cm	1	SMS
8530	Absorbent hand towel	30x39 cm	8	Cellulose
IQ79041	Ultimate OR gown, impervious and breathable	XL, 140 cm	1	BVB
8339	Mayo stand cover	80x142 cm	1	PE
VC594	Camera cover	13x240 cm	1	PE
7023W	Hook and loop tube holder	2,5x23 cm	1	
ZHE750	OP-tape	9x50 cm	1	Spunlace
8483	Under-buttock drape with cuff	96x126 cm	1	PE
ES46000	TUR drape, suprapubic fenestration 8 cm, lower fenestration 5 cm, finger cot	175/242x280 cm	1	Bilaminare
BTCL25	Back table cover, 75µm	160x240 cm	1	PP/PE
1025B	Wrap		1	SMS

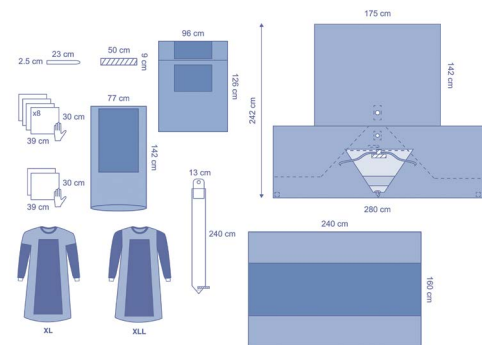

Scan the QR code to watch our draping instructions videos



# Lithotomy/cystoscopy packs

## ES10362CE – Basic gynecology pack

14 ea/cs

Item order	Component	Size	Comp qty.	Material
7471	Absorbent hand towel	20x30 cm	2	Cellulose
ZHE750	OP-tape	9x50 cm	1	Spunlace
ES02C212	Side drape	75x75 cm	2	Bilaminate
ES8420	Leggings	75x120 cm	2	Bilaminate
BTCM15	Back table cover, 50µm	140x190 cm	1	PP/PE
1025B	Wrap		1	SMS

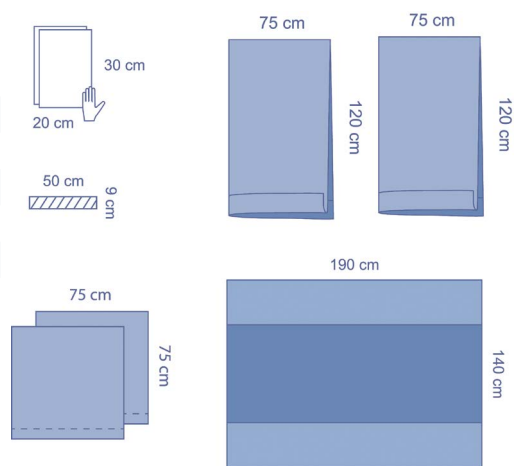

## ES9175CE – Basic gynecology pack

12 ea/cs

Item order	Component	Size	Comp qty.	Material
7471	Absorbent hand towel	20x30 cm	2	Cellulose
ES02C215	Adhesive drape	45x50 cm	1	Bilaminate
2491	Under-buttock drape with cuff	89x119 cm	1	PE </td
ES8420	Leggings	75x120 cm	2	Bilaminate
ES02C233	Drape sheet	120x150 cm	1	Bilaminate
BTCM15	Back table cover, 50µm	140x190 cm	1	PP/PE
1025B	Wrap		1	SMS

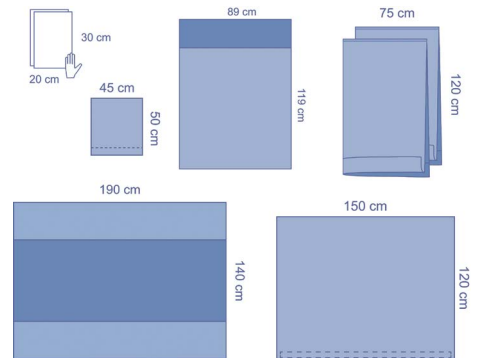

## TB9175CEA – Basic gynecology pack

10 ea/cs

Item order	Component	Size	Comp qty.	Material
ES02C215	Adhesive drape	45x50 cm	1	Bilaminate
8483	Under-buttock drape with cuff	96x126 cm	1	PE
8520	Absorbent hand towel	39x58 cm	1	Cellulose
8420	Leggings	79x140 cm	2	SMS
TB9359	Utility drape	98x145 cm	1	Trilaminare
BTCL15	Back table cover, 50µm	125x230 cm	1	PP/PE

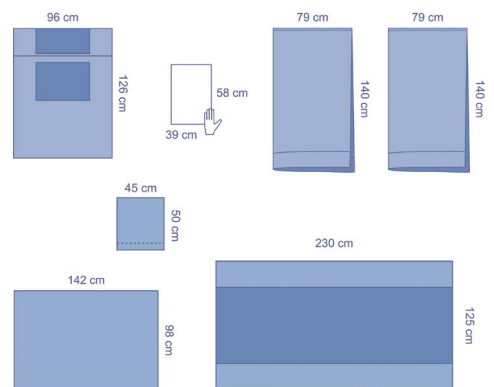

## ES15310CE – Cystoscopy pack

80 ea/cs

Item order	Component	Size	Comp qty.	Material
ES02C310	Cystoscopy drape, adhesive fenestration 6x12 cm, 2x16 cm cuts with adhesives	75x120 cm	1	Bilaminate
ES02C221	Drape sheet	75x90cm	1	Bilaminate

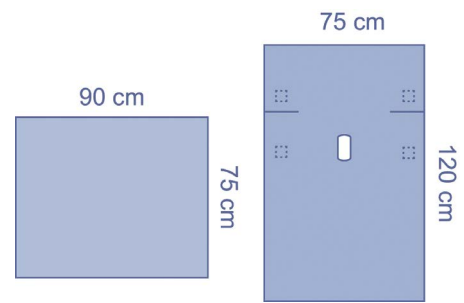

## ES10360CEA – Cystoscopy pack

17 ea/cs

Item order	Component	Size	Comp qty.	Material
7471	Absorbent hand towel	20x30 cm	2	Cellulose
8420	Leggings	79x140 cm	2	SMS
ES10451	Cystoscopy drape, adhesive fenestration 8x18 cm	120x75 cm	1	Bilaminate
BTCM15	Back table cover, 50µm	140x190 cm	1	PP/PE
1025B	Wrap		1	SMS

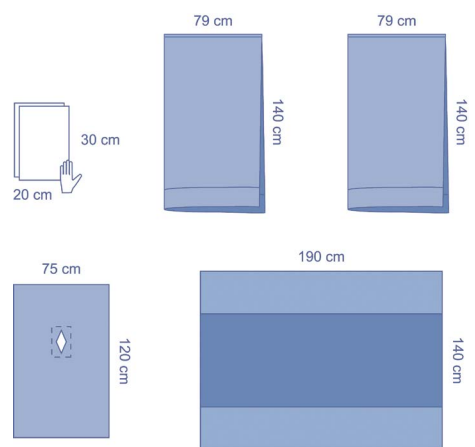

## ES10363CE – Cystoscopy pack

16 ea/cs

Item order	Component	Size	Comp qty.	Material
2490	Under-buttock drape	89x119 cm	1	PE
ES8420	Leggings	75x120 cm	2	Bilaminate
ES10804	Cystoscopy drape, fenestration 9x15 cm	170x75 cm	1	Bilaminate
BTCM15	Back table cover, 50µm	140x190 cm	1	PP/PE
1025B	Wrap		1	SMS

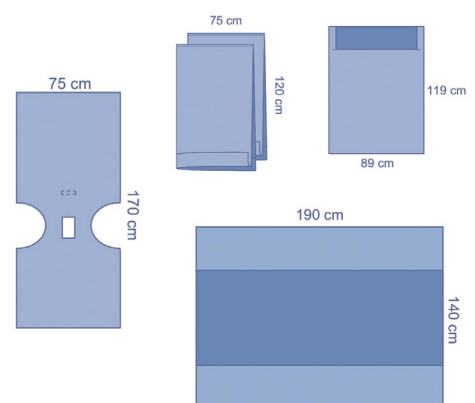

**TB29176CEA – Lithotomy pack**

10 ea/cs

Item order	Component	Size	Comp qty.	Material
ES02C215	Adhesive drape	45x50 cm	1	Bilaminate
8520	Absorbent hand towel	39x58 cm	1	Cellulose
8420	Leggings	79x140 cm	2	SMS
TBA29438	Lithotomy drape, adhesive fenestration 15x6 cm	137x192 cm	1	Trilaminare
BTCL15	Back table cover, 50µm	125x230 cm	1	PP/PE

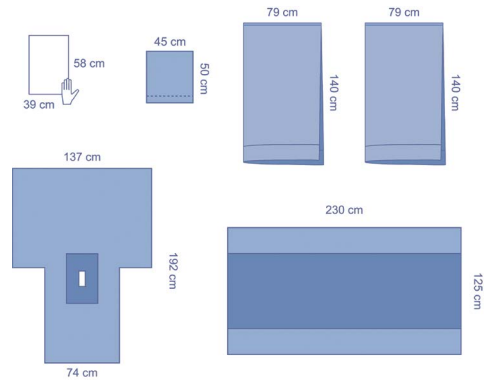

**TB29380CE – Lithotomy pack**

10 ea/cs

Item order	Component	Size	Comp qty.	Material
8520	Absorbent hand towel	39x58 cm	1	Cellulose
8420	Leggings	79x140 cm	2	SMS
TB29437	Cystoscopy drape, fenestration 8x15 cm, mesh screen 25x25 cm	98/163x232 cm	1	Trilaminare
BTCL15	Back table cover, 50µm	140x190 cm	1	PP/PE

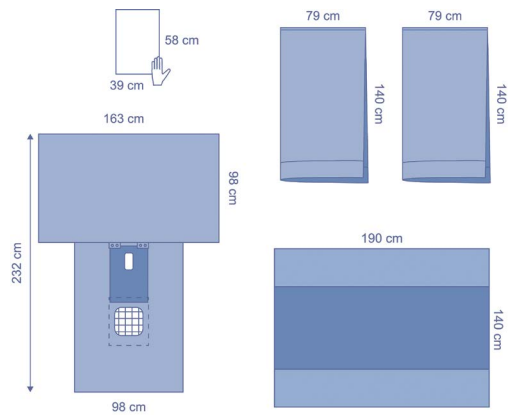



# All-in-one drapes and packs

## TB29360CE – Lithotomy pack

11 ea/cs

Component	Description	Size	Comp qty.	Raw material
8520	Absorbent hand towel	39x58 cm	1	Cellulose
TB29451	Urology drape, fenestration 8x15cm, mesh screen 36x20cm	89/262x220 cm	1	Trilaminare
BTCM15	Back table cover, 50µm	140x190 cm	1	PP/PE

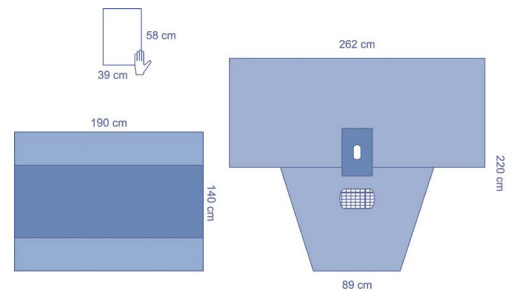

## TB29170CEA – Lithotomy pack

8 ea/cs

Item order	Component	Size	Comp qty.	Material
ES02C215	Adhesive drape	45x50 cm	1	Bilaminare
8483	Under-buttock drape with cuff	96x126 cm	1	PE
TBA29450	Lithotomy drape, adhesive fenestration 6x16cm, with leggings	89/229x312 cm	1	Trilaminare
8520	Absorbent hand towel	39x58 cm	1	Cellulose
BTCM15	Back table cover, 50µm	140x190 cm	1	PP/PE
1025B	Wrap		1	SMS

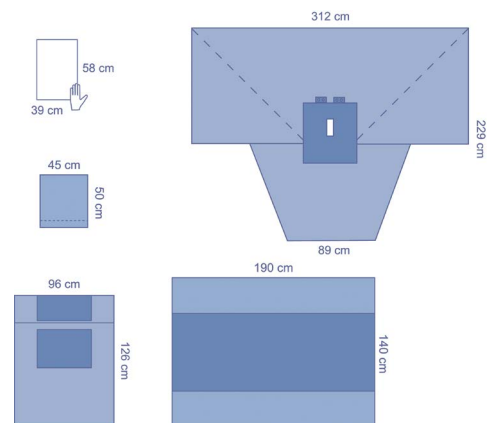

## TB29960CEA – Lithotomy pack

6 ea/cs

Item order	Component	Size	Comp qty.	Material
8520	Absorbent hand towel	39x58 cm	2	Cellulose
TB307554	Adhesive drape	49x65 cm	1	Trilaminare
8483	Under-buttock drape with cuff	96x126 cm	1	PE
TBA29450	Lithotomy drape, adhesive fenestration 6x16cm, with leggings	89/229x312 cm	1	Trilaminare
BTCM15	Back table cover, 50µm	140x190 cm	1	PP/PE

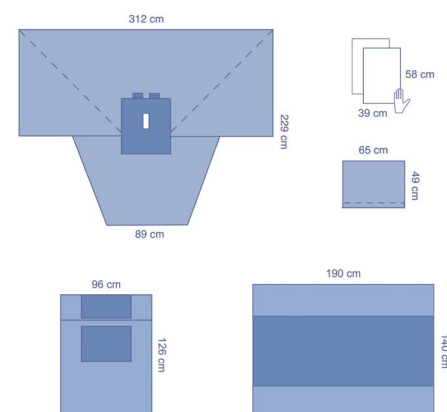

**ES10361CE – Gynecology pack**

8 ea/cs

Item order	Component	Size	Comp qty.	Material
7471	Absorbent hand towel	20x30 cm	2	Cellulose
8339	Mayo stand cover	80x142 cm	1	PE
ZHE750	OP-tape	9x50 cm	1	Spunlace
ES8009	Gynecology drape, heart shaped adhesive fenestration 9x12cm	35/40x114cm	1	Bilaminare
ES8008	Gynecology drape, adhesive fenestration 12x25 cm, with leggings	280x175/242cm	1	Bilaminare
BTCM15	Back table cover, 50µm	140x190 cm	1	PP/PE

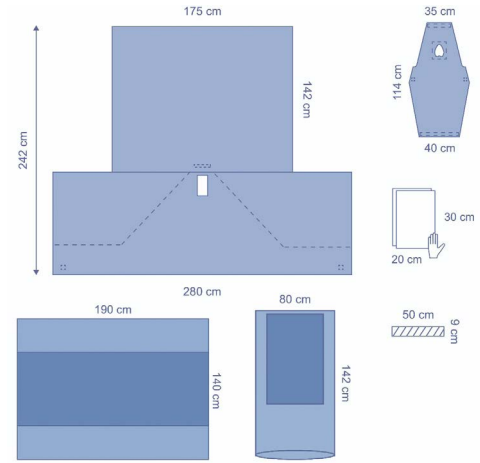

**TB27051CE – Gynecology pack**

6 ea/cs

Item order	Component	Size	Comp qty.	Material
7471	Absorbent hand towel	20x30 cm	1	Cellulose
8339	Mayo stand cover	80x142 cm	1	PE
7014WP	Hook and loop tube holder	14x2.5 cm	1	Polyester
8483	Under-buttock drape with cuff	96x126 cm	1	PE
TB30053	Adhesive drape	75x91 cm	1	Trilaminare
TB27051A	Gynecology drape, adhesive fenestration 10x11 cm	260/278x260 cm	1	Trilaminare
BTCM15	Back table cover, 50µm	140x190 cm	1	PP/PE

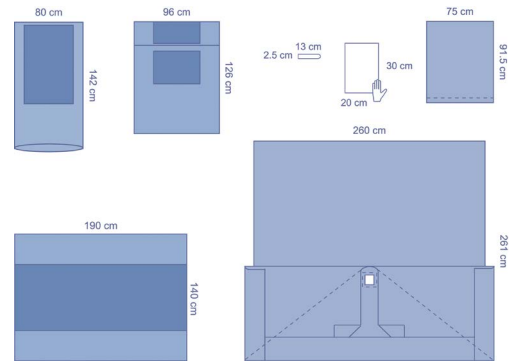

**29014CEA – Gynecology pack**

7 ea/cs

Item order	Component	Size	Comp qty.	Material
7471	Absorbent hand towel	20x30 cm	1	Cellulose
A29455	Lithotomy drape, adhesive fenestration 6x17 cm, with leggings	160/267x300 cm	1	Spunlace
BTCM15	Back table cover, 50µm	140x190 cm	1	PP/PE
1025B	Wrap		1	SMS

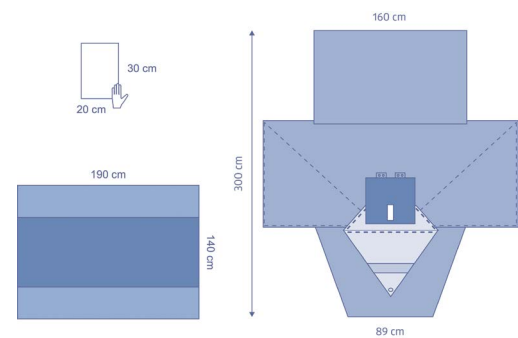

## ES10805CE – Gynecology pack

10 ea/cs

Item order	Component	Size	Comp qty.	Material
7471	Absorbent hand towel	20x30 cm	2	Cellulose
ZHE750	OP-tape	9x50 cm	1	Spunlace
ES02C221	Drape sheet	75x90cm	1	Bilaminate
ES47000	Gynecology drape, adhesive fenestration 10x17 cm	280/175 x 242 cm	1	Bilaminate
BTCM15	Back table cover, 50µm	140x190 cm	1	PP/PE
1025B	Wrap		1	SMS

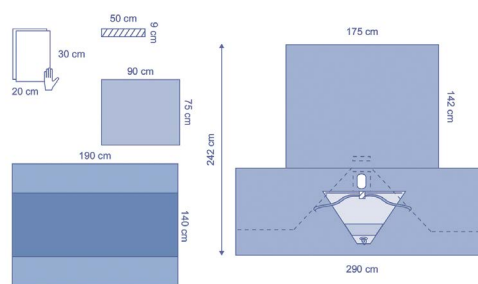

## CPU29010CE – Gynecology pack

8 ea/cs

Item order	Component	Size	Comp qty.	Material
8339	Mayo stand cover	80x142 cm	1	PE
8530	Absorbent hand towel	30x39 cm	4	Cellulose
8483	Under-buttock drape with cuff	96x126 cm	1	PE
04A036	Instrument pouch, 2 compartments	33x41 cm	1	Clear PE film
ZHE750	OP-tape	9x50 cm	2	Spunlace
7023W	Hook and loop tube holder	2,5x23 cm	1	
TBA29455	Lithotomy drape, adhesive fenestration 6x17 cm, with leggings	160/267x300 cm	1	Trilaminare
BTCL25	Back table cover, 75µm	160x240 cm	1	PP/PE
1025B	Wrap		1	SMS

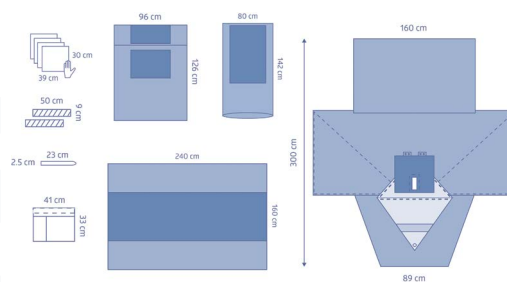

## ES10806CE – TVT pack

6 ea/cs

Item order	Component	Size	Comp qty.	Material
7471	Absorbent hand towel	20x30 cm	2	Cellulose
7014WP	Hook and loop tube holder	14x2.5 cm	1	Polyester
ZHE750	OP-tape	9x50 cm	1	Spunlace
8483	Under-buttock drape with cuff	96x126 cm	1	PE
ES8006	Gynecology TVT drape, adhesive fenestration 12x25 cm, with leggings	220/300x279cm	1	Bilaminate
BTCM15	Back table cover, 50µm	140x190 cm	1	PP/PE
1025B	Wrap		1	SMS

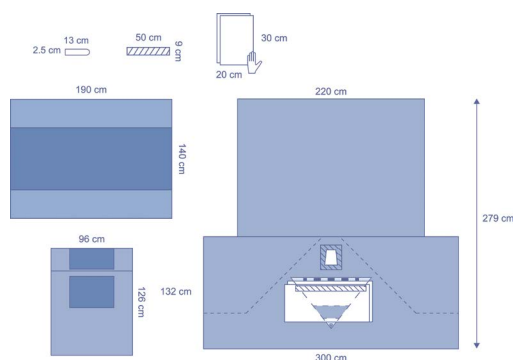

**SM8007CE – Gynecology pack**

10 ea/cs

Item order	Component	Size	Comp qty.	Material
8520	Absorbent hand towel	39x58 cm	1	Cellulose
SM8007	Gynecology drape, adhesive fenestration 22x41cm with incise film lower	80/255x289cm	1	SMS
BTCM15	Back table cover, 50µm	140x190 cm	1	PP/PE
1025B	Wrap		1	SMS

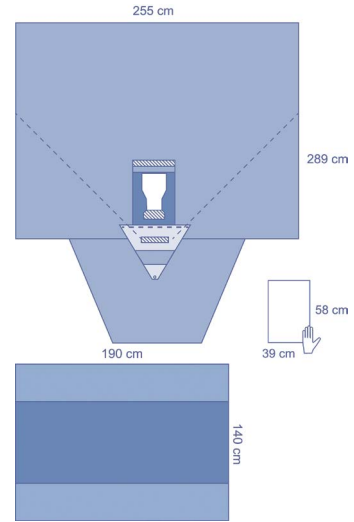

Scan the QR code to watch our draping instructions videos



# Delivery drapes and packs

## ES10311CE – Delivery pack

12 ea/cs

Item order	Component	Size	Comp qty.	Material
ZHE750	OP-tape	9x50 cm	1	Spunlace
7471	Absorbent hand towel	30x20 cm	2	Cellulose
ES02C212	Side drape	75x75 cm	1	Bilaminate
1001	Baby blanket	100x105 cm	1	Cellulose
ES8420	Leggings	75x120 cm	2	Bilaminate
45012	Under-buttock drape, with pouch	85x114 cm	1	PE
BTCM15	Back table cover, 50µm	140x190 cm	1	PP/PE
1025B	Wrap		1	SMS

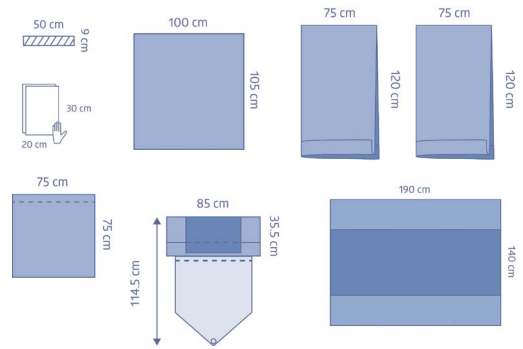

## ES10310CEB – Delivery pack with surgical gown

7 ea/cs

Item order	Component	Size	Comp qty.	Material
A75306	Baby blanket	100x105 cm	1	Spunlace
ES02C211	Adhesive drape	90x75 cm	1	Bilaminate
45012	Under-buttock drape, with pouch	85x114 cm	1	PE
8420	Leggings	79x140 cm	2	SMS
7471	Absorbent hand towel	30x20 cm	2	Cellulose
BTC515	Back table cover, 50µm	120x140 cm	1	PP/PE
1025B	Wrap		1	SMS

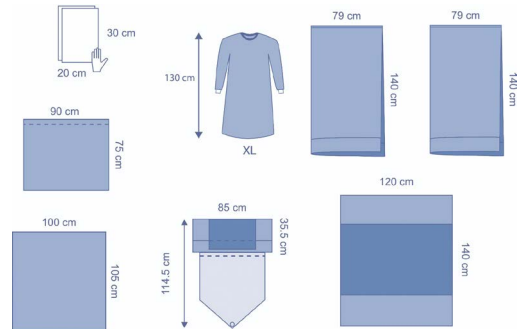

## CP29162CEA – Delivery pack with graduated pouch

7 ea/cs

Item order	Component	Size	Comp qty.	Material
8520	Absorbent hand towel	39x58 cm	2	Cellulose
OP9507	Advanced OR gown	XL, 140 cm	1	Soft-SMMMS
A75306	Baby blanket	100x105 cm	1	Spunlace
8484	Under-buttock drape with cuff, fluid collection pouch with graduations	96,5x118 cm	1	PE
8420	Leggings	79x140 cm	2	SMS
ES02C222	Drape sheet	75x75 cm	1	Bilaminate
S3545	Essential OR gown	XL, 130 cm	1	SMS
ES02C211	Adhesive drape	90x75 cm	1	Bilaminate
BTCM15	Back table cover, 50µm	140x190 cm	1	PP/PE

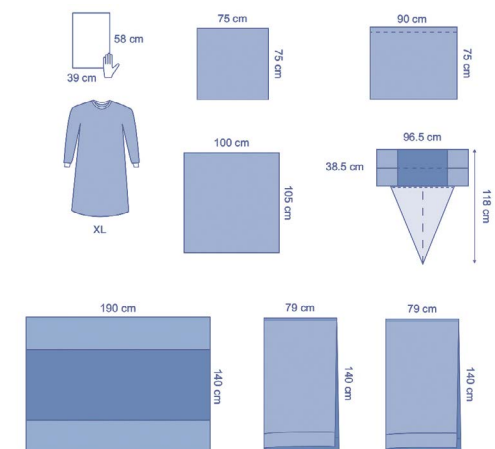

**ES10312CE – Delivery pack with double pouch** 16 ea/cs

Item order	Component	Size	Comp qty.	Material
ALNW307	Sponge swab, 4 ply, tied/10	10x10 cm	1	
ES02C221	Drape sheet	90x75 cm	1	Bilaminate
4576	Under-buttock drape, with 2 pouches and graduations	96x120 cm	1	PE
1001	Baby blanket	100x105 cm	1	Cellulose
7471	Absorbent hand towel	30x20 cm	2	Cellulose
BTCS15	Back table cover, 50µm	120x140 cm	1	PP/PE

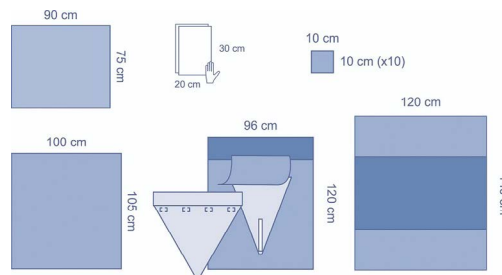

# C-section drapes and packs

**ES10851CE – C-section drape** 8 ea/cs

Item order	Component	Size	Comp qty.	Material
ES10851	Cesarean birth drape, adhesive fenestration 38x32 cm with incise film	190/260x311 cm	1	Bilaminate
1025B	Wrap		1	SMS

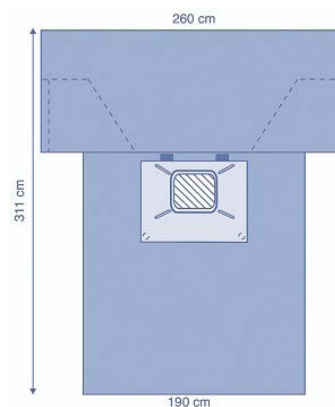

**ES10852CE – C-section drape** 8 ea/cs

Item order	Component	Size	Comp qty.	Material
ES10852	Cesarean birth drape, adhesive fenestration 38x32 cm, incise film with 17.5x18cm pear shape aperture	190/260x311 cm	1	Bilaminate
1025B	Wrap		1	SMS

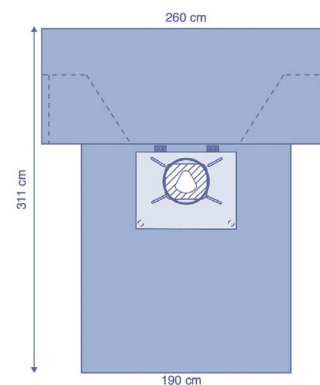

## ES10850CE – Skin-to-Skin c-section drape

6 ea/cs

Item order	Component	Size	Comp qty.	Material
ES10850	Gentle cesarean birth drape with Skin-to-Skin tunnel, adhesive fenestration 38x30 cm, incise film with 17.5x18cm pear shape aperture	196/240x307 cm	1	Bilaminate
1025B	Wrap		1	SMS

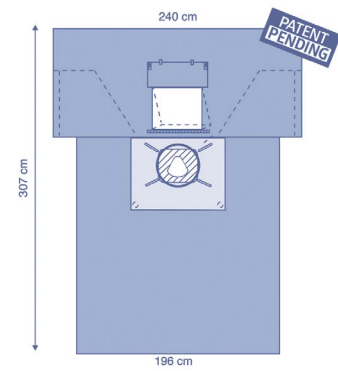

## TB29452CE – C-section drape

12 ea/cs

Item order	Component	Size	Comp qty.	Material
TB29452	Cesarean birth drape, adhesive fenestration 30x36 cm, incise film with 17.5x18cm pear shape aperture	196/249x300 cm	1	Trilaminare
1025B	Wrap		1	SMS

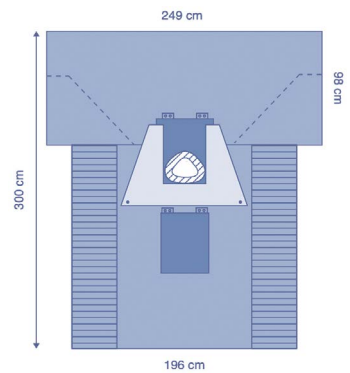

## TB29446CE – C-section pack

10 ea/cs

Item order	Component	Size	Comp qty.	Material
TB29446	Cesarean birth drape, adhesive fenestration 30x36 cm with incise film	196/249x314 cm	1	Trilaminare
1025B	Wrap		1	SMS

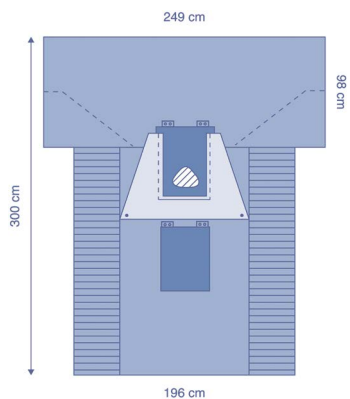

### DYNJPE6102SM – C-section drape

7 ea/cs

Item order	Component	Size	Comp qty.	Material
2640SM	Cesarean birth drape, fenestration 43x38 cm, incise film with 17,5x17,5 cm pear shaped aperture	196/259x307 cm	1	SMS
1025B	Wrap		1	SMS

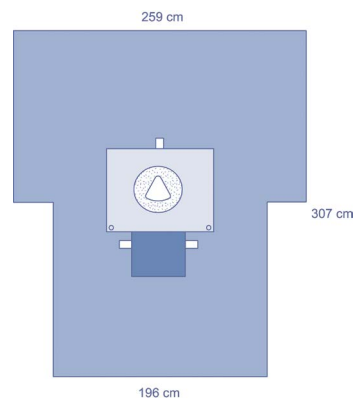

### ES10856CE – C-section pack

6 ea/cs

Item order	Component	Size	Comp qty.	Material
7471	Absorbent hand towel	30x20 cm	4	Cellulose
ZHE750	OP-tape	9x50 cm	2	Spunlace
1001	Baby blanket	100x105 cm	1	Cellulose
BTCS16	Back table cover, 50µm	140x120 cm	1	PP/PE
ES10852	Cesarean birth drape, adhesive fenestration 38x32 cm, incise film with 17.5x18cm pear shape aperture	190/260x311 cm	1	Bilaminate
BTCM15	Back table cover, 50µm	140x190 cm	1	PP/PE
1025B	Wrap		1	SMS

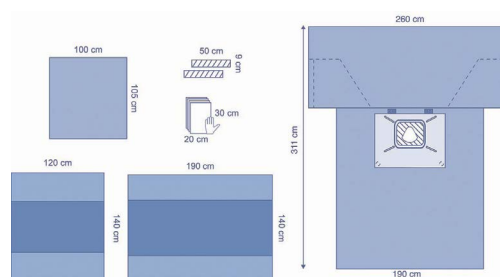

### ES10857CE – C-section pack

6 ea/cs

Item order	Component	Size	Comp qty.	Material
7471	Absorbent hand towel	30x20 cm	4	Cellulose
ZHE750	OP-tape	9x50 cm	2	Spunlace
1001	Baby blanket	100x105 cm	1	Cellulose
BTCS16	Back table cover, 50µm	140x120 cm	1	PP/PE
ES10851	Cesarean birth drape, adhesive fenestration 38x32 cm with incise film	190/260x311 cm	1	Bilaminate
BTCM15	Back table cover, 50µm	140x190 cm	1	PP/PE
1025B	Wrap		1	SMS

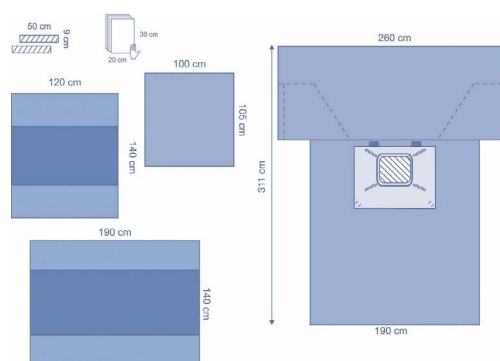



## ES29445CE – C-section pack

5 ea/cs

Item order	Component	Size	Comp qty.	Material
8339	Mayo stand cover	80x142 cm	1	PE
7471	Absorbent hand towel	30x20 cm	4	Cellulose
04A040	Instrument pouch, 2 compartments	33x51cm	1	PE
1001	Baby blanket	100x105 cm	1	Cellulose
ES29448	Cesarean birth drape, adhesive fenestration 47x32 cm with incise film	196/259x314 cm	1	Bilaminare
BTCM15	Back table cover, 50µm	140x190 cm	1	PP/PE

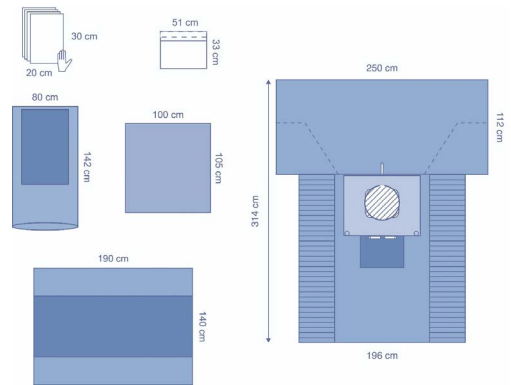

## TB29194CE – C-section pack

6 ea/cs

Item order	Component	Size	Comp qty.	Material
04A035	OP-tape	8x40 cm	1	PE
BTC516	Back table cover, 50µm	140x120 cm	1	PP/PE
7471	Absorbent hand towel	30x20 cm	2	Cellulose
TB29452	Cesarean birth drape, adhesive fenestration 30x36 cm, incise film with 17.5x18cm pear shape aperture	196/249x300 cm	1	Trilaminare
A75306	Baby blanket	100x105 cm	1	Spunlace
BTCM15	Back table cover, 50µm	140x190 cm	1	PP/PE
1025B	Wrap		1	SMS

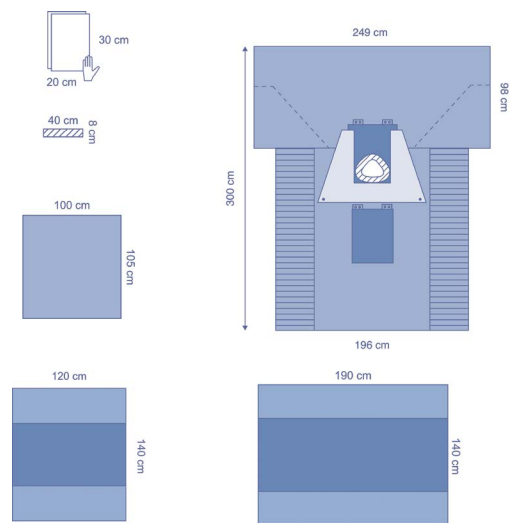

## CP29045CE – C-section pack

5 ea/cs

Item order	Component	Size	Comp qty.	Material
8520	Absorbent hand towel	39x58 cm	2	Cellulose
A75306	Baby blanket	100x105 cm	1	ECL - Spunlace
BTCM26	Back table cover, 75µm, folded	140x190 cm	1	PP/PE
TB29448	Cesarean birth drape, adhesive fenestration 36x30 cm with incise film	196/249x314 cm	1	Trilaminare
BTCM15	Back table cover, 50µm	140x190 cm	1	PP/PE
1025B	Wrap		1	SMS

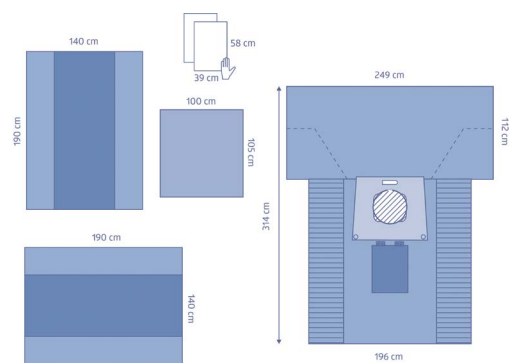

**TB29453CE – C-section pack**

6 ea/cs

Item order	Component	Size	Comp qty.	Material
7471	Absorbent hand towel	30x20 cm	2	Cellulose
8339	Mayo stand cover	80x142 cm	1	PE
TB29452	Cesarean birth drape, adhesive fenestration 30x36 cm, incise film with 17.5x18cm pear shape aperture	196/249x300 cm	1	Trilaminate
A75306	Baby blanket	100x105 cm	1	Spunlace
BTCM15	Back table cover, 50µm	140x190 cm	1	PP/PE

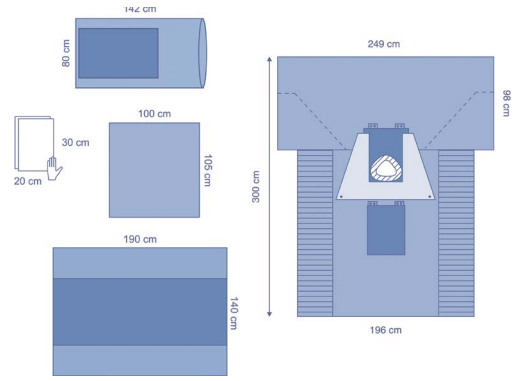

# Dental

## TB29004CE – Dental drape

36 ea/cs

Item order	Component	Size	Comp qty.	Material
TB8003	Jaw drape, fenestration 15x11cm	95x145 cm	1	Trilaminate

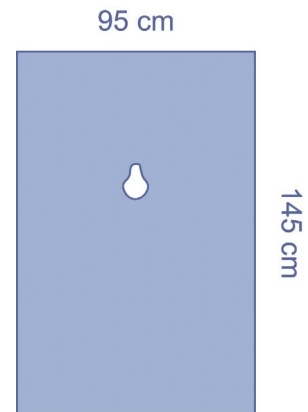

# ENT

## TB29422CE – Thyroid drape

12 ea/cs

Item order	Component	Size	Comp qty.	Material
TB29422	Thyroid drape, adhesive diamond fenestration 13x13cm	196x311 cm	1	Trilaminate
1025B	Wrap		1	SMS

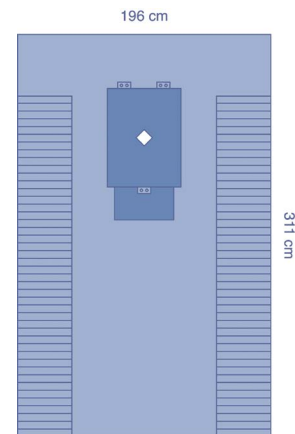

## TB29522CE – Thyroid pack

10 ea/cs

Item order	Component	Size	Comp qty.	Material
TB29522	Thyroid drape, adhesive diamond fenestration 13x13cm	196/269X309 cm	1	Trilaminate
BTCM15	Back table cover, 50µm	140x190 cm	1	PP/PE

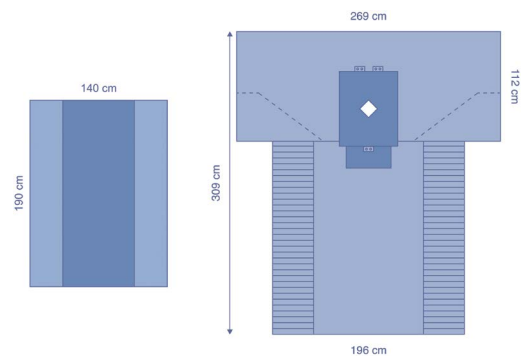

### TB277041CE – Thyroid pack

6 ea/cs

Item order	Component	Size	Comp qty.	Material
8339	Mayo stand cover	80x142 cm	1	PP/PE
TB277020	Split thyroid drape, adhesive, head side	240x145 cm	1	Trilaminare
TB277021	Split thyroid drape, adhesive, foot side	183x240 cm	1	Trilaminare
BTCM15	Back table cover, 50µm	140x190 cm	1	PP/PE

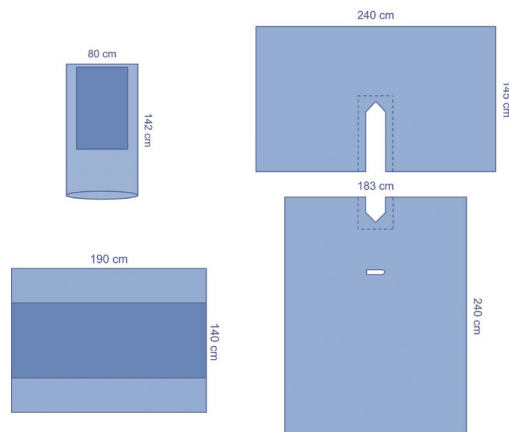

### 29670CEA – ENT drape

34 ea/cs

Item order	Component	Size	Comp qty.	Material
29670	Aperture drape, reinforced, adhesive fenestration 6 cm diameter	150x196 cm	1	Spunlace
1025B	Wrap		1	SMS

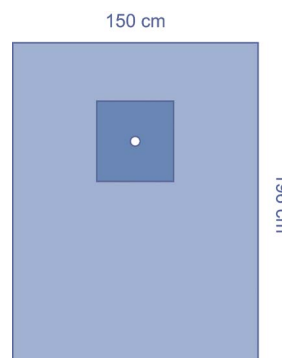

### 29232CEA – ENT pack

16 ea/cs

Item order	Component	Size	Comp qty.	Material
7471	Absorbent hand towel	20x30 cm	1	Cellulose
7014WP	Hook and loop tube holder	14x2.5 cm	1	Polyester
29670	Aperture drape, reinforced, adhesive fenestration 6 cm diameter	150x196 cm	1	Spunlace
BTCM15	Back table cover, 50µm	140x190 cm	1	PP/PE
1025B	Wrap		1	SMS

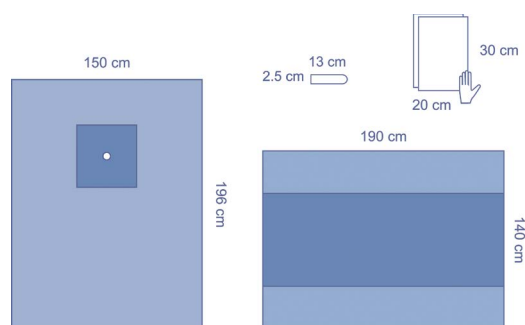

## ES39450CE – Ear pack

14 ea/cs

Item order	Component	Size	Comp qty.	Material
ZHE750	OP-tape	9x50 cm	2	Spunlace
ES39451	ENT drape, fenestration with opened incise film	180x250 cm	1	Bilaminate
BTCM15	Back table cover, 50µm	140x190 cm	1	PP/PE
1025B	Wrap		1	SMS

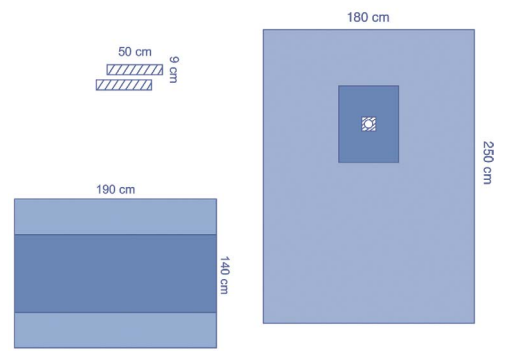

## TB39450CE – ENT pack

12 ea/cs

Item order	Component	Size	Comp qty.	Material
14804-6	Incise film, fenestration 5 cm	13 x 16,5 cm	1	Polyoxymethylene
7471	Absorbent hand towel	20x30 cm	2	Cellulose
TB39450	ENT drape, adhesive fenestration 12 x 7 cm	270x196 cm	1	Trilaminare
BTCM15	Back table cover, 50µm	140x190 cm	1	PP/PE
1025B	Wrap		1	SMS

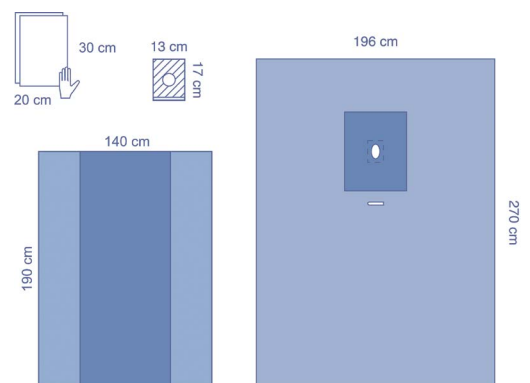

## CP39250CE – Plastic surgery pack

14 ea/cs

Item order	Component	Size	Comp qty.	Material
8530	Absorbent hand towel	30x39 cm	2	Cellulose
AL009	Swabs, woven, 12 ply, 17 threads	10x10 cm	16	Cotton
F2956	ENT drape, adhesive fenestration 13x17 cm	145 x 145cm	1	Spunlace
BTCS15	Back table cover, 50µm	120x140 cm	1	PP/PE
1025B	Wrap		1	SMS

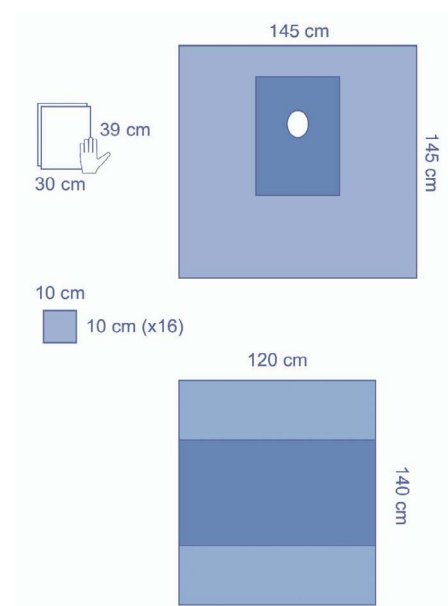

### ES30460CE – ENT pack

10 ea/cs

Item order	Component	Size	Comp qty.	Material
MAYOM	Mayo stand cover	80x145 cm	2	PP/PE
04A035	OP-tape	8x40 cm	1	PE
ES30459	ENT drape, adhesive fenestration 12x16 cm	228x300 cm	1	Bilaminate
BTCM15	Back table cover, 50µm	140x190 cm	1	PP/PE

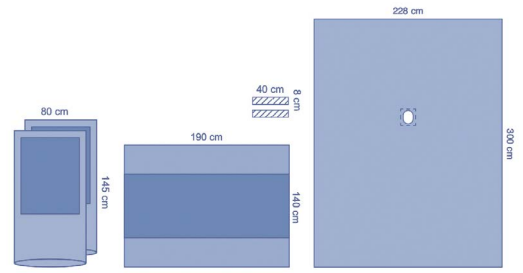

### TB30460CE – ENT pack

10 ea/cs

Item order	Component	Size	Comp qty.	Material
7471	Absorbent hand towel	20x30 cm	4	Cellulose
ZHE750	OP-tape	9x50 cm	1	Spunlace
8339	Mayo stand cover	80x142 cm	1	PP/PE
TB30663	ENT drape, adhesive fenestration 12.5x15 cm	196x300 cm	1	Trilaminare
BTCM15	Back table cover, 50µm	140x190 cm	1	PP/PE

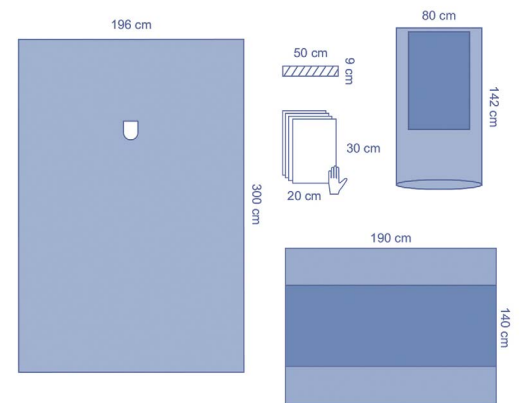

### TB291060CE – ENT pack

6 ea/cs

Item order	Component	Size	Comp qty.	Material
9516	OR gown, Eclipse, XLL	150 cm	1	Spunlace
8339	Mayo stand cover	80x142 cm	1	PP/PE
ZHE750	OP-tape	9x50 cm	1	Spunlace
TB30663	ENT drape, adhesive fenestration 12.5x15 cm	196x300 cm	1	Trilaminare
BTCM15	Back table cover, 50µm	140x190 cm	1	PP/PE

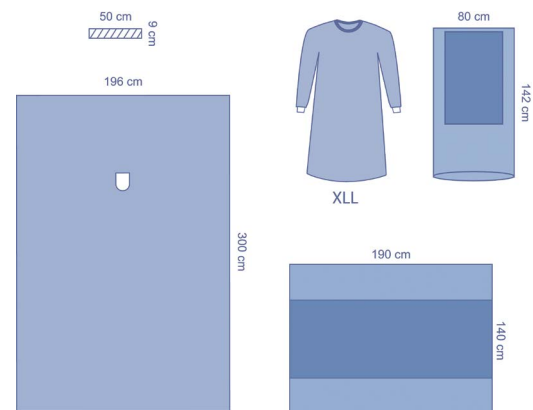

## ES10914CE – ENT pack

12 ea/cs

Item order	Component	Size	Comp qty.	Material
ZHE750	OP-tape	9x50 cm	1	Spunlace
ES02C236	Drape sheet	100x120 cm	2	Bilaminate
ES11602	Foot drape	190x200 cm	1	Bilaminate
BTCM15	Back table cover, 50µm	140x190 cm	1	PP/PE

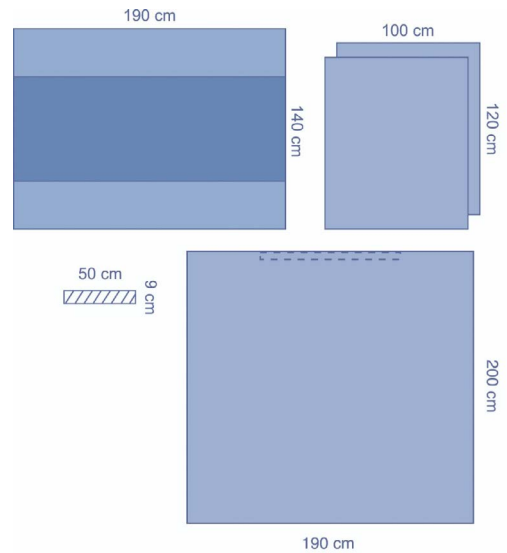

## 9193CEA – ENT pack

15 ea/cs

Item order	Component	Size	Comp qty.	Material
ZHE750	OP-tape	9x50 cm	1	Spunlace
9559	Drape sheet	145x193 cm	1	Spunlace
9558	Drape sheets	112x147 cm + 112x112 cm	1	Spunlace
1025B	Wrap		1	SMS

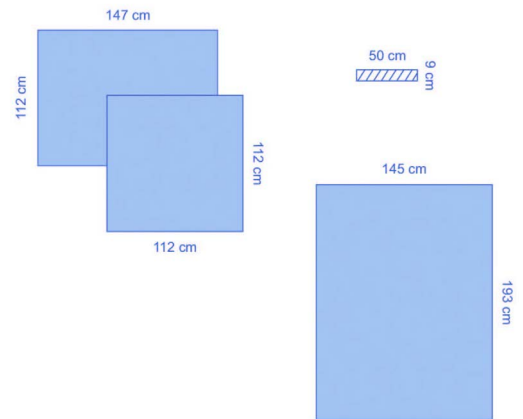

## TB9556CE – Head & neck drape

32 ea/cs

Item order	Component	Size	Comp qty.	Material
TB9556	Head bar drape, adhesive	86x107 cm	1	Trilaminate
1025B	Wrap		1	SMS

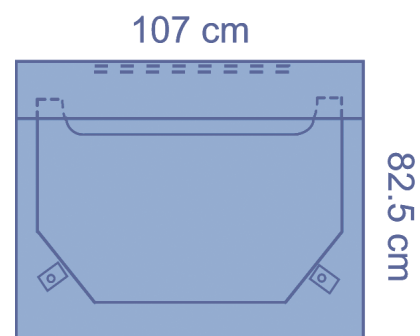

### ES9193CE – Head & neck pack

10 ea/cs

Item order	Component	Size	Comp qty.	Material
7471	Absorbent hand towel	20x30 cm	2	Cellulose
8339	Mayo stand cover	80x142 cm	1	PP/PE
ES9556	Head turban drape	85x110 cm	1	Bilaminate
ES9442	Split drape, U adhesive 6x64 cm	198x280 cm	1	Bilaminate
BTCM15	Back table cover, 50µm	140x190 cm	1	PP/PE
1025B	Wrap		1	SMS

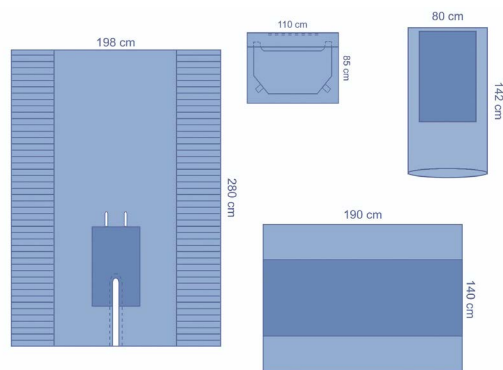

### TB9192CE – Head & neck pack

10 ea/cs

Item order	Component	Size	Comp qty.	Material
8339	Mayo stand cover	80x142 cm	1	PP/PE
TB9556	Head bar drape, adhesive	86x107 cm	1	Trilaminate
TB9442	Split drape, U adhesive 6x64 cm	196x279 cm	1	Trilaminate
BTCM15	Back table cover, 50µm	140x190 cm	1	PP/PE

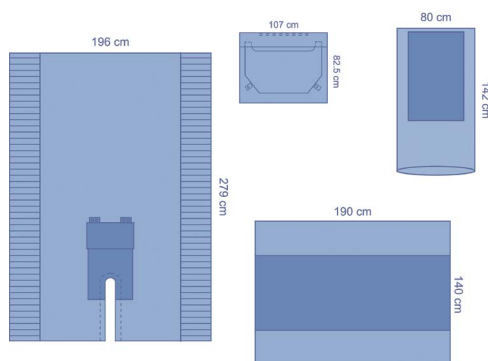

### ES9195CEA – Head & neck pack

12 ea/cs

Item order	Component	Size	Comp qty.	Material
7471	Absorbent hand towel	20x30 cm	2	Cellulose
8339	Mayo stand cover	80x142 cm	1	PP/PE
ES29444	Adhesive drape, reinforced	110x95 cm	1	Bilaminate
ES9195	Split drape, U adhesive 6x55 cm	200x290 cm	1	Bilaminate
BTCM15	Back table cover, 50µm	140x190 cm	1	PP/PE

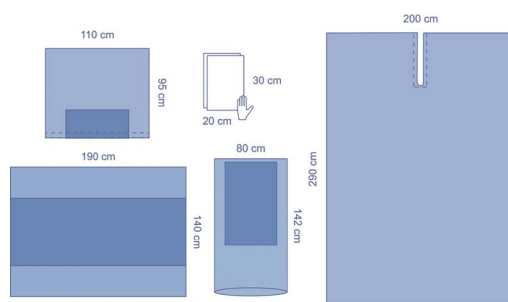



**CP29036CE – Head & neck pack**

9 ea/cs

Item order	Component	Size	Comp qty.	Material
8339	Mayo stand cover	80x142 cm	1	PP/PE
7014WP	Hook and loop tube holder	14x2.5 cm	1	Polyester
TB31300	Adhesive drape	75x98 cm	1	Trilaminate
TB29423	Split drape, U adhesive 6x94 cm	196 x 275 cm	1	Trilaminate
BTCM15	Back table cover, 50µm	140x190 cm	1	PP/PE

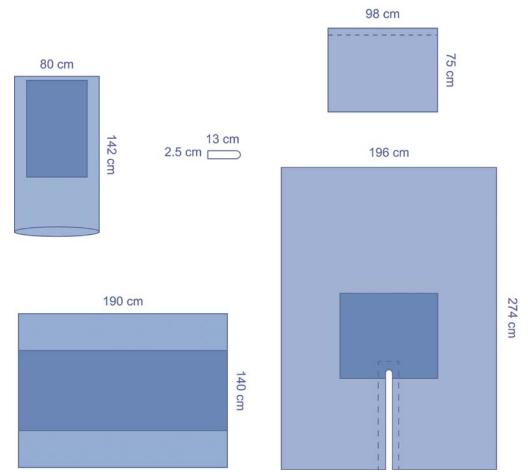

Scan the QR code to watch our draping instructions videos



# Ophthalmology

## S8441CE – Ophthalmic drape

60 ea/cs

Item order	Component	Size	Comp qty.	Material
S8441	Ophthalmic drape, adhesive fenestration 7x4,5 cm, unfolding on eye	112x157 cm	1	SMS
1025B	Wrap		1	SMS

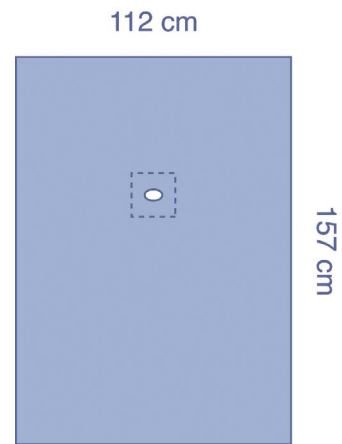

## IDE1061 – Clear ophthalmic drape

40 ea/cs

Item order	Component	Size	Comp qty.	Material
IDE1061	Ophthalmic drape with pouch, fenestration 12.5x11.5 cm with full incise film, unfolding on eye	122x129 cm	1	Clear PE

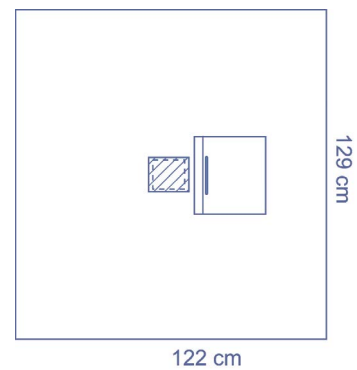

## IDE1062 – Ophthalmic drape

10 ea/cs

Item order	Component	Size	Comp qty.	Material
IDE1062	Ophthalmic drape with pouch, fenestration 13x11.5 cm with full incise film, unfolding on eye	122x129 cm	1	SMS

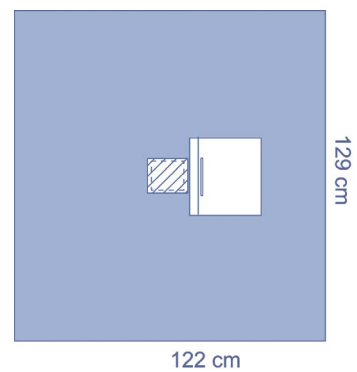

**S7444CE** – Ophthalmic drape

34 ea/cs

Item order	Component	Size	Comp qty.	Material
S7444	Ophthalmic drape with 2 side pouches, full incise film, unfolding on eye	122x158 cm	1	SMS
1025B	Wrap		1	SMS

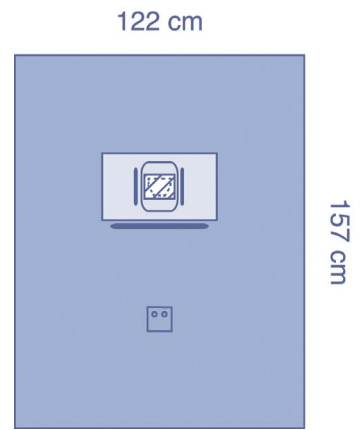

**S7445CE** – Ophthalmic drape

34 ea/cs

Item order	Component	Size	Comp qty.	Material
S7445	Ophthalmic drape with 2 side pouches, incise film with 6x4 cm aperture, unfolding on eye	122x158 cm	1	SMS
1025B	Wrap		1	SMS

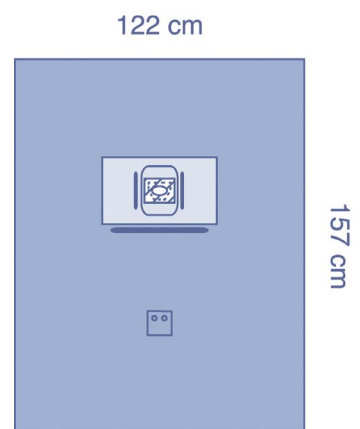

**S9563CE** – Ophthalmic drape

24 ea/cs

Item order	Component	Size	Comp qty.	Material
S9563	Ophthalmic drape with 2 side pouches, incise film with 6x4 cm aperture, unfolding on abdomen	183x157 cm	1	SMS
1025B	Wrap		1	SMS

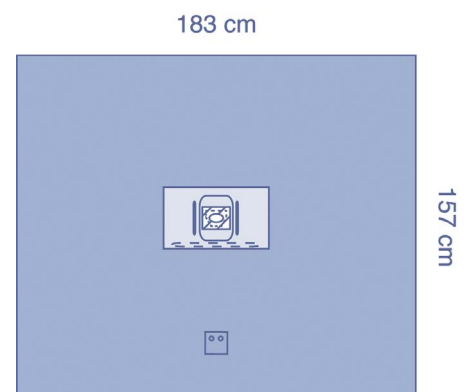

### S9562CE – Ophtalmic drape

20 ea/cs

Item order	Component	Size	Comp qty.	Material
S9562	Ophtalmic drape with 2 pouches, incise film with 6x4 cm aperture, additional incise film 13x10cm, unfolding on abdomen	191x279 cm	1	SMS
1025B	Wrap		1	SMS

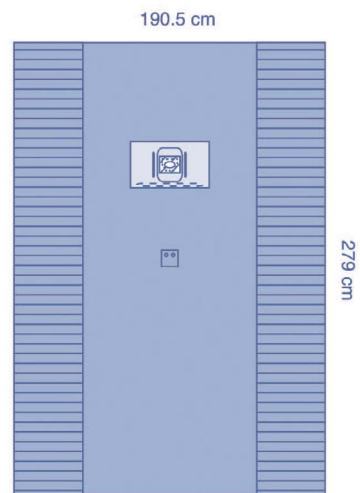

### TB9562CE – Ophtalmic drape

16 ea/cs

Item order	Component	Size	Comp qty.	Material
TB9562	Ophtalmic drape with 2 pouches, incise film with 6x4 cm aperture, additional incise film 13x10cm, unfolding on abdomen	196x279 cm	1	Trilaminate
1025B	Wrap		1	SMS

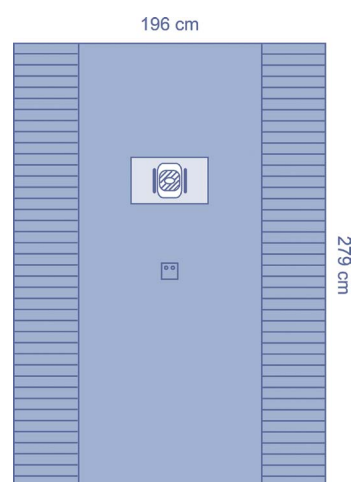

### DYNJPE7004 – Ophtalmic drape

10 ea/cs

Item order	Component	Size	Comp qty.	Material
E29676	Ophtalmic drape with 2 side pouches, full incise film, unfolding on eye	165x178 cm	1	Wetlaid
1025B	Wrap		1	SMS

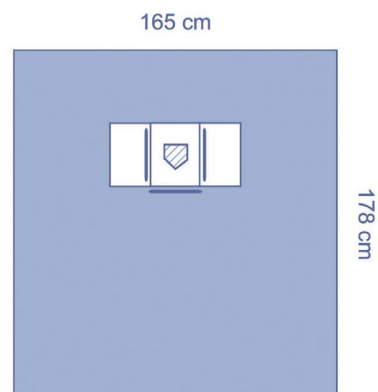

### DYNJPE7005 – Ophtalmic drape

10 ea/cs

Item order	Component	Size	Comp qty.	Material
E29677	Ophtalmic drape with 2 pouches, incise film with 6x4 cm aperture, unfolding on eye	165x178 cm	1	Wetlaid
1025B	Wrap		1	SMS

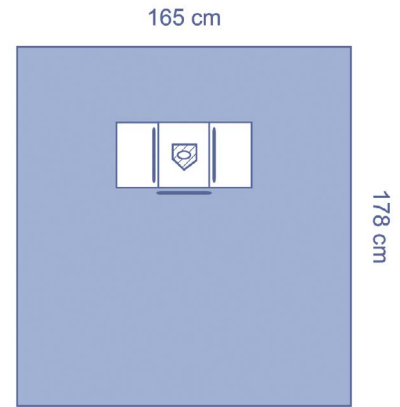

### CP30458CE – Strabismus pack

20 ea/cs

Item order	Component	Size	Comp qty.	Material
8520	Absorbent hand towel	39x58 cm	2	Cellulose
F80457	Ophtalmic drape, adhesive fenestration 17x7cm	110x240 cm	1	Trilaminare
BTCM15	Back table cover, 50µm	140x190 cm	1	PP/PE
1025B	Wrap		1	SMS

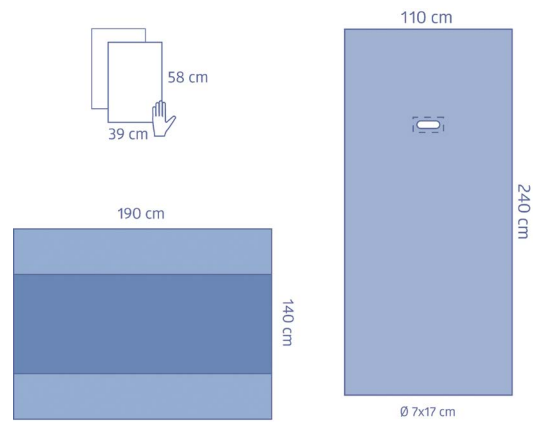

### CP95622CE – Ophtalmic pack

16 ea/cs

Item order	Component	Size	Comp qty.	Material
S9563	Ophtalmic drape with 2 sides pouch, incise film with 6x4 cm aperture, unfolding on abdomen	183x157 cm	1	SMS
BTCM15	Back table cover, 50µm	140x190 cm	1	PP/PE
1025B	Wrap		1	SMS

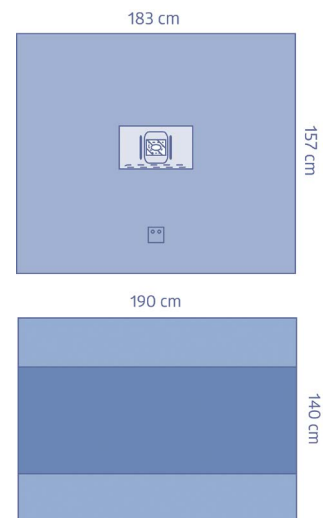

### DYJPEOPHPSM1 – Ophthalmic pack

12 ea/cs

Item order	Component	Size	Comp qty.	Material
E29676SM	Ophthalmic drape with 2 pouches, incise film with 6x4 cm aperture, unfolding on eye	165x178 cm	1	SMS
BTCM15	Back table cover, 50µm	140x190 cm	1	PP/PE
1025B	Wrap		1	SMS

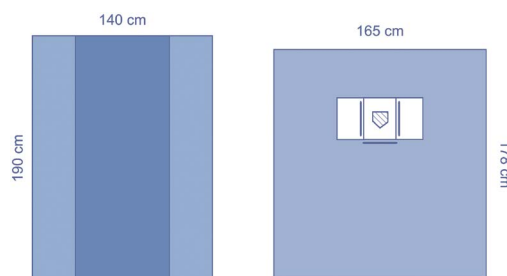

### DYJPEOPHPSM2 – Ophthalmic pack

12 ea/cs

Item order	Component	Size	Comp qty.	Material
E29677SM	Ophthalmic drape with 2 pouches, full incise film, unfolding on eye	165x178 cm	1	SMS
BTCM15	Back table cover, 50µm	140x190 cm	1	PP/PE
1025B	Wrap		1	SMS

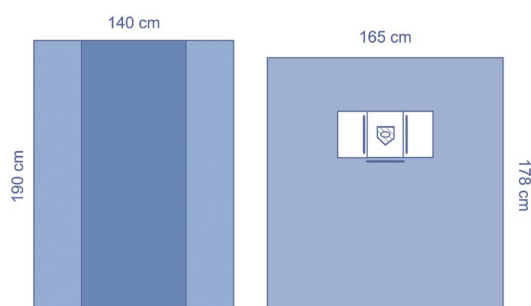

### DYJPEOPHPSM3 – Ophthalmic pack

15 ea/cs

Item order	Component	Size	Comp qty.	Material
E29677SM	Ophthalmic drape with 2 pouches, full incise film, unfolding on eye	165x178 cm	1	SMS
TC001	Back table cover, 50µm	110x112 cm	1	PP/PE
1025B	Wrap		1	SMS

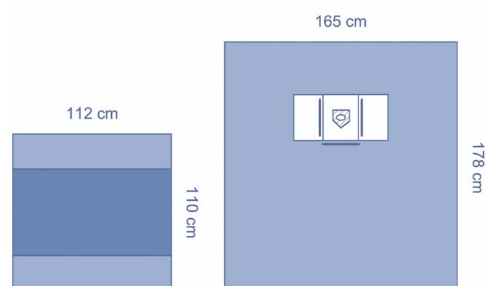

## TB25621CEA – Ophthalmic pack

16 ea/cs

Item order	Component	Size	Comp qty.	Material
TB9561	Ophthalmic drape with 2 pouches, incise film with 6x4 cm aperture, additional incise film 12x15 cm, unfolding on eye	196x279cm	1	Trilaminate
BTCM15	Back table cover, 50µm	140x190 cm	1	PP/PE
1025B	Wrap		1	SMS

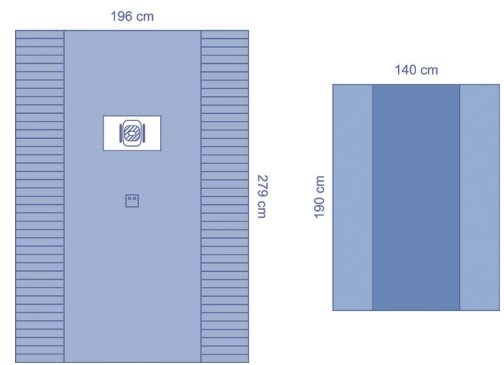

## CP29117CE – Ophthalmic pack

5 ea/cs

Item order	Component	Size	Comp qty.	Material
8520	Absorbent hand towel	39x58 cm	2	Cellulose
S3506	Essential OR gown	L, 120 cm	1	SMS
S3545	Essential OR gown	XL, 130 cm	2	SMS
TB9562	Ophthalmic drape with 2 pouches, incise film with 6x4 cm aperture, additional incise film 15x13 cm, unfolding on abdomen	196x279 cm	1	Trilaminate
BTCM15	Back table cover, 50µm	140x190 cm	1	PP/PE

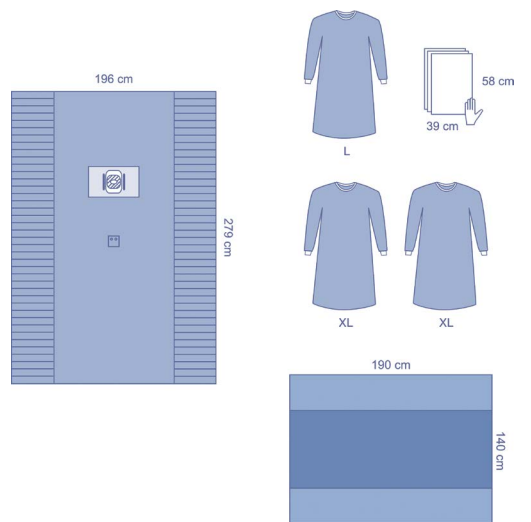

# Neurosurgery

## TB29418CE – Spine drape

7 ea/cs

Item order	Component	Size	Comp qty.	Material
TB29418	Spine drape, reinforced, adhesive fenestration 10x30cm, 2 instrument pouches	251/284x343 cm	1	Trilaminare
1025B	Wrap		1	SMS

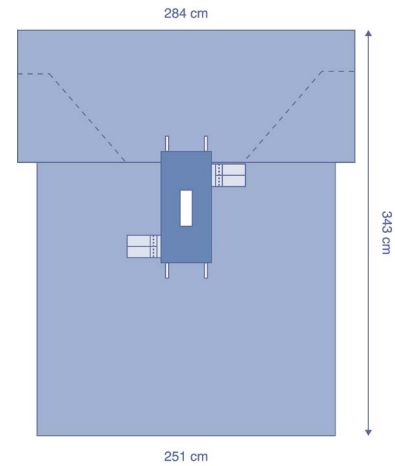

## TB9448CE – Craniotomy drape

12 ea/cs

Item order	Component	Size	Comp qty.	Material
TB9448	Craniotomy drape, fenestration 28x18 cm with incise film	254x241 cm	1	Trilaminare
1025B	Wrap		1	SMS

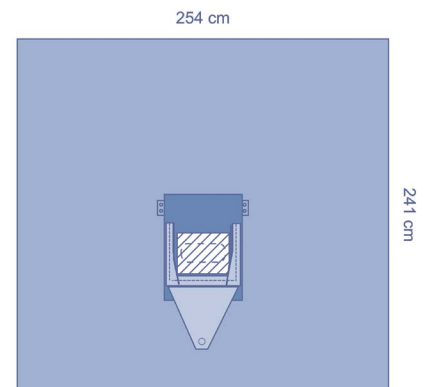

## CPU29033CE – Spine pack

10 ea/cs

Item order	Component	Size	Comp qty.	Material
8339	Mayo stand cover	80x142 cm	1	PE
TB80373	Spine drape, fenestration 10x20 cm with full incise film	220x320 cm	1	Trilaminare
BTCM25	Back table cover, 75µm	140x190 cm	1	PP/PE

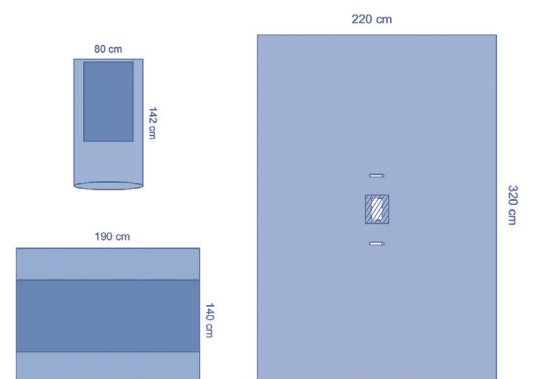



## CPU29242CE – Spine pack

8 ea/cs

Item order	Component	Size	Comp qty.	Material
04A035	OP-tape	8x40 cm	2	PE
TB307555	Adhesive drape	49x65 cm	4	Trilaminare
TB29510	Laparotomy drape, fenestration 23x37 cm with full incise film	196/254x314 cm	1	Trilaminare
BTCM15	Back table cover, 50µm	140x190 cm	1	PP/PE
1025B	Wrap		1	SMS

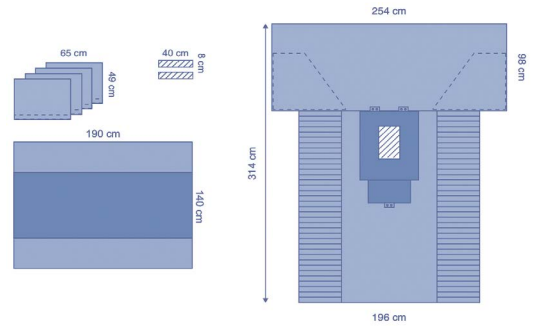

## CP29008CE – Craniotomy pack

4 ea/cs

Item order	Component	Size	Comp qty.	Material
BTCS16	Back table cover, 50µm	140x120 cm	1	PP/PE
04A035	OP-tape	8x40 cm	4	PE
TB3215	Adhesive drape	45x49 cm	6	Trilaminare
9448	Neurosurgery drape, fenestration 28x18 cm with incise film	241x254 cm	1	Spunlace
F2932	Adhesive drape, reinforced	240x196 cm	1	Spunlace
BTCM15	Back table cover, 50µm	140x190 cm	1	PP/PE
1025B	Wrap		1	SMS

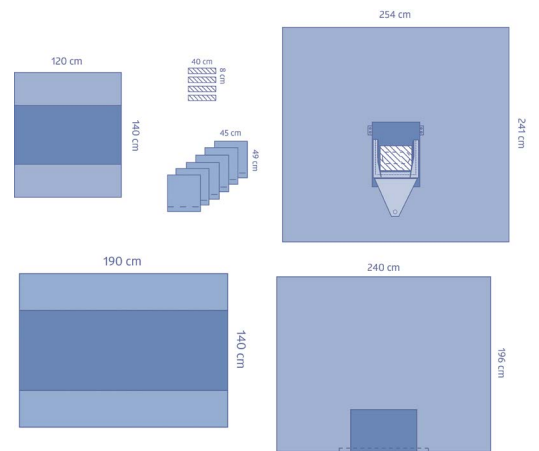

## CP29544CE – Craniotomy pack

4 ea/cs

Item order	Component	Size	Comp qty.	Material
8530	Absorbent hand towel	30x39 cm	2	Cellulose
04A035	OP-tape	8x40 cm	1	PE
TB307554	Adhesive drape	49x65 cm	4	Trilaminare
9444	Drape sheet	249x196 cm	1	Spunlace
BTCM26	Back table cover, 75µm, folded	140x190 cm	1	PP/PE
9448	Craniotomy drape, fenestration 28x18 cm with incise film	241x254 cm	1	Spunlace
BTCM25	Back table cover, 75µm	140x190 cm	1	PP/PE
1025B	Wrap		1	SMS

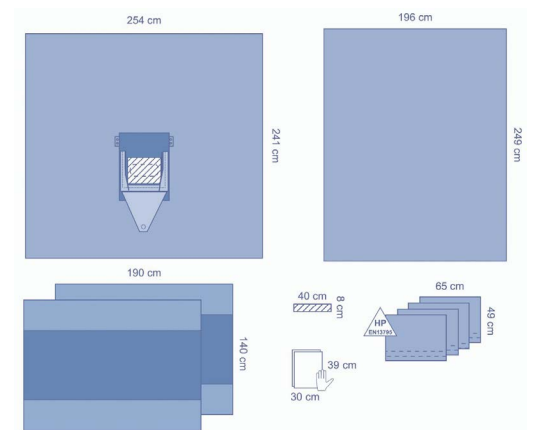

**SM29545GCE – Craniotomy pack**

6 ea/cs

Item order	Component	Size	Comp qty.	Material
S3516	Essential OR gown	XL, 150 cm	1	SMS
8339	Mayo stand cover	80x142 cm	1	PE
ES02C215	Adhesive drape	45x50 cm	4	Bilaminate
ES02C225	Drape sheet	45x50 cm	1	Bilaminate
ES11600	Foot drape	175x175 cm	1	Bilaminate
ZHE750	OP-tape	9x50 cm	2	Spunlace
10001SM	Craniotomy drape, fenestration 28x20 cmcm with full incise film	264x252 cm	1	SMS
BTCM15	Back table cover, 50µm	140x190 cm	1	PP/PE

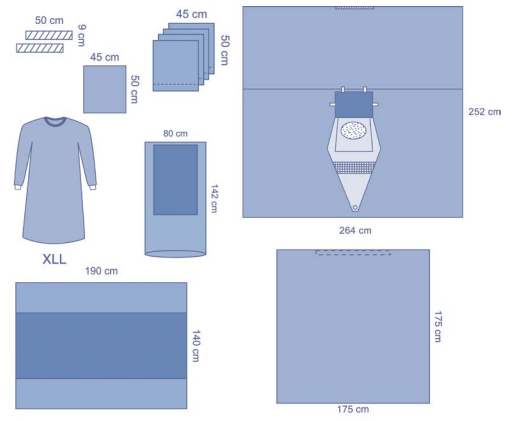
**CP9448CEA – Craniotomy pack**

4 ea/cs

Item order	Component	Size	Comp qty.	Material
8339	Mayo stand cover	80x142 cm	1	PE
8520	Absorbent hand towel	39x58 cm	4	Cellulose
7014WP	Hook and loop tube holder	2.5x14 cm	1	Polyester
ZHE750	OP-tape	9x50 cm	3	Spunlace
04A036	Instrument pouch, 2 compartments	33x41 cm	1	Clear PE film
TB3215	Adhesive drape	45x49 cm	4	Trilaminare
TB29478	Head drape, reinforced	254x183 cm	1	Trilaminare
100405	Craniotomy drape, fenestration 30x20 cm with full incise film	188/297x343 cm	1	Spunlace
BTCXL35	Back table cover, 90µm	203x240 cm	1	PP/PE
1025B	Wrap		1	SMS

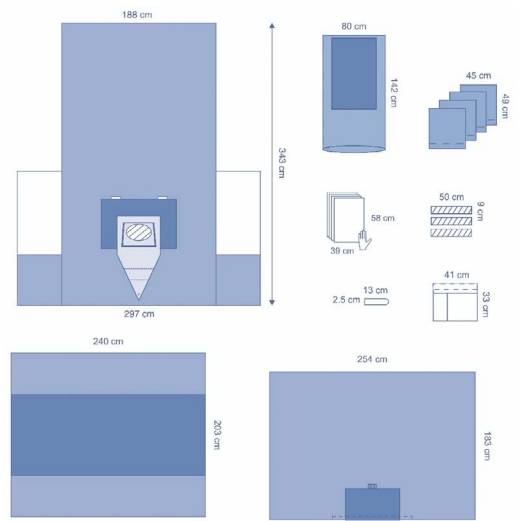
**ES10548CE – Craniotomy pack**

6 ea/cs

Item order	Component	Size	Comp qty.	Material
MAY0M	Mayo stand cover	80x145 cm	2	PE
ES02C215	Adhesive drape	45x50 cm	4	Bilaminate
04A035	OP-tape	8x40 cm	2	PE
ES10548	Craniotomy drape, fenestration 20x33 cm with full incise film	236x406 cm	1	Bilaminate
BTCM15	Back table cover, 50µm	140x190 cm	1	PP/PE

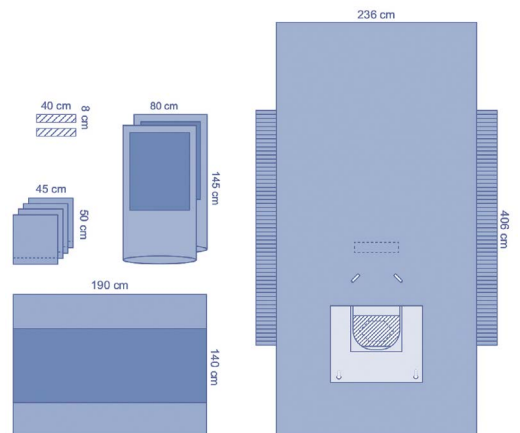

**CPE10024CE – Craniotomy pack**

2 ea/cs

Item order	Component	Size	Comp qty.	Material
S3513P	Essential OR gown, polyreinforced, MD/PPE	XL, 150 cm	1	SMS
8520	Absorbent hand towel	39x58 cm	12	Cellulose
S3513P	Essential OR gown, polyreinforced, MD/PPE	XL, 150 cm	2	SMS
8340	Mayo stand cover, ultra-reinforced	80x145 cm	1	PE
ZHE750	OP-tape	9x50 cm	2	Spunlace
ES30056	Adhesive drape	196x150 cm	1	Bilaminate
ES10481	Head drape	260x160 cm	1	Bilaminate
ES10548	Craniotomy drape, fenestration 20x33 cm with full incise film	236x406cm	1	Bilaminate
BTCXL35	Back table cover, 90µm	203x240 cm	1	PP/PE
1025B	Wrap		1	SMS

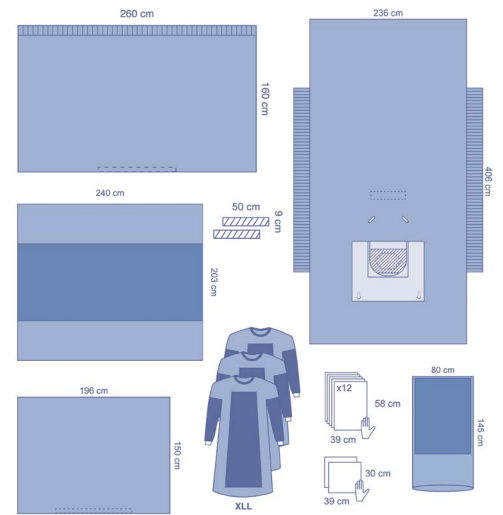

# Angiography drapes and packs

## TB27007CE – Collar drape

60 ea/cs

Item order	Component	Size	Comp qty.	Material
TB27007	Collar drape, fenestration 16 cm	86x65 cm	1	Trilaminate
1025B	Wrap		1	SMS

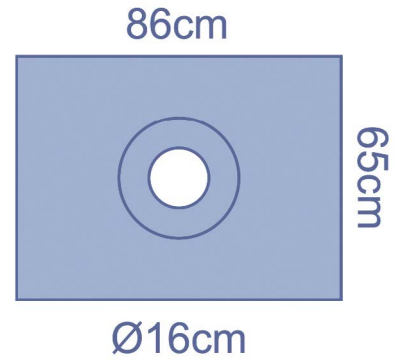

## TB29458CE – Radial drape

50 ea/cs

Item order	Component	Size	Comp qty.	Material
TB29458	Angiography drape, 10 cm fenestration	97x112 cm	1	Trilaminate
1025B	Wrap		1	SMS

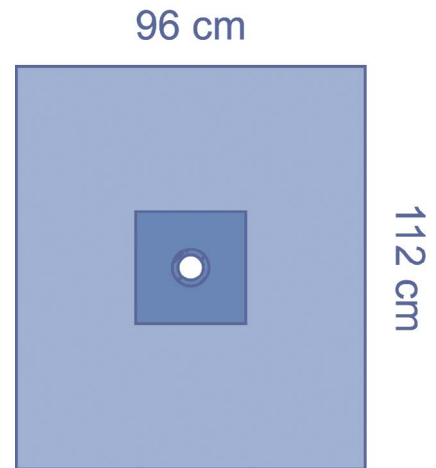

## ESAG3521CE – Femoral drape

12 ea/cs

Item order	Component	Size	Comp qty.	Material
ESAG3521	Angiography drape, 2 fenestrations	239x370 cm	1	Bilaminate
1025B	Wrap		1	SMS

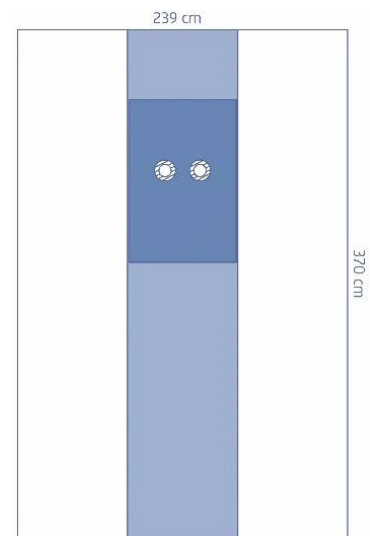

### TBAG202CE – Femoral drape

12 ea/cs

Item order	Component	Size	Comp qty.	Material
TBAG202	Angiography drape, 2 fenestrations	221x290 cm	1	Trilaminare
1025B	Wrap		1	SMS

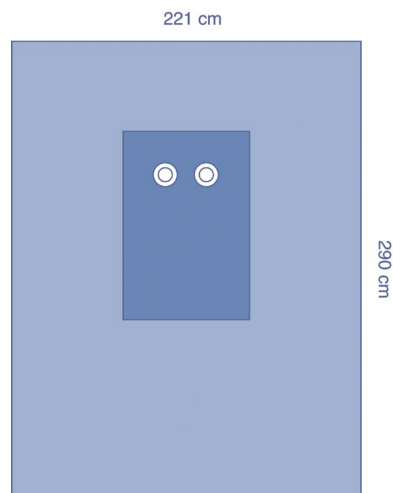

### TBAG252CE – Femoral drape

12 ea/cs

Item order	Component	Size	Comp qty.	Material
TBAG252	Angiography drape, 2 fenestrations	221x290 cm	1	Trilaminare
1025B	Wrap		1	SMS

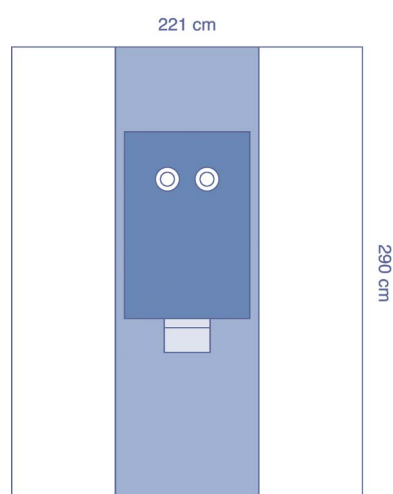

### TBAG292CE – Femoral drape

12 ea/cs

Item order	Component	Size	Comp qty.	Material
TBAG292	Angiography drape, 2 fenestrations	226x290 cm	1	Trilaminare
1025B	Wrap		1	SMS

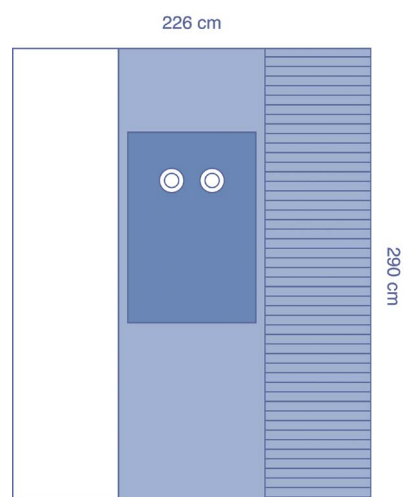

**TBAG3521CE – Femoral drape**

12 ea/cs

Item order	Component	Size	Comp qty.	Material
TBAG3521	Angiography drape, 2 fenestrations	196x343 cm	1	Trilaminare
1025B	Wrap		1	SMS

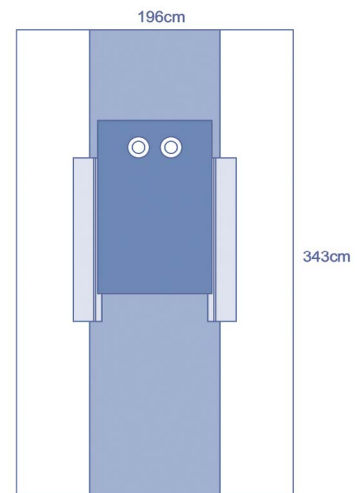

**TBAG352CE – Femoral drape**

12 ea/cs

Item order	Component	Size	Comp qty.	Material
TBAG352	Angiography drape, 2 fenestrations	221x343 cm	1	Trilaminare
1025B	Wrap		1	SMS

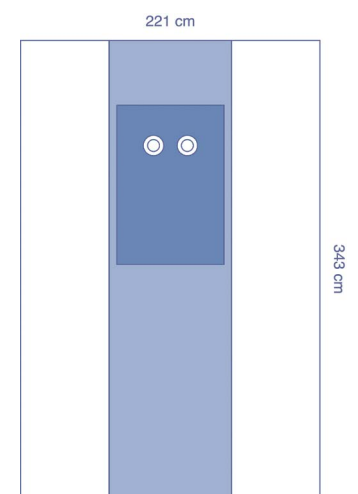

**TBAG392CE – Femoral drape**

8 ea/cs

Item order	Component	Size	Comp qty.	Material
TBAG392	Angiography drape, 2 fenestrations	241x343 cm	1	Trilaminare
1025B	Wrap		1	SMS

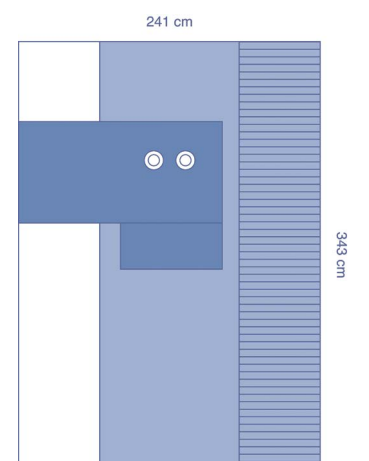

## TBAG3525CE – Femoral drape

12 ea/cs

Item order	Component	Size	Comp qty.	Material
TBAG3525	Angiography drape, 2 fenestrations	221x371 cm	1	Trilaminare
1025B	Wrap		1	SMS

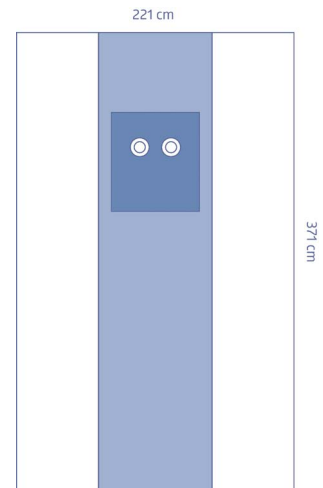

## ESAG3541CE – Angiography drape

10 ea/cs

Item order	Component	Size	Comp qty.	Material
ESAG3541	Angiography drape, 4 fenestrations	244x370 cm	1	Bilaminare
1025B	Wrap		1	SMS

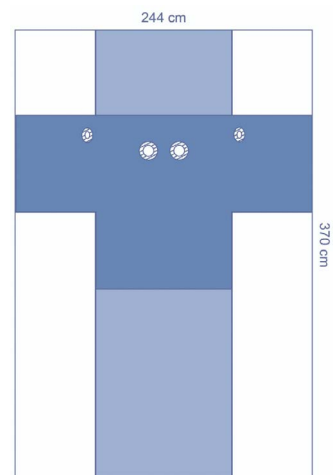

## ES29540CE – Angiography pack

6 ea/cs

Item order	Component	Size	Comp qty.	Material
BB30W	Banded bag, circular	135 cm	1	PE
7471	Absorbent hand towel	30x20 cm	2	Cellulose
ES02C215	Adhesive drape	45x50 cm	1	Bilaminare
ESAG3521	Angiography drape, 2 fenestrations	239x370 cm	1	Bilaminare
BTCM15	Back table cover, 50µm	140x190 cm	1	PP/PE
1025B	Wrap		1	SMS

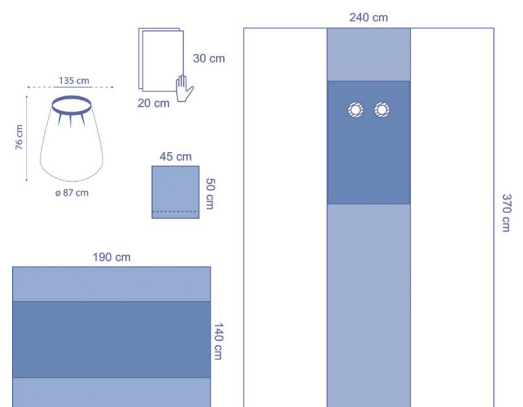

### CP29046CE — Angiography pack

6 ea/cs

Item order	Component	Size	Comp qty.	Material
8520	Absorbent hand towel	39x58 cm	4	Cellulose
BB20P	Banded bag, circular	100 cm	1	PE
TBAG252	Angiography drape, 2 fenestrations	221x290 cm	1	Trilaminate
BTCM15	Back table cover, 50µm	140x190 cm	1	PP/PE

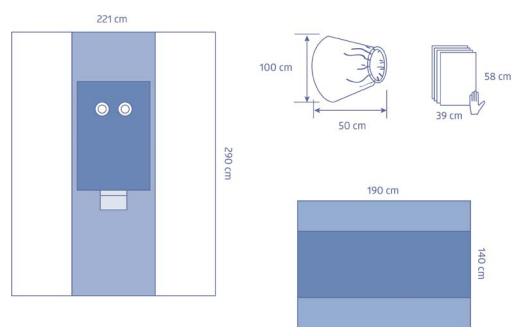

### CPU29053CE — Angiography pack

8 ea/cs

Item order	Component	Size	Comp qty.	Material
TB9358	Drape sheet	112x145 cm	2	Trilaminate
BB3538B	Banded bag, rectangular	85x95 cm	1	Clear PE
ZHE750	OP-tape	9x50 cm	1	Spunlace
TBAG352	Angiography drape, 2 fenestrations	221x343 cm	1	Trilaminate
BTCS15	Back table cover, 50µm	120x140 cm	1	PP/PE

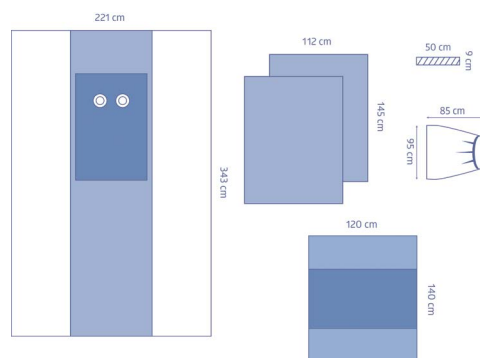

### TB29560CE — Angiography pack

6 ea/cs

Item order	Component	Size	Comp qty.	Material
8520	Absorbent hand towel	39x58 cm	2	Cellulose
ES02C211	Adhesive drape	90x75 cm	1	Bilaminate
TB29559	Angiography drape, 4 fenestrations	226/243x352 cm	1	Trilaminate
BTCM15	Back table cover, 50µm	140x190 cm	1	PP/PE
1025B	Wrap		1	SMS

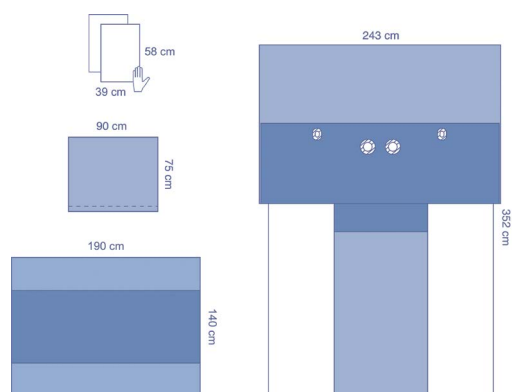



# Cardiology drapes and packs

## TB29154 – Cardiology split drape

8 ea/cs

Item order	Component	Size	Comp qty.	Material
TB29154	Cardiovascular split drape, U adhesive 13x200 cm	236/254x312cm	1	Trilaminate
C1034	Wrap		1	Cellulose

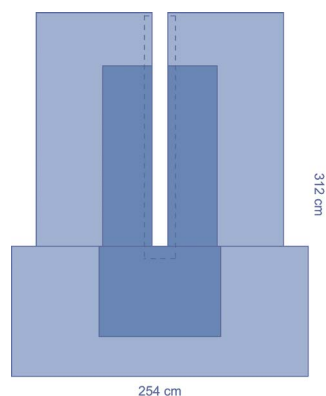

## TB29420CE – Thoracic drape

15 ea/cs

Item order	Component	Size	Comp qty.	Material
TB29420	Thoracic drape, adhesive fenestration 36x28cm	254/196x310 cm	1	Trilaminate
1025B	Wrap		1	SMS

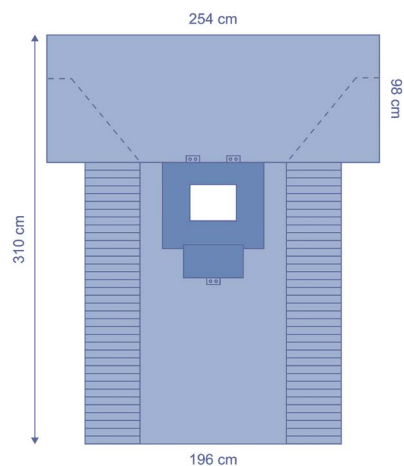

## TB9159CE – TAVI drape

5 ea/cs

Item order	Component	Size	Comp qty.	Material
TB9159	TAVI drape, 3 fenestration with incise film	240/290x448 cm	1	Trilaminate
1025B	Wrap		1	SMS

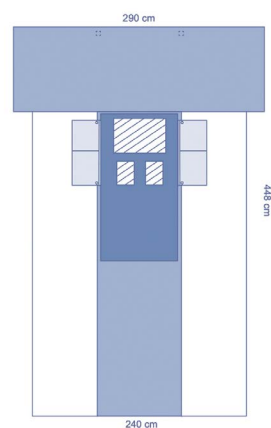

**TB29159CE – TAVI pack**

5 ea/cs

Item order	Component	Size	Comp qty.	Material
TB9159	TAVI drape, 3 fenestration with incise film	240/290x448 cm	1	Trilaminare film
ES02C212	Adhesive drape	75x75 cm	4	Bilaminare
1025B	Wrap		1	SMS
BTCM15	Back table cover, 50µm	140x190 cm	1	PP/PE

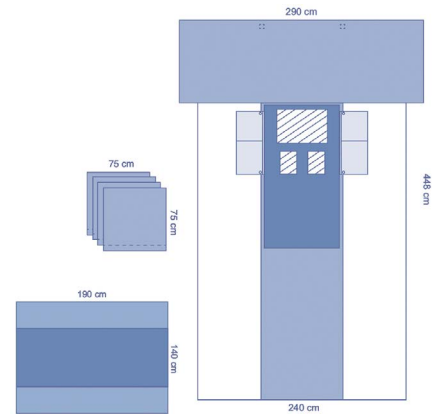

**ES29561CE – Cardiology pack**

4 ea/cs

Item order	Component	Size	Comp qty.	Material
8340	Mayo stand cover, ultra-reinforced	80x145 cm	1	PE
7471	Absorbent hand towel	30x20 cm	6	Cellulose
BTCM16	Back table cover, 50µm	140x190 cm	1	PP/PE
04A039	Instrument pouch, 1 compartment	33x41 cm	1	PE
7023W	Hook and loop tube holder	2,5x23 cm	2	PET
ZHE750	OP-tape	9x50 cm	3	Spunlace
ES9680	Booties	29x33 cm	2	Bilaminare
9680	Booties	29x33 cm	2	PE
ES02C212	Side drape	75x75 cm	2	Bilaminare
ES9149	Peri-goïn drape	200x260 cm	1	Bilaminare
31405	Back table cover, 50µm	152x230 cm	1	PP/PE
ES29561	Cardiac drape, fenestration 32x40 cm with full incise film	200/290x338 cm	1	Bilaminare
1025B	Wrap		1	SMS

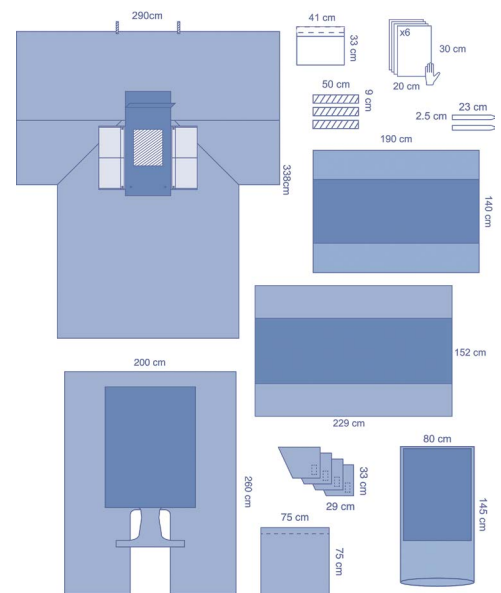

**CP29225CE – Cardiovascular pack**

3 ea/cs

Item order	Component	Size	Comp qty.	Material
9686	Instrument pouch	29x27 cm	1	Spunlace
TB3007	Perineal drape	16x37 cm	1	Trilaminare
8530	Absorbent hand towel	30x39 cm	1	Cellulose
953	Adhesive drape	98x98 cm	1	Spunlace
BTCXL36	Back table cover, 90µm, folded	203x240 cm	1	PP/PE
04A035	OP-tape	8x40 cm	4	PE
TB307554	Adhesive drape	49x65 cm	2	Trilaminare
F2002	Absorbent panel	49x50 cm	2	Polyrayon
29154	Cardiovascular split drape, U adhesive 13x200 cm	236/254x312cm	1	Spunlace
9461	Drape sheet	98x98 cm	1	Spunlace
29466	Side drape, reinforced	183 x 190 cm	1	Spunlace
BTCL35	Back table cover, 90µm	160x240 cm	1	PP/PE
1025B	Wrap		1	SMS

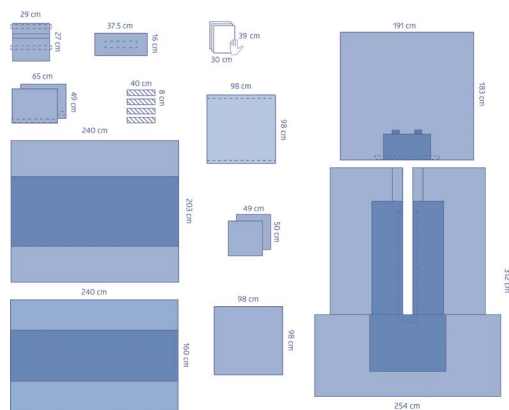

# Pacemaker drapes and packs

## ES10020CE — Pacemaker drape

24 ea/cs

Item order	Component	Size	Comp qty.	Material
ES10020	Fenestrated drape, adhesive fenestration 15x15 cm	200x280 cm	1	Bilaminate
1025B	Wrap		1	SMS

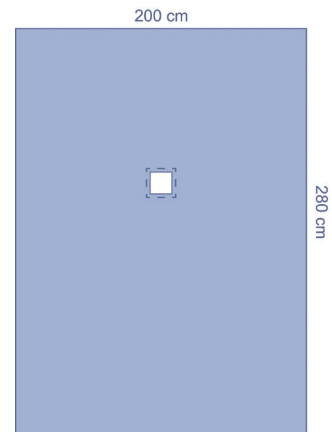

## ES9409CE — Pacemaker drape

14 ea/cs

Item order	Component	Size	Comp qty.	Material
ES9409	Fenestrated drape, reinforced adhesive fenestration 12x14 cm	262x360cm	1	Bilaminate
1025B	Wrap		1	SMS

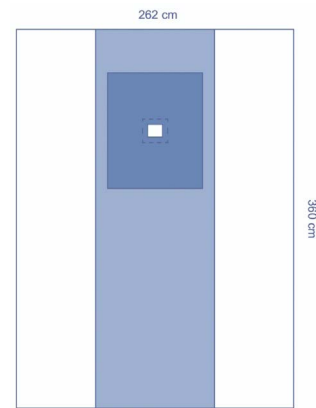

## ES10021CE — Pacemaker pack

16 ea/cs

Item order	Component	Size	Comp qty.	Material
ZHE750	OP-tape	9x50 cm	1	Spunlace
ES10021	Fenestrated drape, adhesive fenestration 15x15 cm	220x240 cm	1	Bilaminate
BTCM15	Back table cover, 50µm	140x190 cm	1	PP/PE
1025B	Wrap		1	SMS

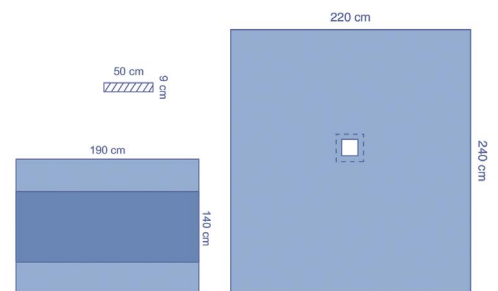

## TB9408CE – Pacemaker pack

8 ea/cs

Item order	Component	Size	Comp qty.	Material
TB9407	Fenestrated drape, reinforced adhesive fenestration 15x15 cm	210x316 cm	1	Trilaminare
BTCM15	Back table cover, 50µm	140x190 cm	1	PP/PE
1025B	Wrap		1	SMS

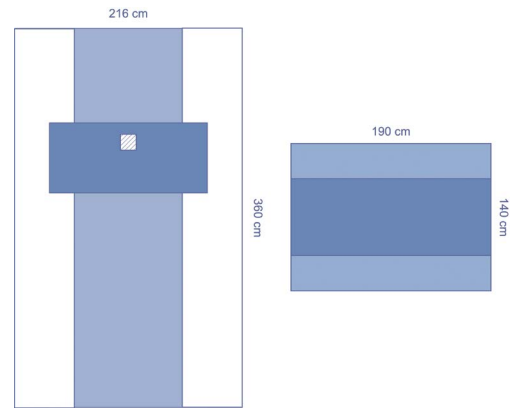

# Vascular drapes and packs

## TB29500CE – Vascular drape

24 ea/cs

Item order	Component	Size	Comp qty.	Material
ES10020	Fenestrated drape, adhesive fenestration 15x15 cm	200x280 cm	1	Bilaminare
1025B	Wrap		1	SMS

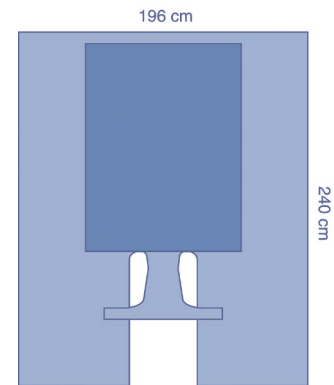

## ES10120CE – Varicose pack

8 ea/cs

Item order	Component	Size	Comp qty.	Material
7471	Absorbent hand towel	30x20 cm	2	Cellulose
ES1007	Drape sheet	200x150 cm	1	Bilaminare
ES1009	Split drape, U adhesive 6,5x95 cm	150x230 cm	1	Bilaminare
ES10481	Head drape	260x160 cm	1	Bilaminare
BTCM15	Back table cover, 50µm	140x190 cm	1	PP/PE
1025B	Wrap		1	SMS
ES02C212	Side drape	75x75 cm	1	Bilaminare

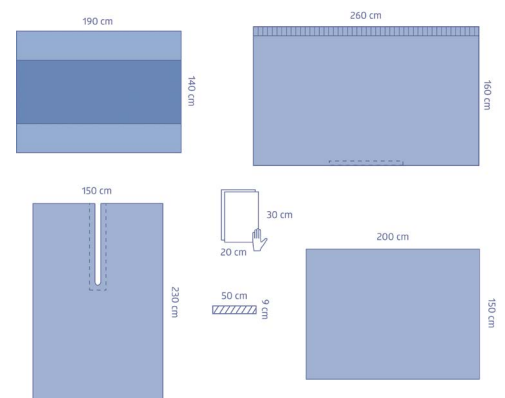

### TB30120CE – Varicose pack

8 ea/cs

Item order	Component	Size	Comp qty.	Material
7471	Absorbent hand towel	30x20 cm	1	Cellulose
7014WP	Hook and loop tube holder	2.5x14 cm	1	Polyester
TB3008	Head drape, adhesive	240X180 cm	1	Trilaminare
TB3007	Perineal drape	16x37 cm	1	Trilaminare
TB3009	Split drape, U adhesive 28x60 cm	180x240 cm	1	Trilaminare
BTCM15	Back table cover, 50µm	140x190 cm	1	PP/PE
1025B	Wrap		1	SMS

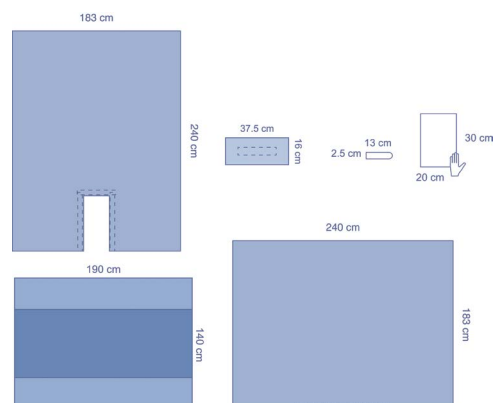

### ES29120CE – Varicose pack

8 ea/cs

Item order	Component	Size	Comp qty.	Material
7471	Absorbent hand towel	30x20 cm	1	Cellulose
7014WP	Hook and loop tube holder	2.5x14 cm	1	Polyester
ES3008	Head drape, adhesive	240X180 cm	1	Bilaminare
ES3007	Perineal drape	16x37 cm	1	Bilaminare
ES29009	Split drape, U adhesive 28x60 cm	183x240 cm	1	Bilaminare
BTCM15	Back table cover, 50µm	140x190 cm	1	PP/PE
1025B	Wrap		1	SMS

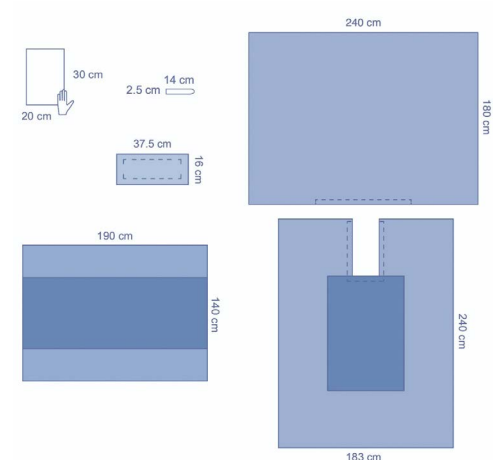

### CPE10014CE – Varicose pack

2 ea/cs

Item order	Component	Size	Comp qty.	Material
S3540P	Essential OR gown, polyreinforced, MD/PPE	XL, 140 cm	1	SMS
8530	Absorbent hand towel	30x39 cm	4	Cellulose
S3513P	Essential OR gown, polyreinforced, MD/PPE	XL, 150 cm	2	SMS
8339	Mayo stand cover	80x142 cm	1	PE
04A036	Instrument pouch, 2 compartments	33x41 cm	1	Clear PE
36975E	Stockinette	20x97 cm	1	PP/PE
7023W	Hook and loop tube holder	2,5x23 cm	2	PET
ZHE750	OP-tape	9x50 cm	2	Spunlace
ES11600	Foot drape	175x175 cm	1	Bilaminare
ES9424	Split drape, U adhesive 8,5x107 cm	220x300 cm	1	Bilaminare
ES10481	Head drape	260x160 cm	1	Bilaminare
BTCL25	Back table cover, 75µm	240x160 cm	1	PP/PE
1025B	Wrap		1	SMS

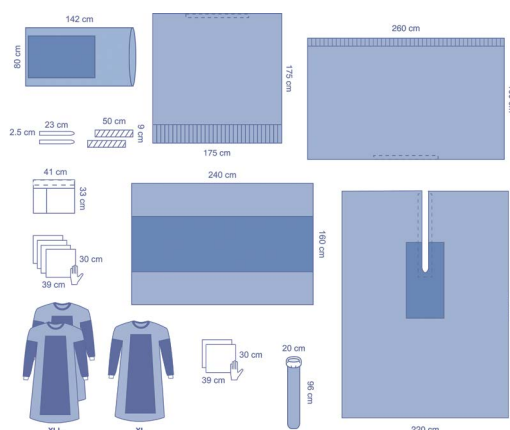

# Table covers

## Standard table covers\*

Item order	Component	PE thickness	Reinforcement	Size	Qty/cs	Material
DYJPETC001	TC001	50 µm	Polypropylene, 64x112 cm	110x112 cm	20	PP/PE
8368CEA	BTCS16	50 µm	Polypropylene, 64x120 cm	120x140 cm	30	PP/PE
DYNJPE2309	61026	50 µm	Polypropylene, 64x190 cm	110x190 cm	22	PP/PE
8371CEB	BTCL16	50 µm	Polypropylene, 74x190 cm	140x190 cm	22	PP/PE
DYJPETC065	TC065	50 µm	Polypropylene, 74x152 cm	152x152 cm	22	PP/PE
DYJPETC060	TC060	50 µm	Polypropylene, 74x190 cm	152x190 cm	22	PP/PE
8378CEB	BTCL16	50 µm	Polypropylene, 74x230 cm	125x230 cm	18	PP/PE
DYNJPE2320	2320	50 µm	Polypropylene, 74x230 cm	152x229 cm	22	PP/PE
DYNJPE2312	2312	60 µm	Wetlaid, 102x229 cm	196x229 cm	22	Cellulose/PE

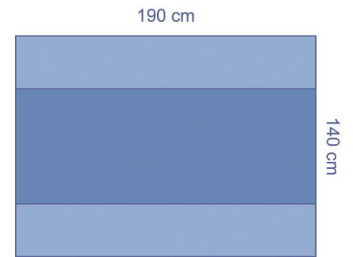

Accessories

## Thick table covers\*

Item order	Component	PE thickness	Reinforcement	Size	Qty/cs	Material
2100CEB	BTCS26	75 µm	Polypropylene, 66x120 cm	140x120 cm	26	PP/PE
1900CEB	BTCL26	75 µm	Polypropylene, 74x190 cm	140x190 cm	22	PP/PE
8380CEB	BTCXL26	75 µm	Polypropylene, 100x240 cm	203x240 cm	14	PP/PE

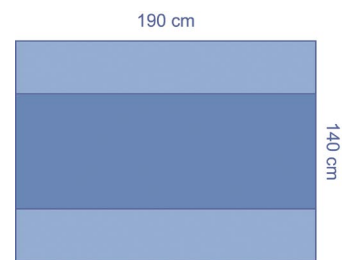

## Heavy duty table covers\*

Item order	Component	PE thickness	Reinforcement	Size	Qty/cs	Material
DYNJPE2314	E37466	90 µm	Wetlaid, 76x229 cm	152x229 cm	12	Cellulose/PE
8186CEB	BTCL36	90 µm	Polypropylene, 74x240 cm	160x240 cm	14	PP/PE
DYNJPE2317	2317	90 µm	Polypropylene, 102x279 cm	201x279 cm	12	PP/PE

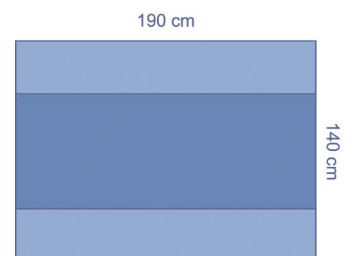

\*Delivered in wrap

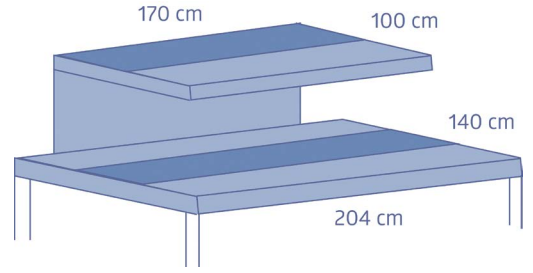

**Double table cover\***

Item order	Component	PE thickness	Reinforcement	Size	Qty/cs	Material
8363CE	8363	55 µm	Polyrayon, 60x204 cm/60x165 cm	140x204 cm/100x170 cm	12	Viscose/PET/PE

**Standard mayo stand covers\***

Item order	Component	Reinforcement	Size	Qty/cs	Material
8337CEA	8337	Polypropylene, 46x61 cm	59x141 cm	56	PP/PE
8339CEC	8339	Polypropylene, 55x88 cm	80x142 cm	50	PP/PE

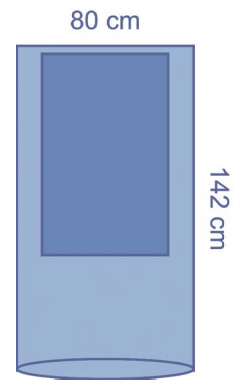

**Heavy duty mayo stand covers\***

Item order	Component	Reinforcement	Size	Qty/cs	Material
8338CE	8338	Viscose/PET, 55x88 cm	80x142 cm	44	Viscose/PET/PE
DYJPEMAYOM	MAYOM	Polyrayon, 61x85 cm	80x145 cm	30	PP/PE
8340CEA	8340	Viscose/PET, 75x100 cm	80x145 cm	28	Viscose/PET/PE

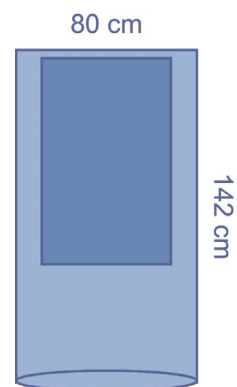

\*Delivered in wrap



# Leggings & stockinettes

## Leggings\*

Item order	Component	Component description	Comp qty.	Size	Qty/cs	Material
ES8420CE	ES8420	Legging, impervious	2	79x120 cm	36	Bilaminate
DYNJPE2460SM	2460SM	Legging, breathable	2	79x122 cm	20	SMS
8420CEB	8420	Legging, breathable	2	79x140 cm	26	SMS
8430CEA	8430	Legging with clear panel	2	80x143 cm	24	SMS/PE

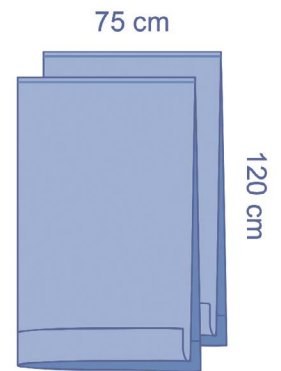

## Foot cover\*

Item order	Component	Component description	Comp qty.	Size	Qty/cs	Material
DYJPEBOPSM	BOPSM	Bootee with 5x10 cm adhesive tape	2	32/43x29 cm	30	SMS

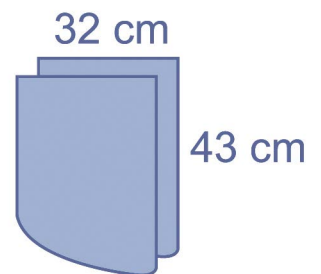

\*Delivered in wrap

# Under-buttocks

## Under-buttocks\*

Item order	Component	Component description	Size	Qty/cs	Material
DYNJPE6001	2490	Under-buttocks drape, with wetlaid reinforcement 18x89 cm on cuff	89x119 cm	40	PE/Wetlaid

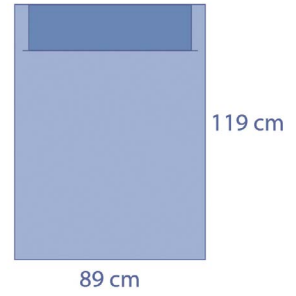

## Under-buttocks\*

Item order	Component	Component description	Size	Qty/cs	Material
8483CEA	8483	Under-buttocks drape, with 37x52 cm and 24x52 cm reinforcements	96x126 cm	56	PE/SMS

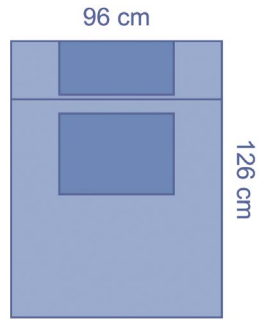

## Under-buttocks with pouch\*

Item order	Component	Component description	Size	Qty/cs	Material
DYNJPE6002	E08454	Under-buttock drape, fluid collection pouch 74x81 cm with filter and exit port	85x36 cm	20	PE/Wetlaid
8482CEA	8482	Under-buttock drape, fluid collection pouch 86x58 cm cm with filter and exit port	96x92 cm	36	PE/SMS

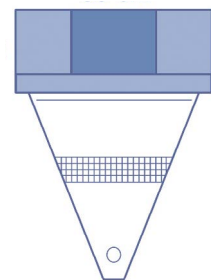

\*Delivered in wrap

### Under-buttocks with pouch\*

Item order	Component	Component description	Size	Qty/cs	Material
DYJPEFP016	FP016	Under-buttock drape, reinforcement 41x41 cm, pouch 69x75 cm with filter and exit port	89x117cm	30	PE/ Polyrayon
DYNJPE6004	6004	Under-buttock drape, with pouch		20	PE/SMS

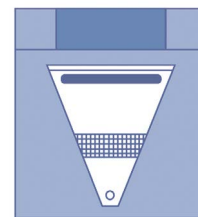

### Under-buttocks with graduated pouch\*

Item order	Component	Component description	Size	Qty/cs	Material
8484CEA	8484	Under-buttock drape with cuff, fluid collection pouch with graduations	96,5x118 cm	36	PE/ Polyrayon

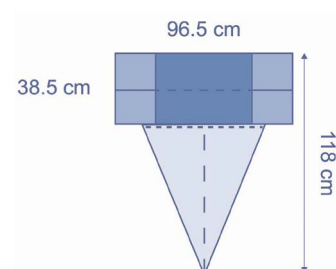

### Under-buttocks with graduated pouch\*

Item order	Component	Component description	Size	Qty/cs	Material
4576CE	4576	Under-buttock drape, with 2 pouches and graduations	96x120 cm	40	SMS/PE

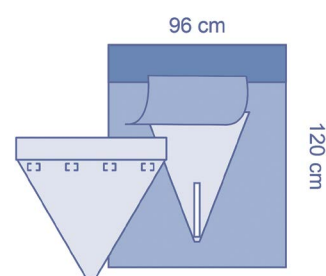

\*Delivered in wrap

**Fluid collection pouches with filter**

Item order	Component	Component description	Size	Qty/cs	Material
4638CE	4638	Fluid collection pouch with filter and exit port	51x61 cm	40	Clear PE

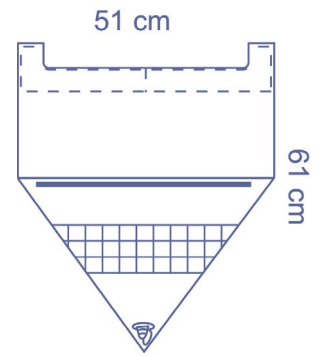

**Fluid collection pouches with filter**

Item order	Component	Component description	Size	Qty/cs	Material
IDE1016		Fluid collection pouch, adhesive, with filter and exit port	51x36 cm	40	Frosted PE

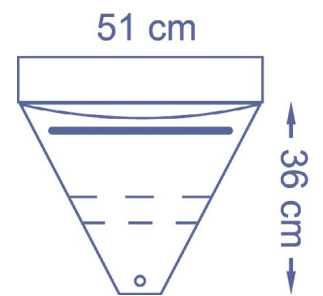

**Fluid collection pouches with filter**

Item order	Component	Component description	Size	Qty/cs	Material
DYJPEFP020	FP020	Fluid collection pouch, adhesive, with filter and exit port	51x56 cm	50	PE

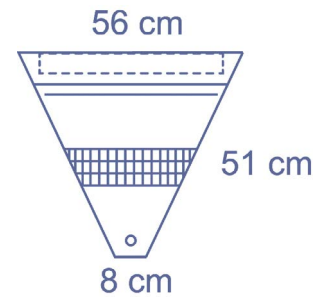

### Fluid collection pouch for ophthalmics

Item order	Component	Component description	Size	Qty/cs	Material
IDE2114		Fluid collection pouch, adhesive	30x28 cm	40	Clear PE

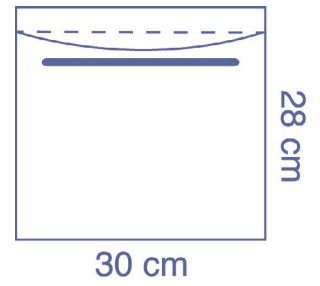

### Fluid collection pouch for ophthalmics

Item order	Component	Component description	Size	Qty/cs	Material
IDE1023	IDE1023	Ophthalmic pouch, fenestration 13x10cm with full incise film	48x41cm	40	Clear PE

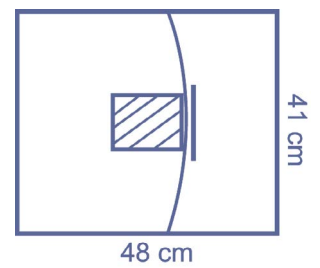

### Fluid collection pouch for ophthalmics

Item order	Component	Component description	Size	Qty/cs	Material
IDE1024	IDE1024	Ophthalmic pouch, fenestration 13x10cm with incise film apertured 3,5x6 cm	48x41cm	40	Frosted PE

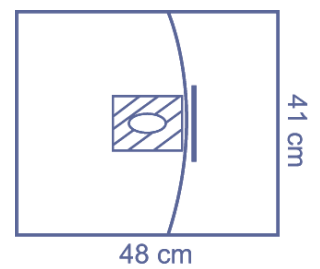

### Fluid collection pouch for caesarian

Item order	Component	Component description	Size	Qty/cs	Material
IDE2057	IDE2057	360 degree cesarean pouch, fenestration 35x33 cm with incise film, 2 exit ports	92x76 cm	10	Frosted PE

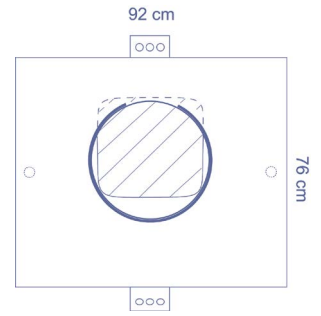

### Shoulder fluid collection pouch

Item order	Component	Component description	Size	Qty/cs	Material
DYJPEFP090	FP090	Fluid collection pouch, adhesive, with 2 exit port	112x76cm	25	Clear PE

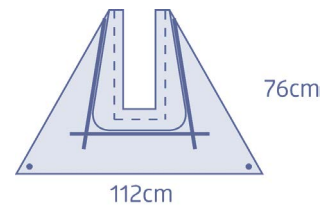

### Shoulder fluid collection pouch

Item order	Component	Component description	Size	Qty/cs	Material
IDE1067	IDE1067	Shoulder pouch, adhesive fenestration 19x25.5cm, 2 exit ports	91/63.5x74 cm	24	Frosted PE

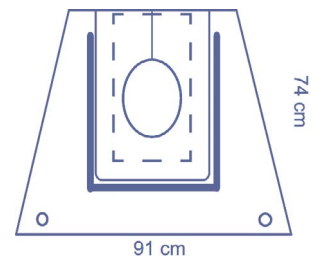

# Instrument pouches and swab collectors

## Clear instrument pouches

Item order	Component	Number of compartments	Size	Qty/cs	Material
IDE1018	IDE1018	2	17x29 cm	40	Frosted PE
IDE1018L	IDE1018L	3	25x47 cm	40	Frosted PE

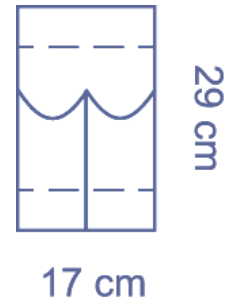

## Clear instrument pouches

Item order	Component	Number of compartments	Size	Qty/cs	Material
DYJPEISTPOM2	ISTPOM2	1	41x33 cm	100	Clear PE
04A040CE	04A040	1	51x33 cm	180	Clear PE
DYJPEISTPOM1	ISTPOM1	2	41x33 cm	100	Clear PE

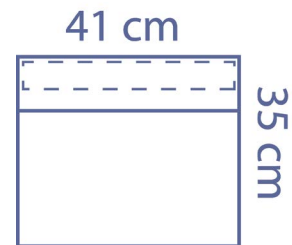

## Clear instrument pouches

Item order	Component	Number of compartments	Size	Qty/cs	Material
96860CE	9686	1	30.5 x 29 cm	150	Clear PE
96890CE	9689	2	49x43 cm	250	Clear PE
DYJPEISTPOM3	ISTPOM3	3	48x43 cm	60	Clear PE

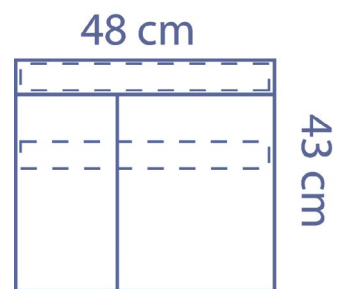

### Non-woven instrument pouches

Item order	Component	Number of compartments	Size	Qty/cs	Material
9686CE	9686	1	29x27 cm	150	Spunlace
9689CE	9689	2	49x43.5 cm	150	Spunlace

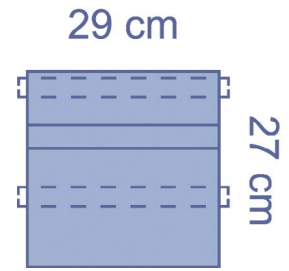

### Saddle instrument pouch

Item order	Component	Number of compartments	Size	Qty/cs	Material
9687CE	9687	2	29x27 cm	150	Spunlace

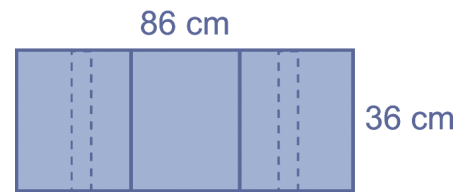

### Tube pocket

Item order	Component	Component description	Size	Qty/cs	Material
8341CE	8341	Tube pocket, adhesive	90x92 cm	32	PP/PE

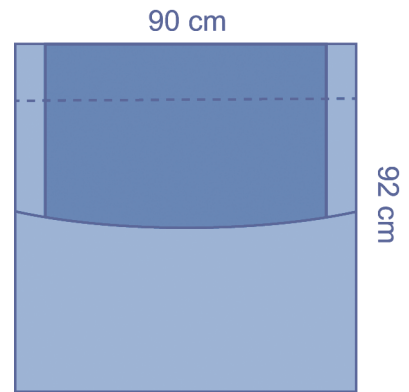



# Miscellaneous

## Clear instrument pouches

Item order	Component	Component description	Comp qty.	Size	Qty/cs	Material
7023WCE	7023W	Hook and loops tube holder	1	23x2,5 cm	400	PET
DYNJPE2216	7014WP	Hook and loops tube holder, one side sealed	2	14x2,5 cm	50	PET

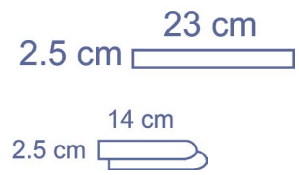

## OP-tapes

Item order	Component	Component description	Comp qty.	Size	Qty/cs	Material
3527CE		OP-tape, impervious	1	50x9 cm	480	Bilaminate
3525CEA		OP-tape, non-woven	1	50x9 cm	480	Spunlace
3535CE		OP-tape, clear and impervious	1	55x9 cm	600	Clear PE
DYJPETAPSM		OP-tape, non-woven	1	50x10 cm	120	SMS
3528CE		OP-tape, impervious	2	50x9 cm	390	Bilaminate
3550CEA		OP-tape, non-woven	2	50x9 cm	390	Spunlace
3532CEA		OP-tape, clear and impervious	2	40x8 cm	390	Clear PE
DYJPETAPSM2		OP-tape, non-woven	2	50x10 cm	100	SMS

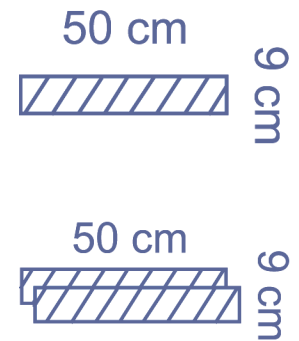

## Hand towels

Item order	Component	Component description	Comp qty.	Size	Qty/cs	Material
DYNJPE2220A	HNTOM3	Hand towel with scrim	2	37x69 cm	100	Cellulose
7550CEA	8520	Hand towel with scrim	2	37x69 cm	150	Cellulose

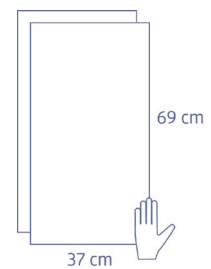

### Sleeves

Item order	Component	Component description	Comp qty.	Size	Qty/cs	Material
599CEB	599	Breathable sleeve, with elastic	1	55x14 cm	150	SMS
ES597CE	ES598	Impervious sleeve, with cuff	1	62x14 cm	225	Bilaminate
598CE	598	Breathable and impervious sleeves, with cuff, MD/PPE certified, Chemo-protection	2	62x14 cm	80	Trilaminate

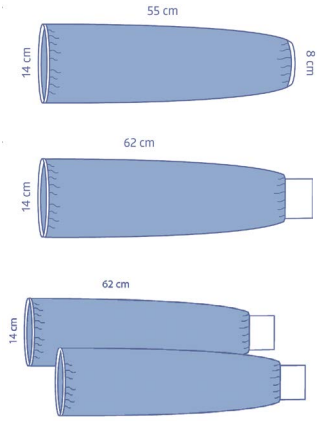

### Armcovers

Item order	Component	Component description	Comp qty.	Size	Qty/cs	Material
9460CE	9460	Armboard cover	2	76x36 CM	34	Spunlace

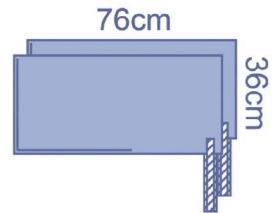

### Stool cover

Item order	Component	Component description	Size	Qty/cs	Material
DYJPECHCEC*	CHCEC	Stool cover	14x38 cm	30	Spunlace
ES304070CE	ES304070	Stool cover	75x75 cm	80	Bilaminate

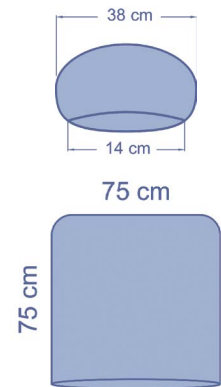

\*Delivered in wrap

## Maternity ball

Item order	Component	Component description	Size	Qty/cs	Material
SPT-ESBB01	SPT-ESBB01	Birthing ball cover, with elastic	140 CM diam.	96	Bilaminate

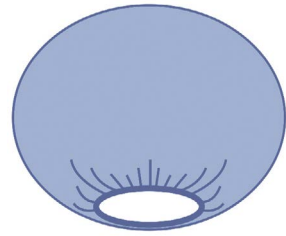

## Baby blanket

Item order	Component	Component description	Comp qty.	Size	Qty/cs	Material
1001CEB*	A75306	Soft baby blanket, sterile	1	100x105 cm	50	Spunlace
SPT-1001	A75306	Soft baby blanket, non-sterile	1	100x105 cm	40	Spunlace

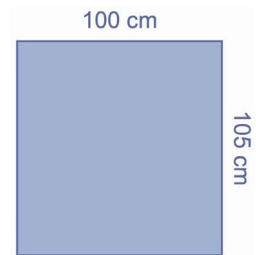

## Dislocation pouch\*

Item order	Component	Component description	Size	Qty/cs	Material
CP8691CE	F8692	Dislocation pouch, adhesive	110x77 cm	80	PE

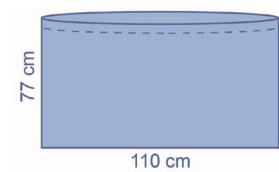

## Perineal cover\*

Item order	Component	Component description	Size	Qty/cs	Material
ES3007CE	ES3007	Perineal sheet, adhesive	37,5x16 cm	200	Bilaminate
TB3007CE	TB3007	Perineal sheet, adhesive	37,5x16 cm	300	Trilaminate



\*Delivered in wrap



**Choose your  
protection**





**ALWAYS  
ON.**

**Medline Industries Singapore Pte Ltd**  
70 Shenton Way # 19-10  
Singapore 079118  
+65 6214 0215  
[GMB-SEA-Customers@medline.com](mailto:GMB-SEA-Customers@medline.com)

**Medline Industries Malaysia Sdn Bhd**  
18-12 Menara Q Sentral,  
2A Jalan Stesen Sentral 2,  
Kuala Lumpur, Malaysia 50470  
[GMB-SEA-Customers@medline.com](mailto:GMB-SEA-Customers@medline.com)

Surgical Gowns and Surgical Drapes are Class I sterile medical device intended to be used by healthcare professionals. Before use, consult instructions and precautions on the corresponding labelling. Wound ring protectors are Class IIa sterile medical devices intended to be used by healthcare professionals. We reserve the right to correct any errors that may occur within this brochure.  
© 2023 Medline Industries, LP. Medline is a registered trademark of Medline Industries, LP.  
MKT19W4729939 / eSEA009 / 82

 Medline International France SAS  
5 Rue Charles Lindbergh  
44110 Châteaubriant, France

 2797 (BSI - The Netherlands)