

Invisishield™ Drapes

Unique products to help improve safety and patient care

Overview

Medline's Invisishield specialty drapes are designed to make the clinician's job easier while improving safety for both patients and staff.

INVISISHIELD PATIENT DRAPES

Medline's Invisishield drapes are clear so clinicians can easily see theatre equipment and the incision area. The impervious, tear-resistant material provides exceptional protection and offers superb drapeability.

CLEAR, IMPERVIOUS AND DRAPEABLE

Configurations for all major procedures and applications can be found in each section of our different Invisishield patient drapes.

- Transparent – Clinicians can easily view the area around incision sites.
- Impervious – Made of tear-resistant polyethylene and polyurethane films, Invisishield drapes provide superb protection from fluids.
- Drapeable – Invisishield drapes have just the right amount of flexibility and softness for superb drapeability.

USEFUL FEATURES

Invisishield drapes have handy features that help make the clinician's job easier. Our fluid pouches feature handy tabs on the adhesive liner that make removal easy. Capped, closable ports eliminate the need to cut or pierce the pouch for drainage, improving fluid control and reducing setup times.

INVISISHIELD	
General Accessories	3-6
Orthopaedic Drapes	7-9
Ophthalmic Drapes	10-12
Other Drapes	13
Dermadine® and Dermadrape® Incise Drapes	14
Equipment Drapes	15-21
CROSS REFERENCE	
Cross Reference	22-23

General Accessories

TOWEL DRAPES

DESCRIPTION

- Strong adhesive with no residue
- Non-linting, tear-resistant, poly-release liner
- Strong, drapeable, low-glare matte-finish film

USE

Prepping, tourniquet and instrument cover, squaring off, isolating sterile from non-sterile areas, fluid barrier, non-linting surface

Item No.	Dimensions	Pkg.
IDE1000	45 x 30 cm Adhesive only: 45 x 5.1 cm	10 ea/bx; 40 ea/cs
IDE1010	45 x 61 cm Adhesive only: 45 x 5.1 cm	10 ea/bx; 40 ea/cs



Easy-peel liner: less force is needed to separate it from the adhesive section. The reinforced adhesive section reduces the chance of wrinkling.

General Accessories

ISOLATION BAGS

DESCRIPTION

- Soft, strong, clear film with seamless bottom
- Cotton drawstrings for easy closure
- Cuffed opening to improve sterile delivery

USE

Isolate foot, hand, non-linting surface

Item No.	Dimensions	Pkg.
ICE1003	50 x 50 cm	10 ea/bx; 40 ea/cs

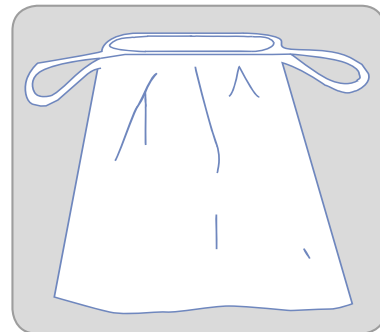

FLUID POUCHES WITH DRAINAGE PORTS

DESCRIPTION

- Wide adhesive area for better adhesion
- Strong adhesive with no residue
- Non-linting, tear-resistant, waxy paper release liner
- Mouldable strip to enhance pouch performance
- Micro screen for improved filtering system
- Suction port with cap for improved fluid control
- Heavy, low-glare matte-finish film

USE

CV, orthopaedic, neurology, urology, general

Item No.	Dimensions	Pkg.
IDE1016	50 x 50 cm Adhesive only: 50 x 15 cm	40 ea/cs



Extra-long mouldable strip allows for customisation.

General Accessories

INSTRUMENT POUCHES

DESCRIPTION

- 2 compartments for cauteries or catheters
- New high-tack, aggressive adhesive for better adhesion to linen or non-woven materials
- Heavy, low-glare matte-finish film

USE

CV, orthopaedic, neurology

Item No.	Dimensions	Pkg.
IDE1018	17 x 29 cm Adhesive only (2): 17 x 3.8 cm	10 ea/bx; 40 ea/cs

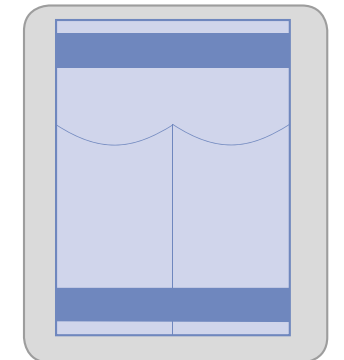

LONG INSTRUMENT POUCHES

DESCRIPTION

- 3 long compartments for cauteries or catheters
- New high-tack, aggressive adhesive for better adhesion to linen or non-woven materials
- Heavy, low-glare matte-finish film

USE

CV, orthopaedic, neurology

Item No.	Dimensions	Pkg.
IDE1018L	25 x 47 cm Adhesive only (2): 25 x 5 cm	10 ea/bx; 40 ea/cs

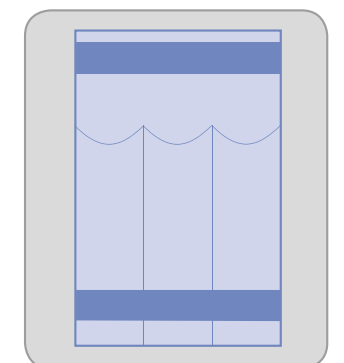

General Accessories

INSTRUMENT POUCHES

DESCRIPTION

- 1 large compartment for instruments
- New high-tack adhesive tape
- Clear, strong poly film

USE

CV, orthopaedic, neurology, general

Item No.	Dimensions	Pkg.
DYJPEISTPOM1	33 x 41 cm Adhesive only: 41 x 5 cm	100 ea/cs
DYJPEISTPOM2	33 x 41 cm Adhesive only: 41 x 5 cm	100 ea/cs
DYJPEISTPOM3	43 x 48 cm Adhesive (2): 43 x 5 cm	60 ea/cs

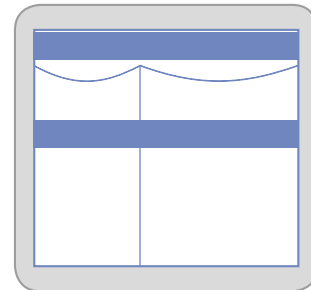
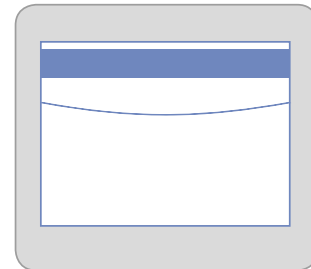
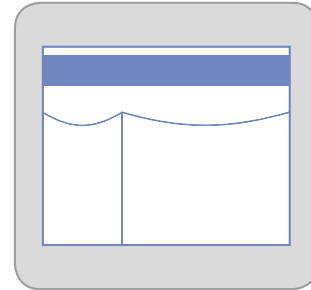

FLUID POUCHES

DESCRIPTION

- Strong adhesive with no residue
- Non-linting, tear-resistant, waxy paper release liner
- Mouldable strip to enhance pouch performance

USE

ENT, general

Item No.	Dimensions	Pkg.
DYNJSD2114	30.5 x 27.9 cm Adhesive only: 30.5 x 2.5 cm	10 ea/bx; 40 ea/cs

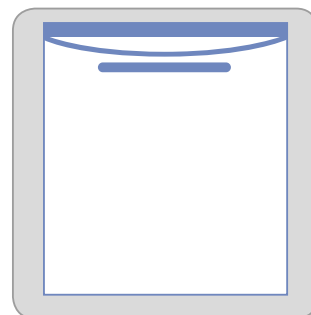

Orthopaedic Drapes

POLY U DRAPES

DESCRIPTION

- 'U' fenestration with wide adhesive area
- Advanced adhesive providing excellent adhesion without residue
- Strong, drapeable, low-glare matte-finish film
- Split, wax paper liner for ease of application

USE

Prepping procedures: arthroscopies, hip, knee, shoulder, back, cranial, isolation and applications

Item No.	Dimensions	Pkg.
IDE1015	121 x 132 cm Adhesive only: 25 x 48 cm	10 ea/bx; 40 ea/cs
IDE1019	121 x 180 cm Adhesive only: 25 x 48 cm 'U' fenestration only: 15 x 48 cm	10 ea/bx; 40 ea/cs



These drapes include courtesy tabs for easy removal.

SHOULDER POUCHES

DESCRIPTION

- Oval aperture with slit and adhesive areas
- Strong adhesive with no residue
- Heavy, low-glare matte-finish film for additional strength
- 2 mouldable strips and 1 foam strip to enhance pouch performance
- 2 suction ports with caps for improved fluid control

USE

Shoulder arthroscopy, implant applications

Item No.	Dimensions	Pkg.
DYNJSD1067	91 x 73 cm Adhesive only: 25 x 48 cm Aperture: 19 x 25 cm	24 ea/cs

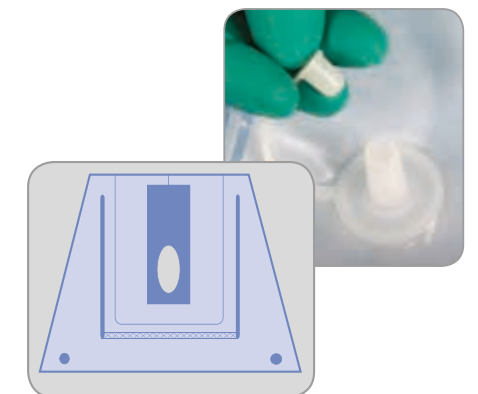

The capped, closable port eliminates the step of cutting or piercing for drainage and makes it easy to stop the flow at the end of the procedure.

Orthopaedic Drapes

U FLUID COLLECTION POUCHES

DESCRIPTION

- 'U' aperture with adhesive area
- Strong adhesive with no residue
- 3 mouldable strips to enhance pouch performance
- Strong, drapeable, clear poly film

USE

Shoulder arthroscopy, hip surgery, orthopaedic

Item No.	Dimensions	Pkg.
DYJPEFP090	76 x 112 cm Adhesive only: 25 x 51 cm Aperture: 15 x 46 cm	25 ea/cs

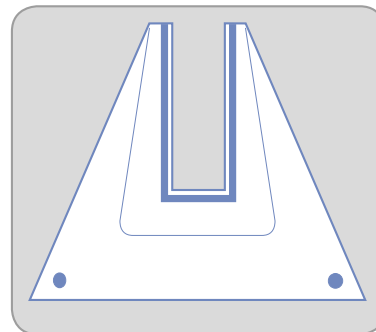

PATIENT ISOLATION DRAPES

DESCRIPTION

- Less aggressive adhesive strip for easy removal
- Aggressive incise adhesive with no residue
- Clear, strong poly film

USE

Hip pinning

Item No.	Dimensions	Pkg.
DYNJSD1014	317 x 213 cm Adhesive only: 49 x 25 cm Adhesive strip only: 317 x 1.3 cm	5 ea/bx; 15 ea/cs

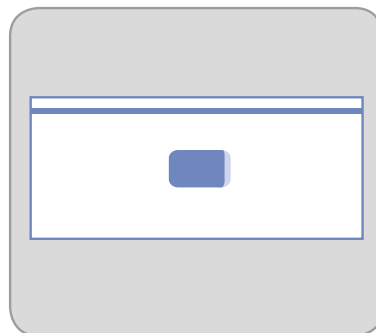

Orthopaedic Drapes

PATIENT ISOLATION DRAPES WITH POUCH

DESCRIPTION

- Strong incise adhesive with no residue
- Clear, strong poly film
- 2 cord holders and instrument pouches for better organisation
- Large pouch with micro screen, suction port and cap for improved fluid control

USE

Hip pinning, nephroscopies, biliaries

Item No.	Dimensions	Pkg.
DYNJSD1017	317 x 213 cm Adhesive only: 49 x 25 cm Adhesive strip only: 317 x 1.3 cm Pouch only: 51 x 51 cm	15 ea/cs
DYNJSD1017W	317 x 254 cm Adhesive only: 85.1 x 27.9 cm Adhesive strip only: 317 x 1.3 cm Pouch only: 69.9 x 94 cm	15 ea/cs

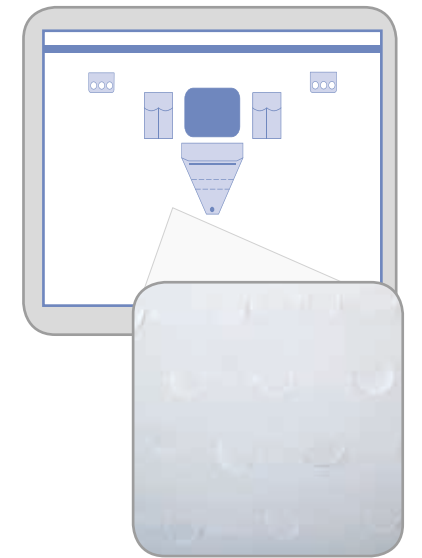

These drapes have a superb filter with deep placement for quick drainage and numerous small perforations.

Ophthalmic Drapes

APERTURE DRAPES

DESCRIPTION

- Circular aperture with adhesive area
- Non-linting, tear-resistant, wax paper release liner
- Thin, soft, drapeable, low-glare matte-finish film

USE

Cataract, corneal, refractive, lid/plastic, minor

Item No.	Dimensions	Pkg.
IDE1020	40 x 40 cm Adhesive only: 12 x 12 cm Aperture only: 6 cm circle	10 ea/bx; 40 ea/cs

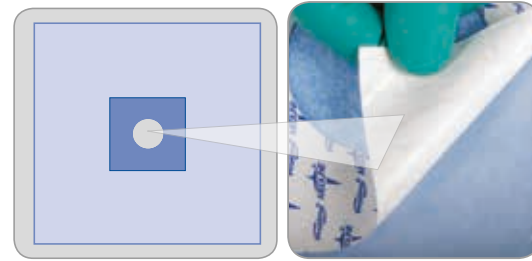

Easy-peel liner: less force is needed to separate it from the adhesive section.

OPHTHALMIC DRAPES

DESCRIPTION

- Incise adhesive area optimised for skin
- Non-linting, tear-resistant, wax paper release liner
- 2 adhesive tabs for additional support
- Mouldable strip for additional fluid control
- Soft, drapeable, low-glare matte-finish film

USE

Cataract, vitreoretinal, corneal

Item No.	Dimensions	Pkg.
IDE1023	48 x 41 cm Adhesive only: 12 x 10 cm Adhesive tabs only: 5 x 5 cm	10 ea/bx; 40 ea/cs

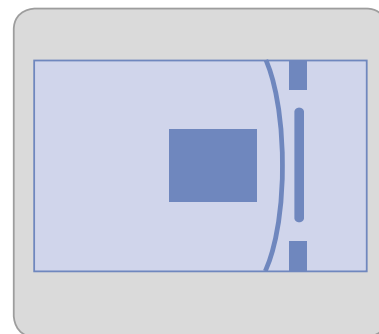

Ophthalmic Drapes

OPHTHALMIC APERTURE POUCHES

DESCRIPTION

- Oval aperture with adhesive optimised for skin
- Non-linting, tear-resistant, wax paper release liner
- 2 adhesive tabs for additional support
- Mouldable strip for additional fluid control
- Soft, drapeable, low-glare matte-finish film

USE

Cataract, vitreoretinal, corneal

Item No.	Dimensions	Pkg.
IDE1024	48 x 41 cm Adhesive only: 6 x 3.5 cm Adhesive tabs only: 5 x 5 cm Aperture only: 6 x 3.5 cm	10 ea/bx; 40 ea/cs

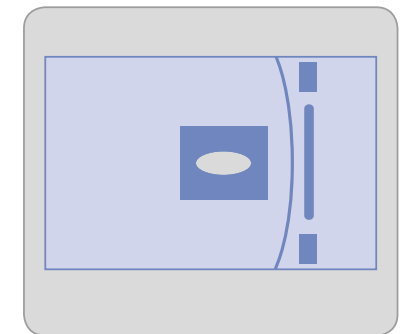

APERTURE DRAPES

DESCRIPTION

- Oval aperture with adhesive area
- Non-linting, tear-resistant, wax paper release liner
- Soft, drapeable, low-glare matte-finish film

USE

Cataract, vitreoretinal, corneal, lid/plastic, ENT

Item No.	Dimensions	Pkg.
IDE1030	83 x 129 cm Adhesive only: 12 x 11 cm Aperture only: 7 x 5 cm	10 ea/bx; 40 ea/cs

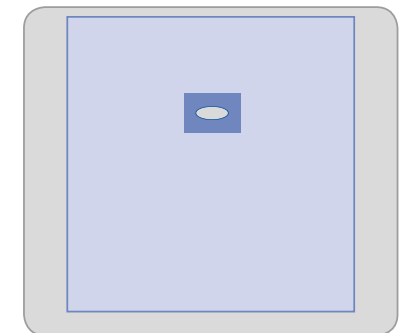

Ophthalmic Drapes

OPHTHALMIC INCISE DRAPES WITH FLUID POUCH

DESCRIPTION

- Incise adhesive area
- Non-linting, tear-resistant, wax paper release liner
- Fluid pouch with mouldable strip for additional fluid control
- Soft, drapeable, low-glare matte-finish film

USE

Cataract, vitreoretinal

Item No.	Dimensions	Pkg.
IDE1061	121 x 129 cm Adhesive only: 12 x 11 cm Pouch only: 30 x 27 cm	10 ea/bx; 40 ea/cs

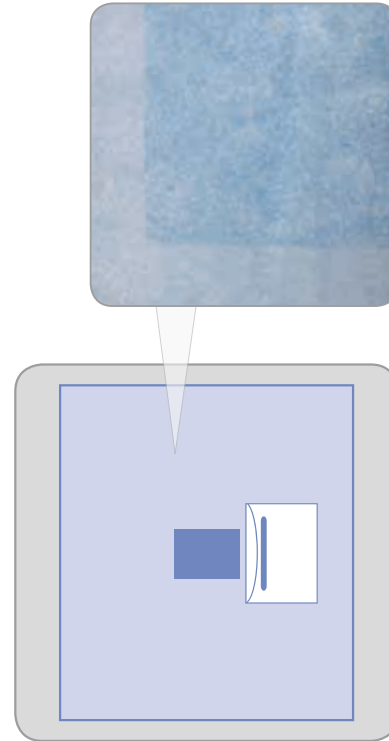

UROLOGICAL DRAPES

DESCRIPTION

- Strong adhesive with no residue
- Latex-free finger cot
- Strong, low-glare matte-finish film
- Non-linting, tear-resistant, wax paper release liner

USE

TUR, urology, gynaecology

Item No.	Dimensions	Pkg.
IDE1071	60 x 91 cm Adhesive only: 60 x 5 cm Finger cot adhesive only: O.D. 10 x I.D. 3 cm	10 ea/bx; 40 ea/cs

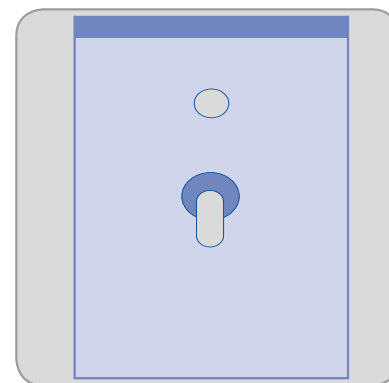

Other Drapes

APERTURE POUCHES

DESCRIPTION

- Oval aperture with large adhesive area
- Strong adhesive with no residue
- Mouldable strip for additional fluid control
- Heavy, low-glare matte-finish film

USE

Vaginal, ophthalmic

Item No.	Dimensions	Pkg.
IDE1072	45 x 22 cm Adhesive only: 30 x 22 cm Aperture only: 11 x 9 cm	10 ea/bx; 40 ea/cs

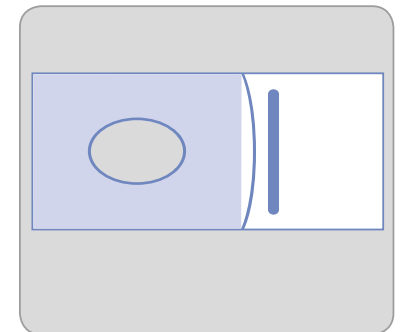

CESAREAN POUCHES

DESCRIPTION

- High-moisture permeable incise film for extended adhesion
- Strong adhesive with no residue
- Large-cell foam to provide fluid control
- 360° fluid pouch for complete fluid containment
- 2 cord holders for line organisation
- Heavy, low-glare matte-finish film for additional pouch strength

USE

C-section, trauma, general

Item No.	Dimensions	Pkg.
DYNJSD2057	91 x 76 cm Adhesive only: 38 x 36 cm	10 ea/cs

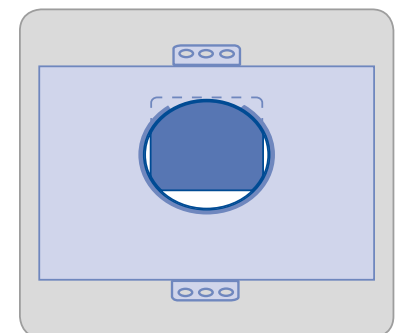

Dermadine® and Dermadrape® Incise Drapes

DESCRIPTION

- Thin, conformable, low-glare matte-finish film
- Strong adhesive with no residue
- Breathable, water-repellent and waterproof
- Comfortable and enveloping
- Long-lasting incise drapes
- Dermadine incise drapes: impregnated with an antibacterial solution
- Dermadrape drapes: clear incise drapes



Dermadine® Item No.		Dimensions	Pkg.	Dermadrape® Item No.	
42020		20 x 20 cm Adhesive: 15 x 20 cm	20 ea/bx 120 ea/cs	32020	
n/a		35 x 25 cm Adhesive: 30 x 25 cm	20 ea/bx 120 ea/cs	33525	
44040		40 x 40 cm Adhesive: 34 x 40 cm	15 ea/bx 90 ea/cs	34040	
n/a		50 x 48 cm Adhesive: 44 x 48 cm	15 ea/bx 90 ea/cs	35050	
47045		70 x 45 cm Adhesive: 60 x 45 cm	15 ea/bx 90 ea/cs	37045	
48060		80 x 60 cm Adhesive: 60 x 60 cm	10 ea/bx 60 ea/cs	38060	
48080		80 x 80 cm Adhesive: 70 x 80 cm	10 ea/bx 60 ea/cs	38080	

Equipment Drapes

CIRCULAR BANDED BAGS

DESCRIPTION

- Clear, drapeable poly film
- Latex-free elastic bands
- Versatile, often used to cover intensifiers and other equipment

Item No.	Dimensions	Pkg.
ICE60020S	25 x 55 cm	25 ea/cs
ICE60028S	35 x 70 cm	25 ea/cs
ICE60030S	40 x 80 cm	25 ea/cs
ICE60040S	50 x 100 cm	25 ea/cs
ICE60050S	60 x 120 cm	25 ea/cs
ICEBBG070	65 x 130 cm	50 ea/cs

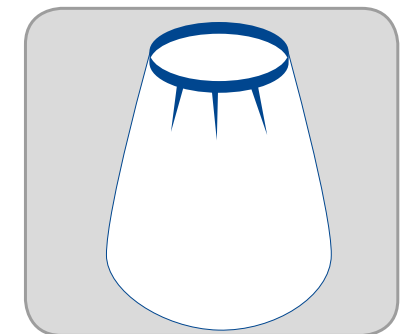

RECTANGULAR BANDED BAGS

DESCRIPTION

- Clear, drapeable poly film
- Latex-free elastic bands
- Versatile, often used to cover intensifiers and other equipment

Item No.	Dimensions	Pkg.
ICE63036R	76 x 91 cm	25 ea/cs
ICE63628R	91 x 71 cm	25 ea/cs
ICE63636R	91 x 91 cm	25 ea/cs
ICEBBG095	95 x 85 cm	25 ea/cs
ICE63654S	95 x 130 cm	25 ea/cs
ICE64848S	122 x 122 cm	25 ea/cs

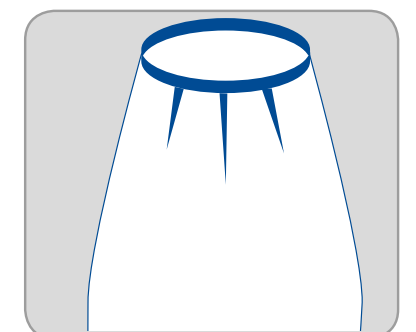

Equipment Drapes

C-ARM SET PHILIPS

DESCRIPTION

- Clear banded bags for X-ray tank/intensifier
- Clear poly drape to cover the C-arm

DYNJE4526 for BV29/300
 DYNJE4527 for BV300
 DYNJE4530 for BV25/26
 DYNJE4569 for Pulsera/Endura

Item No.	Dimensions	Pkg.
DYNJE4526	Banded bags: 60 x 115 cm 70 x 130 cm C-arm cover: 30 x 198 cm	10 ea/bx; 20 ea/cs
DYNJE4527	Banded bags: 60 x 115 cm rect.: 95 x 85 cm C-arm cover: 30 x 198 cm	10 ea/bx; 20 ea/cs
DYNJE4530	Banded bags: 60 x 115 cm C-arm cover: 30 x 198 cm	10 ea/bx; 20 ea/cs
DYNJE4569	Banded bags: 60 x 115 cm 70 x 140 cm C-arm cover: 30 x 198 cm	10 ea/bx; 20 ea/cs

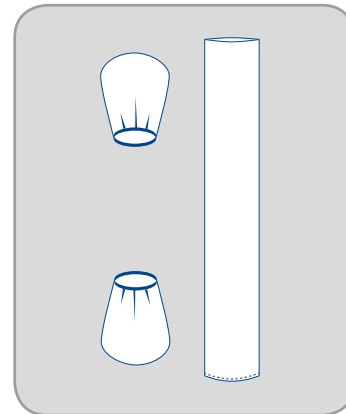

C-ARM SET ZIEHM

DESCRIPTION

- Clear banded bags for X-ray tank/intensifier
- Clear poly drape to cover the C-arm

For starter set SPTE-SS634

Item No.	Dimensions	Pkg.
DYNJE4531	Banded bags: 60 x 115 cm 70 x 130 cm C-arm cover: 35 x 185 cm	10 ea/bx; 20 ea/cs

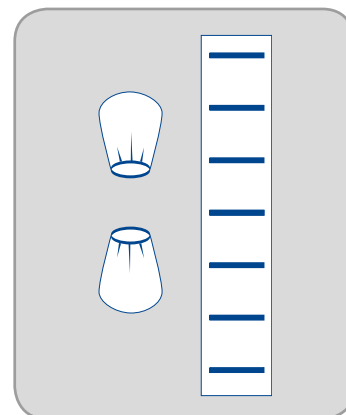

Equipment Drapes

C-ARM SET SIEMENS

DESCRIPTION

- Clear banded bags for X-ray tank/intensifier
- Clear poly drape to cover the C-arm

DYNJE4532 for SIREMOBIL N4
 DYNJE4547 for SIREMOBIL 2000

Clear poly drape with clips for starter set SPTE-SS628

DYNJE4556 for ISO-C/Arcadis/Orbic, 2 parts

DYNJE4557 for ISO-C/Arcadis/Orbic, 1 part

Item No.	Dimensions	Pkg.
DYNJE4532	Banded bags: 60 x 115 cm 60 x 115 cm C-arm cover: 35 x 183 cm	10 ea/bx; 20 ea/cs
DYNJE4556	Top: 51-82 x 130 cm Bottom: 53-46 x 134 cm	10 ea/bx; 20 ea/cs
DYNJE4557	Top: 51-82 x 130 cm	10 ea/bx; 20 ea/cs

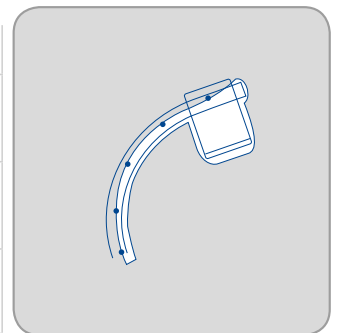
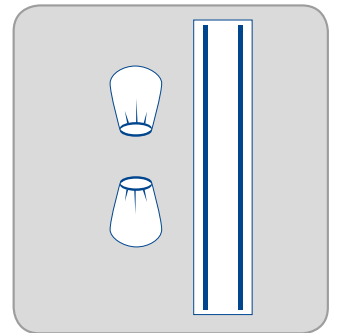

FLUOROSCOPE DRAPES

DESCRIPTION

- 2 adhesive strips for attachment, with 2 adhesive tabs for proper fit
- Clear, drapeable poly film

Item No.	Dimensions	Pkg.
ICE1012	91 x 111 cm Adhesive only (2): 91 x 1.2 cm Adhesive tabs only: 5 x 10 cm	10 ea/bx; 40 ea/cs

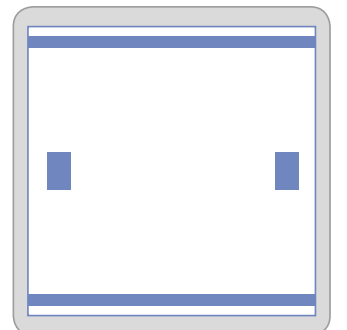

Equipment Drapes

FULL-SIZE C-ARM DRAPES

DESCRIPTION

- 3 adhesive poly straps for securement
- Clear, drapeable poly film

ICE4400R: has 2 latex-free elastic bands for additional securement

Item No.	Dimensions	Pkg.
ICE4400	104 x 188 cm	20 ea/cs
ICE4400R	104 x 188 cm	20 ea/cs

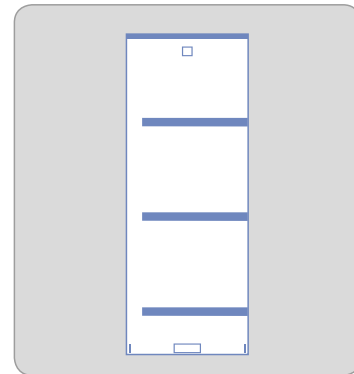

CONTOURED C-ARM DRAPES

DESCRIPTION

- 4 adhesive poly straps for securement
- Clear, drapeable poly film
- Contoured to fit full C-arm

Item No.	Dimensions	Pkg.
ICE4430	152 x 267 cm	20 ea/cs

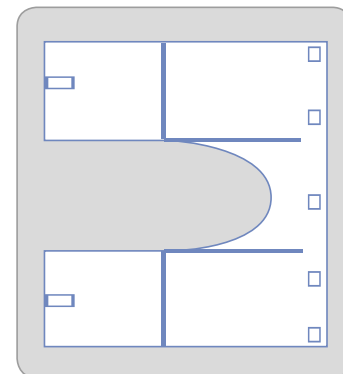

MINI C-ARM DRAPES

DESCRIPTION

- Held in place with an elastic band on the back
- 3 adhesive poly straps for additional securement
- Clear, drapeable poly film

ICE4410: fits Fluoroscan® mini C-arm models

ICE4420: fits Fluoroscan® and OEC6600/6800 mini C-arm models

Item No.	Dimensions	Pkg.
ICE4410	137 x 160 cm	20 ea/cs
ICE4420	137 x 216 cm	20 ea/cs

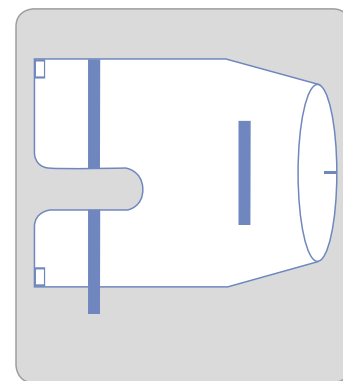

Equipment Drapes

FULL-SIZE C-ARM KITS

DESCRIPTION

- Clear, drapeable poly film
- Latex-free bands

Item No.	Dimensions	Pkg.
ICE4500	Intensifier drape (1): 91 x 91 cm C-Arm drape (1): 41 x 218 cm Footswitch drape (1): 46 x 41 cm Banded bag (1): 71 x 31 cm	20 ea/cs

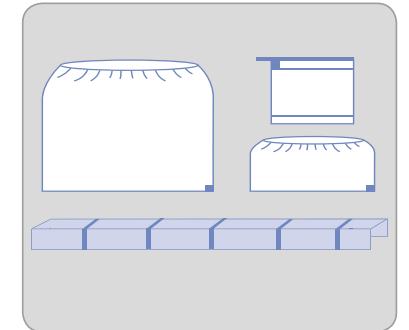

REMOTE CONTROL COVERS

DESCRIPTION

- Clear poly film bag
- Pinch-top closure

Item No.	Dimensions	Pkg.
DYNJE4635	10 x 28 cm	50 ea/bx; 200 ea/cs
DYNJE4641	18 x 35 cm	50 ea/bx; 200 ea/cs

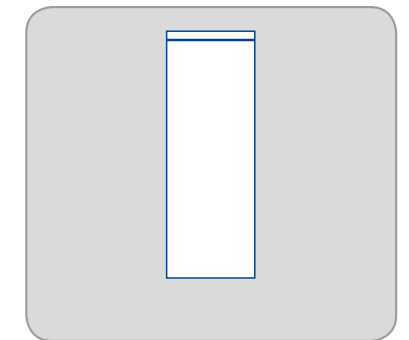

VIDEO CAMERA COVERS

DESCRIPTION

- Adhesive poly strap for holding it in place
- Adhesive strip at base for additional securement
- Clear, drapeable poly film
- Cable cover

Item No.	Dimensions	Pkg.
ICE4250	13 x 244 cm reverse	25 ea/cs
ICE4300	23 x 244 cm reverse	25 ea/cs
ICE4240	13 x 240 cm telescopic with tab	25 ea/cs
ICE4260	15 x 240 cm with ring	25 ea/cs
ICE4270	14 x 244 cm concertina	25 ea/cs
ICE4200	18 x 244 cm elastic end	25 ea/cs
ICE4100	8 x 200 cm telescopic with tab	25 ea/cs

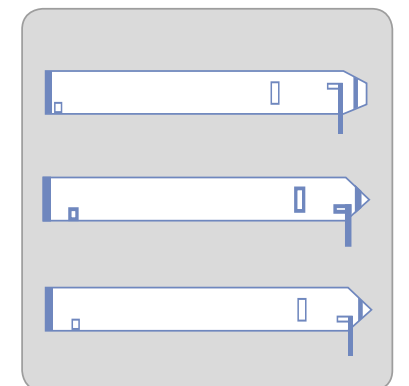

Equipment Drapes

MICROSCOPE DRAPES

DESCRIPTION

- All fitted with clear, drapeable poly film

ICE5010, ICE5040

- Fits 48 mm lens (Zeiss® OPMI)
- 3 adhesive poly straps for securement
- Fits 1 pair of oculars

ICE5200, ICE5210, ICE5030

- Fits 65 mm lens (Zeiss® MD)
- 3 adhesive poly straps for securement
- Fits 3 pairs of oculars

ICE5220

- Fits 65 mm lens (Zeiss® MD)
- 5 adhesive poly straps for securement
- Fits 3 pairs of oculars

ICE5300, ICE5330

- Fits 68 mm lens (Leica®)
- 3 adhesive poly straps for securement
- Fits 3 pairs of oculars

Item No.	Dimensions	Pkg.
Fits 48 mm lens (Zeiss® OPMI)		
ICE5010	51 x 163 cm	20 ea/cs
ICE5040	51 x 267 cm	40 ea/cs
Fits 65 mm lens (Zeiss® MD)		
ICE5200	117 x 203 cm	10 ea/cs
ICE5030	117 x 305 cm	10 ea/cs
ICE5210	117 x 267 cm	10 ea/cs
ICE5220	137 x 381 cm	10 ea/cs
Fits 68 mm lens (Leica®)		
ICE5300	104 x 163 cm	10 ea/cs
ICE5320	137 x 267 cm	10 ea/cs
ICE5330	137 x 381 cm	10 ea/cs

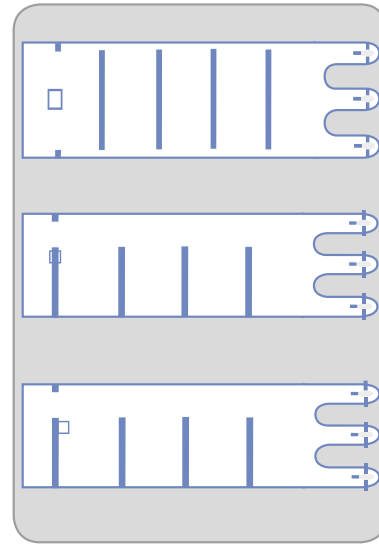

Equipment Drapes

X-RAY CASSETTE COVERS

DESCRIPTION

- Clear, drapeable poly film

ICE4010: release liner for facilitating sterile technique

Item No.	Dimensions	Pkg.
ICE4000	Large: 61 x 102 cm	20 ea/cs
ICE5200	Standard with liner: 61 x 64 cm	48 ea/cs
ICE4050	Standard: 61 x 64 cm	50 ea/cs

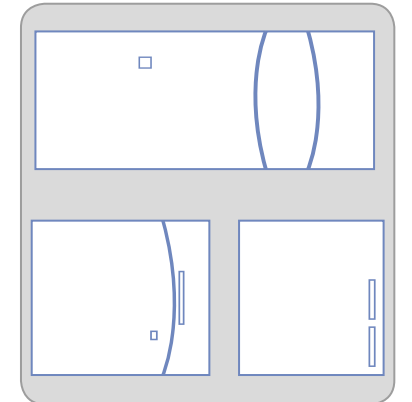

PROBE COVER KITS

DESCRIPTION

- Components
 - Probe cover (1)
 - Ultrasound gel packet (1)
 - Elastic bands (2)
- High-quality, sterile ultrasound gel for transducer
- 2 elastic bands for securement
- Soft, drapeable, poly film

Item No.	Dimensions	Pkg.
ICE5900	10 x 122 cm	20 ea/cs
ICE5910	15 x 61 cm	20 ea/cs
ICE5920	15 x 122 cm	20 ea/cs
ICE5930	15 x 244 cm	20 ea/cs



High-quality polyurethane is soft and drapeable to conform to the transducer and has a smooth finish for easy application and glide. The slightly matte surface helps prevent glare.

THERMO COVER

DESCRIPTION

- Clear poly film
- Aluminium coated foil
- Temperature resistance up to 60° C

Item No.	Dimensions	Pkg.
DYNJE7000	68 x 86 cm	40 ea/cs

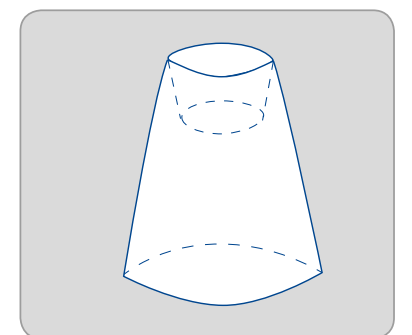

INVISISHIELD Cross Reference

PAGE	DESCRIPTION	PRODUCT NO. MEDLINE	PRODUCT NO. 3M®	PRODUCT NO. MICROTEK®
3	Towel drape	IDE1000	1000	ISO1000
4	Isolation bag	ICE1003	1003	ISO1003
3	Towel drape	IDE1010	1010	ISO1010
8	Patient isolation drape	DYNJSD1014	1014	n/a
7	Poly U drape	IDE1015	1015	ISO1015
4	Fluid pouch	IDE1016	1016	ISO1016
9	Patient isolation drape	DYNJSD1017	1017	5960
9	Wide patient isolation drape	DYNJSD1017W	n/a	6960
5	Instrument pouch	IDE1018	1018	ISO1018
5	Long instrument pouch	IDE1018L	1018L	n/a
7	Poly U drape	IDE1019	1019	ISO1019
10	Aperture drape	IDE1020	1020	ISO1020
10	Ophthalmic incise drape	IDE1023	1023	n/a
11	Ophthalmic aperture pouch	IDE1024	1024	ISO1024
11	Aperture drape	IDE1030	1030	ISO1030
14	Incise drape	32020	1035	ISO1035
14	Incise drape	34040	1040	ISO1040
14	Incise drape	37045	1050	ISO1050
14	Incise drape	38080	1051	ISO1051
12	Ophthalmic incise drape with fluid pouch	IDE1061	1061	ISO1061
7	Shoulder pouch	DYNJSD1067	1067	ISO1067
12	Urological drape	IDE1071	1071	ISO1071
13	Aperture pouch	IDE1072	1072	ISO1072
8	U fluid collection pouch	DYJPEFP090	n/a	n/a
6	Instrument pouch	DYJPEISTPOM1	n/a	n/a
6	Instrument pouch	DYJPEISTPOM2	n/a	n/a
6	Instrument pouch	DYJPEISTPOM3	n/a	n/a

All products are  latex free and sterile, unless indicated in the description.



Dermadine® Cross Reference

TYPE OF FILM	DESCRIPTION	PRODUCT NO. MEDLINE	PRODUCT NO. 3M®
PU	Drape Incise Sterile 15 x 20 cm ~ Incise Area 10 x 20 cm Iodophor Impregnated	42020	6635
PU	Drape Incise Sterile 44 x 35 cm ~ Incise Area 34 x 35 cm Iodophor Impregnated	44040	6640
PU	Drape Incise Sterile 66 x 60 cm ~ Incise Area 56 x 60 cm Iodophor Impregnated	48060	6648
PU	Drape Incise Sterile 66 x 45 cm ~ Incise Area 56 x 45 cm Iodophor Impregnated	47045	6650
PU	Drape Incise Sterile 66 x 85 cm ~ Incise Area 56 x 85 cm Iodophor Impregnated	48080	6651
PU with applicator	Drape Incise Sterile 30 x 20 cm ~ Incise Area 26 x 20 cm Iodophor Impregnated	42020	6661EZ
PU with applicator	Drape Incise Sterile 60 x 35 cm ~ Incise Area 35 x 35 cm Iodophor Impregnated	44040	6640EZ
PU with applicator	Drape Incise Sterile 90 x 60 cm ~ Incise Area 60 x 60 cm Iodophor Impregnated	48060	6648EZ
PU with applicator	Drape Incise Sterile 90 x 45 cm ~ Incise Area 60 x 45 cm Iodophor Impregnated	47045	6650EZ
PU with applicator	Drape Incise Sterile 90 x 85 cm ~ Incise Area 60 x 85 cm Iodophor Impregnated	48080	6651EZ

Dermadrape® Cross Reference

TYPE OF FILM	DESCRIPTION	PRODUCT NO. MEDLINE	PRODUCT NO. 3M®
PE	Drape Incise Sterile 15 x 20 cm ~ Incise Area 10 x 20 cm	32020	1035
PE	Drape Incise Sterile 29 x 25 cm ~ Incise Area 19 x 25 cm	32020	1037
PE	Drape Incise Sterile 60 x 35 cm ~ Incise Area 35 x 35 cm	34040	1040
PE	Drape Incise Sterile 82 x 45 cm ~ Incise Area 60 x 45 cm	37045	1050
PE	Drape Incise Sterile 82 x 85 cm ~ Incise Area 60 x 85 cm	38080	1051
PU	Drape Incise Sterile 20 x 20 cm ~ Incise Area 10 x 20 cm	32020	2035
PU	Drape Incise Sterile 38 x 25 cm ~ Incise Area 28 x 25 cm	33525	2037
PU	Drape Incise Sterile 38 x 41 cm ~ Incise Area 28 x 41 cm	34040	2040
PU	Drape Incise Sterile 60 x 45 cm ~ Incise Area 50 x 45 cm	35050	2045
PU	Drape Incise Sterile 90 x 60 cm ~ Incise Area 60 x 60 cm	38060	2050
PU	Drape Incise Sterile 90 x 85 cm ~ Incise Area 60 x 85 cm	38080	2051



For more information about our products please visit:
www.medline.eu/uk or contact your local account manager.



**ALWAYS
ON.**

Medline Industries Ltd
3rd Floor
Quayside Wilderspool Business Park
Greenalls Avenue
Warrington WA4 6HL
United Kingdom
Tel.: +44 844 334 5237
Fax: +44 844 334 5238
www.medline.eu/uk
uk-customerservice@medline.com

We reserve the right to correct any errors that may occur within this brochure.
© 2018 Medline Industries, Inc. Medline is a registered trademark of Medline Industries, Inc. Three Lakes Drive, Northfield, IL 60093, USA.
ML164-EN05/CG/MM 11/2018.

Dermadine® and Dermadrape® are class IIa sterile medical devices.

All other products listed are class I sterile medical devices.

These products are intended to be used by healthcare professionals. Before use, consult instructions and precautions on the corresponding labelling.



CE 0373 Istituto Superiore di Sanità



CE 0086 (BSI)