

## **Invisishield™ Drapes**

Unique products to help improve safety and patient care

# Overview

Medline's Invisishield specialty drapes are designed to make the clinician's job easier while improving safety for both patients and staff.

## INVISISHIELD PATIENT DRAPES

Medline's Invisishield drapes are clear so clinicians can easily see theatre equipment and the incision area. The impervious, tear-resistant material provides exceptional protection and offers superb drapeability.

### CLEAR, IMPERVIOUS AND DRAPEABLE

Configurations for all major procedures and applications can be found in each section of our different Invisishield patient drapes.

- Transparent – Clinicians can easily view the area around incision sites.
- Impervious – Made of tear-resistant polyethylene and polyurethane films, Invisishield drapes provide superb protection from fluids.
- Drapeable – Invisishield drapes have just the right amount of flexibility and softness for superb drapeability.

### USEFUL FEATURES

Invisishield drapes have handy features that help make the clinician's job easier. Our fluid pouches feature handy tabs on the adhesive liner that make removal easy. Capped, closable ports eliminate the need to cut or pierce the pouch for drainage, improving fluid control and reducing setup times.

#### INVISISHIELD

General Accessories	3-6
Orthopaedic Drapes	7-10
Ophthalmic Drapes	10-12
Other Drapes	12-13
Dermadine® and Dermadrape® Incise Drapes	14
Equipment Drapes	15-21

#### CROSS REFERENCE

Cross Reference	22-23
-----------------	-------

# General Accessories

## TOWEL DRAPES

### DESCRIPTION

- Strong adhesive with no residue
- Non-linting, tear-resistant, poly-release liner
- Strong, drapeable, low-glare matte-finish film

### USE

Prepping, tourniquet and instrument cover, squaring off, isolating sterile from non-sterile areas, fluid barrier, non-linting surface

Item No.	Dimensions	Pkg.
IDE1000	45 x 30 cm Adhesive only: 45 x 5.1 cm	10 ea/bx; 40 ea/cs
IDE1010	45 x 61 cm Adhesive only: 45 x 5.1 cm	10 ea/bx; 40 ea/cs



Easy-peel liner: less force is needed to separate it from the adhesive section. The reinforced adhesive section reduces the chance of wrinkling.

# General Accessories

## ISOLATION BAGS

### DESCRIPTION

- Soft, strong, clear film with seamless bottom
- Cotton drawstrings for easy closure
- Cuffed opening to improve sterile delivery

### USE

Isolate foot, hand, non-linting surface

Item No.	Dimensions	Pkg.
ICE1003	50 x 50 cm	10 ea/bx; 40 ea/cs

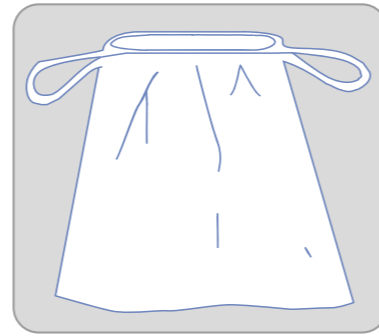

## FLUID POUCHES WITH DRAINAGE PORTS

### DESCRIPTION

- Wide adhesive area for better adhesion
- Strong adhesive with no residue
- Non-linting, tear-resistant, waxy paper release liner
- Mouldable strip to enhance pouch performance
- Micro screen for improved filtering system
- Suction port with cap for improved fluid control
- Heavy, low-glare matte-finish film

### USE

CV, orthopaedic, neurology, urology, general

Item No.	Dimensions	Pkg.
IDE1016	50 x 50 cm Adhesive only: 50 x 15 cm	40 ea/cs

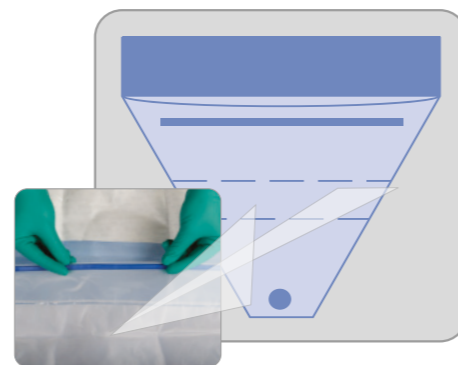

Extra-long mouldable strip allows for customisation.

# General Accessories

## INSTRUMENT POUCHES

### DESCRIPTION

- 2 compartments for cauteries or catheters
- New high-tack, aggressive adhesive for better adhesion to linen or non-woven materials
- Heavy, low-glare matte-finish film

### USE

CV, orthopaedic, neurology

Item No.	Dimensions	Pkg.
IDE1018	17 x 29 cm Adhesive only (2): 17 x 3.8 cm	10 ea/bx; 40 ea/cs

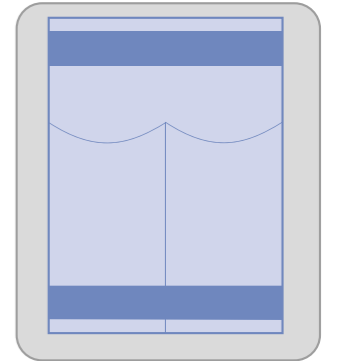

## LONG INSTRUMENT POUCHES

### DESCRIPTION

- 3 long compartments for cauteries or catheters
- New high-tack, aggressive adhesive for better adhesion to linen or non-woven materials
- Heavy, low-glare matte-finish film

### USE

CV, orthopaedic, neurology

Item No.	Dimensions	Pkg.
IDE1018L	25 x 47 cm Adhesive only (2): 25 x 5 cm	10 ea/bx; 40 ea/cs

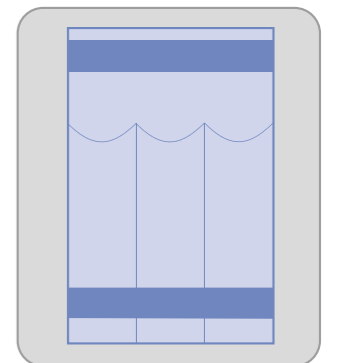

# General Accessories

## INSTRUMENT POUCHES

### DESCRIPTION

- 1 large compartment for instruments
- New high-tack adhesive tape
- Clear, strong poly film

### USE

CV, orthopaedic, neurology, general

Item No.	Dimensions	Pkg.
DYJPEISTPOM1	33 x 41 cm Adhesive only: 41 x 5 cm	100 ea/cs
DYJPEISTPOM2	33 x 41 cm Adhesive only: 41 x 5 cm	100 ea/cs
DYJPEISTPOM3	43 x 48 cm Adhesive (2): 43 x 5 cm	60 ea/cs
O4A040CE	33 x 51 cm Adhesive only: 51 x 5 cm	180 ea/cs

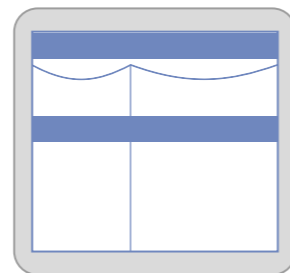
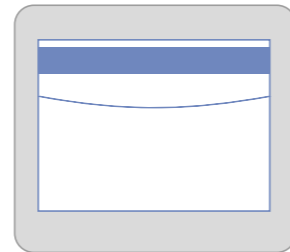
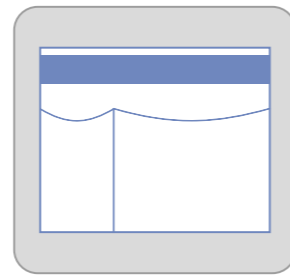

## FLUID POUCHES

### DESCRIPTION

- Strong adhesive with no residue
- Non-linting, tear-resistant, waxy paper release liner
- Mouldable strip to enhance pouch performance

### USE

ENT, general

Item No.	Dimensions	Pkg.
IDE2114	30.5 x 27.9 cm Adhesive only: 30.5 x 2.5 cm	10 ea/bx; 40 ea/cs

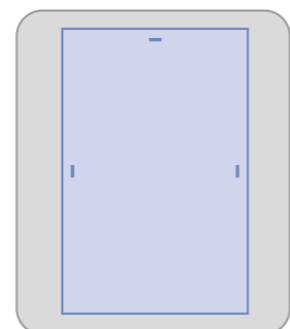

## SET UP COVERS

Item No.	Dimensions	Pkg.
ICE2158	46 x 61 cm, adhesive	40 ea/cs
ICE2008	137 x 229 cm	20 ea/cs
ICE35975	150 x 190 cm	40 ea/cs

# Orthopaedic Drapes

## POLY U DRAPES

### DESCRIPTION

- 'U' fenestration with wide adhesive area
- Advanced adhesive providing excellent adhesion without residue
- Strong, drapeable, low-glare matte-finish film
- Split, wax paper liner for ease of application

### USE

Prepping procedures: arthroscopies, hip, knee, shoulder, back, cranial, isolation and applications

Item No.	Dimensions	Pkg.
IDE1015	121 x 132 cm Adhesive only: 25 x 48 cm	10 ea/bx; 40 ea/cs
IDE1019	121 x 180 cm Adhesive only: 25 x 48 cm 'U' fenestration only: 15 x 48 cm	10 ea/bx; 40 ea/cs



These drapes include courtesy tabs for easy removal.

## SHOULDER POUCHES

### DESCRIPTION

- Oval aperture with slit and adhesive areas
- Strong adhesive with no residue
- Heavy, low-glare matte-finish film for additional strength
- 2 mouldable strips and 1 foam strip to enhance pouch performance
- 2 suction ports with caps for improved fluid control

### USE

Shoulder arthroscopy, implant applications

Item No.	Dimensions	Pkg.
IDE1067	91 x 73 cm Adhesive only: 25 x 48 cm Aperture: 19 x 25 cm	24 ea/cs

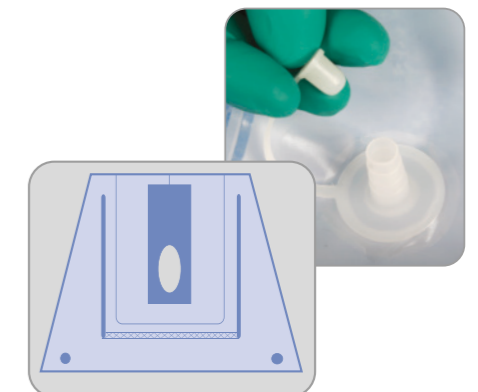

The capped, closable port eliminates the step of cutting or piercing for drainage and makes it easy to stop the flow at the end of the procedure.

# Orthopaedic Drapes

## U FLUID COLLECTION POUCHES

### DESCRIPTION

- 'U' aperture with adhesive area
- Strong adhesive with no residue
- 3 mouldable strips to enhance pouch performance
- Strong, drapeable, clear poly film

### USE

Shoulder arthroscopy, hip surgery, orthopaedic

Item No.	Dimensions	Pkg.
DYJPEFP090	76 x 112 cm Adhesive only: 25 x 51 cm Aperture: 15 x 46 cm	25 ea/cs

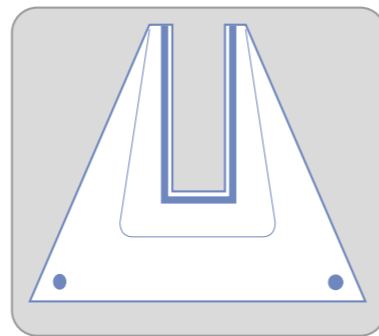

## PATIENT ISOLATION DRAPES

### DESCRIPTION

- Less aggressive adhesive strip for easy removal
- Aggressive incise adhesive with no residue
- Clear, strong poly film

### USE

Hip pinning

Item No.	Dimensions	Pkg.
IDE1014	317 x 213 cm Adhesive only: 49 x 25 cm Adhesive strip only: 317 x 1.3 cm	5 ea/bx; 15 ea/cs

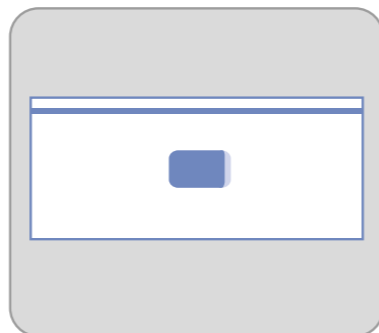

# Orthopaedic Drapes

## PATIENT ISOLATION DRAPES WITH POUCH

### DESCRIPTION

- Strong incise adhesive with no residue
- Clear, strong poly film
- 2 cord holders and instrument pouches for better organisation
- Large pouch with micro screen, suction port and cap for improved fluid control

### USE

Hip pinning, nephroscopies, biliaries

Item No.	Dimensions	Pkg.
IDE1017	317 x 213 cm Adhesive only: 49 x 25 cm Adhesive strip only: 317 x 1.3 cm Pouch only: 51 x 51 cm	15 ea/cs
IDE1017W	317 x 254 cm Adhesive only: 85.1 x 27.9 cm Adhesive strip only: 317 x 1.3 cm Pouch only: 69.9 x 94 cm	15 ea/cs

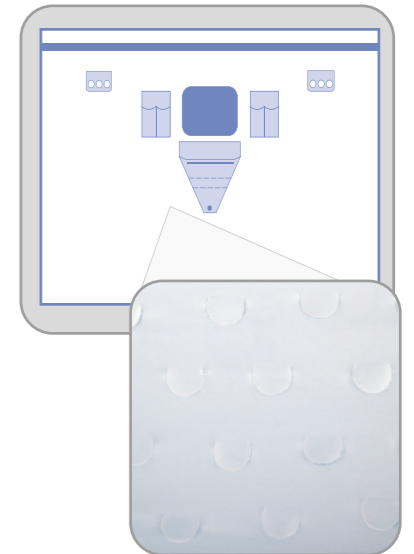

These drapes have a superb filter with deep placement for quick drainage and numerous small perforations.

# Ophthalmic Drapes

## APERTURE DRAPES

### DESCRIPTION

- Circular aperture with adhesive area
- Non-linting, tear-resistant, wax paper release liner
- Thin, soft, drapeable, low-glare matte-finish film

### USE

Cataract, corneal, refractive, lid/plastic, minor

Item No.	Dimensions	Pkg.
IDE1020	40 x 40 cm Adhesive only: 12 x 12 cm Aperture only: 6 cm circle	10 ea/bx; 40 ea/cs

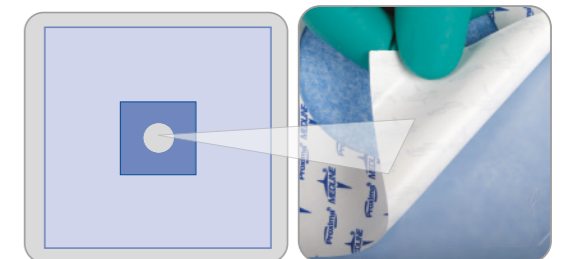

Easy-peel liner: less force is needed to separate it from the adhesive section.

## OPHTHALMIC DRAPES

### DESCRIPTION

- Incise adhesive area optimised for skin
- Non-linting, tear-resistant, wax paper release liner
- 2 adhesive tabs for additional support
- Mouldable strip for additional fluid control
- Soft, drapeable, low-glare matte-finish film

### USE

Cataract, vitreoretinal, corneal

Item No.	Dimensions	Pkg.
IDE1023	48 x 41 cm Adhesive only: 12 x 10 cm Adhesive tabs only: 5 x 5 cm	10 ea/bx; 40 ea/cs

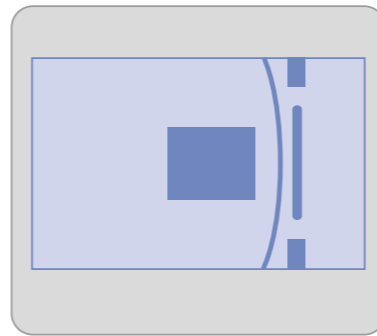

# Ophthalmic Drapes

## OPHTHALMIC APERTURE POUCHES

### DESCRIPTION

- Oval aperture with adhesive optimised for skin
- Non-linting, tear-resistant, wax paper release liner
- 2 adhesive tabs for additional support
- Mouldable strip for additional fluid control
- Soft, drapeable, low-glare matte-finish film

### USE

Cataract, vitreoretinal, corneal

Item No.	Dimensions	Pkg.
IDE1024	48 x 41 cm Adhesive only: 6 x 3.5 cm Adhesive tabs only: 5 x 5 cm Aperture only: 6 x 3.5 cm	10 ea/bx; 40 ea/cs

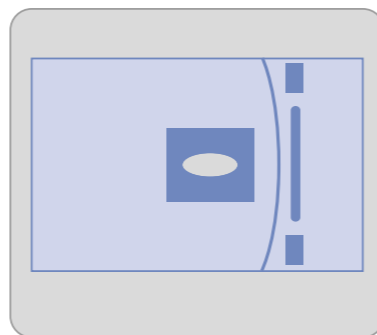

## APERTURE DRAPES

### DESCRIPTION

- Oval aperture with adhesive area
- Non-linting, tear-resistant, wax paper release liner
- Soft, drapeable, low-glare matte-finish film

### USE

Cataract, vitreoretinal, corneal, lid/plastic, ENT

Item No.	Dimensions	Pkg.
IDE1030	83 x 129 cm Adhesive only: 12 x 11 cm Aperture only: 7 x 5 cm	10 ea/bx; 40 ea/cs

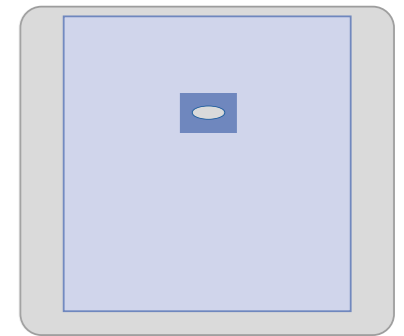

# Ophthalmic Drapes

## OPHTHALMIC INCISE DRAPES WITH FLUID POUCH

### DESCRIPTION

- Incise adhesive area
- Non-linting, tear-resistant, wax paper release liner
- Fluid pouch with mouldable strip for additional fluid control
- Soft, drapeable, low-glare matte-finish film

### USE

Cataract, vitreoretinal

Item No.	Dimensions	Pkg.
IDE1061	121 x 129 cm Adhesive only: 12 x 11 cm Pouch only: 30 x 27 cm	10 ea/bx; 40 ea/cs

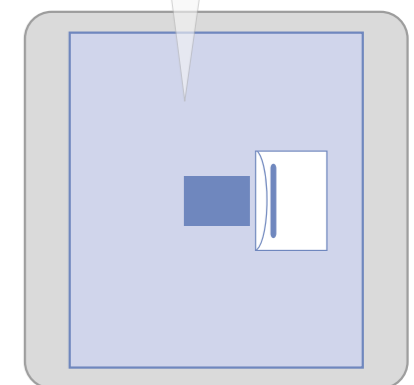
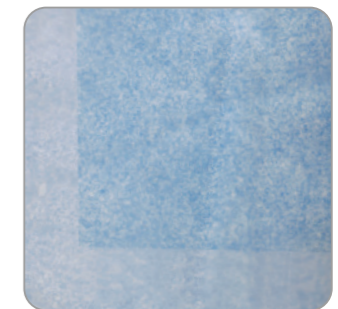

## UROLOGICAL DRAPES

### DESCRIPTION

- Strong adhesive with no residue
- Latex-free finger cot
- Strong, low-glare matte-finish film
- Non-linting, tear-resistant, wax paper release liner

### USE

TUR, urology, gynaecology

Item No.	Dimensions	Pkg.
IDE1071	60 x 91 cm Adhesive only: 60 x 5 cm Finger cot adhesive only: O.D. 10 x I.D. 3 cm	10 ea/bx; 40 ea/cs

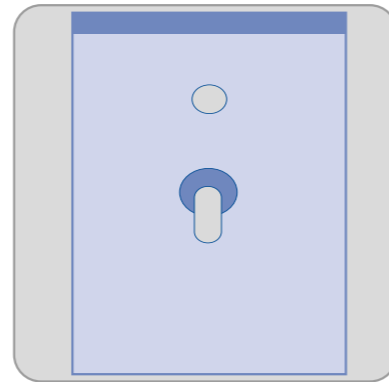

## Other Drapes

### APERTURE POUCHES

#### DESCRIPTION

- Oval aperture with large adhesive area
- Strong adhesive with no residue
- Mouldable strip for additional fluid control
- Heavy, low-glare matte-finish film

#### USE

Vaginal, ophthalmic

Item No.	Dimensions	Pkg.
IDE1072	45 x 22 cm Adhesive only: 30 x 22 cm Aperture only: 11 x 9 cm	10 ea/bx; 40 ea/cs

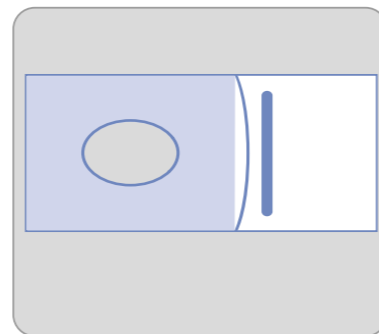

### CLEAR ADHESIVE DRAPE

Item No.	Dimensions	Pkg.
5810CE	150 x 300 cm	17 ea/cs

## CLEAR EPIDURAL DRAPES

Item No.	Dimensions	Pkg.
8461CE	60 x 100 cm, diameter 9 cm Adhesive fenestration	150 ea/cs
8465CE	80 x 140 cm, 6 x 10 cm Adhesive oval fenestration Pre-cut line for easy removal	30 ea/cs

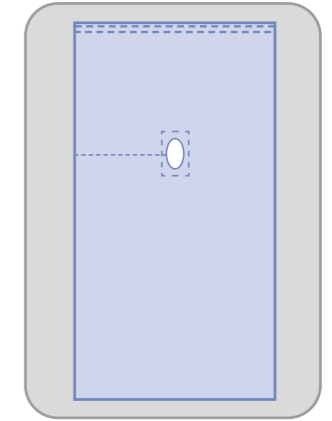

## CESAREAN POUCHES

### DESCRIPTION

- High-moisture permeable incise film for extended adhesion
- Strong adhesive with no residue
- Large-cell foam to provide fluid control
- 360° fluid pouch for complete fluid containment
- 2 cord holders for line organisation
- Heavy, low-glare matte-finish film for additional pouch strength

### USE

C-section, trauma, general

Item No.	Dimensions	Pkg.
IDE2057	91 x 76 cm Adhesive only: 38 x 36 cm	10 ea/cs

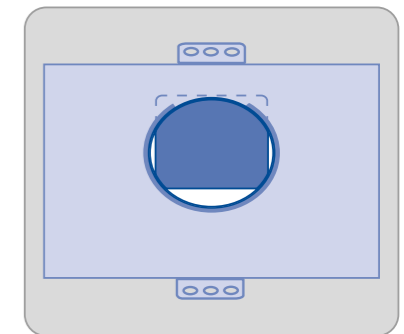

## WOUND RING PROTECTORS

### DESCRIPTION

- Strong, drapeable, low-glare matte-finish film
- 5 ring diameters to meet different surgical needs
- Application with adhesive tape

### USE

General, laparotomy, cardiothoracic, colectomy

Item No.	Dimensions	Pkg.
IDE3707	90 x 90 cm, ring diameter: 7 cm	40 ea/cs
IDE3712	90 x 90 cm, ring diameter: 12 cm	40 ea/cs
IDE3718	90 x 90 cm, ring diameter: 18 cm	40 ea/cs
IDE3723	90 x 90 cm, ring diameter: 23 cm	40 ea/cs
IDE3728	90 x 90 cm, ring diameter: 28 cm	40 ea/cs

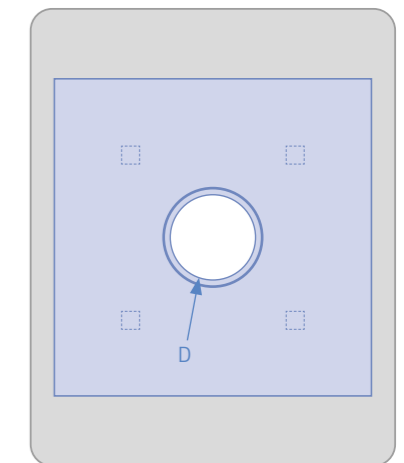

The wound ring protectors have a flexible but rigid ring at the fenestration site to help keep the drape in the correct position. The frosted clear plastic drape around the fenestration helps maintain the sterile barrier.

# Dermadine® and Dermadrape® Incise Drapes

## DESCRIPTION

- Thin, conformable, low-glare matte-finish film
- Strong adhesive with no residue
- Breathable, water-repellent and waterproof
- Comfortable and enveloping
- Long-lasting incise drapes
- Dermadine incise drapes: impregnated with an antibacterial solution
- Dermadrape drapes: clear incise drapes

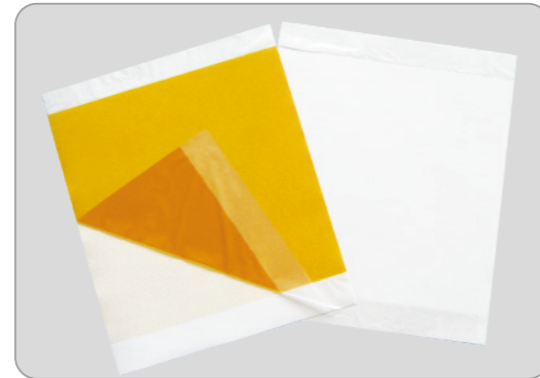

Dermadine® Item No.		Dimensions	Pkg.	Dermadrape® Item No.	
42020		20 x 20 cm Adhesive: 15 x 20 cm	20 ea/bx 120 ea/cs	32020	
n/a		35 x 25 cm Adhesive: 30 x 25 cm	20 ea/bx 120 ea/cs	33525	
44040		40 x 40 cm Adhesive: 34 x 40 cm	15 ea/bx 90 ea/cs	34040	
n/a		50 x 48 cm Adhesive: 44 x 48 cm	15 ea/bx 90 ea/cs	35050	
47045		70 x 45 cm Adhesive: 60 x 45 cm	15 ea/bx 90 ea/cs	37045	
48060		80 x 60 cm Adhesive: 60 x 60 cm	10 ea/bx 60 ea/cs	38060	
48080		80 x 80 cm Adhesive: 70 x 80 cm	10 ea/bx 60 ea/cs	38080	

# Equipment Drapes

## CIRCULAR BANDED BAGS

### DESCRIPTION

- Clear, drapeable poly film
- Latex-free elastic bands
- Versatile, often used to cover intensifiers and other equipment

Item No.	Dimensions	Pkg.
ICE60020S	25 x 55 cm	25 ea/cs
ICE60028S	35 x 70 cm	25 ea/cs
ICE60030S	40 x 80 cm	25 ea/cs
ICE60040S	50 x 100 cm	25 ea/cs
ICE60050S	60 x 120 cm	25 ea/cs
ICEBBG070	65 x 130 cm	50 ea/cs
ICE60060S	70 x 165 cm	10 ea/cs

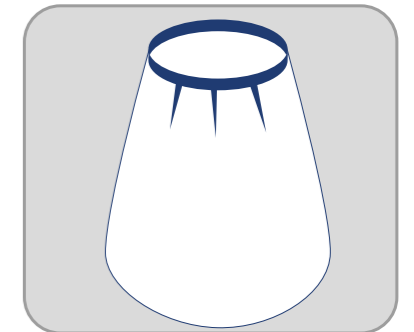

## RECTANGULAR BANDED BAGS

### DESCRIPTION

- Clear, drapeable poly film
- Latex-free elastic bands
- Versatile, often used to cover intensifiers and other equipment

Item No.	Dimensions	Pkg.
ICE63036R	76 x 91 cm	25 ea/cs
ICE63628R	91 x 71 cm	25 ea/cs
ICE63636R	91 x 91 cm	25 ea/cs
ICEBBG095	95 x 85 cm	25 ea/cs
ICE63654S	95 x 130 cm	25 ea/cs
ICE64848S	122 x 122 cm	25 ea/cs
ICE65656S	142 x 142 cm	25 ea/cs

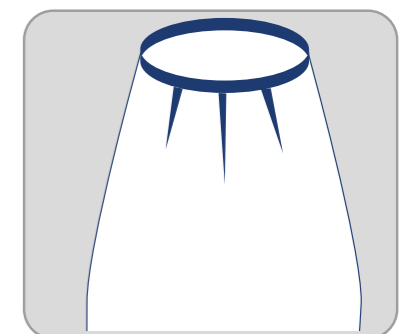



# Equipment Drapes

## C-ARM SET PHILIPS

### DESCRIPTION

- Clear banded bags for X-ray tank/intensifier
- Clear poly drape to cover the C-arm

DYNJE4526 for BV29/300  
 DYNJE4527 for BV300  
 DYNJE4530 for BV25/26  
 DYNJE4569 for Pulsera/Endura

Item No.	Dimensions	Pkg.
DYNJE4526	Banded bags: 60 x 115 cm   70 x 130 cm C-arm cover: 30 x 198 cm	10 ea/bx; 20 ea/cs
DYNJE4527	Banded bags: 60 x 115 cm   rect.: 95 x 85 cm C-arm cover: 30 x 198 cm	10 ea/bx; 20 ea/cs
DYNJE4530	Banded bags: 60 x 115 cm C-arm cover: 30 x 198 cm	10 ea/bx; 20 ea/cs
DYNJE4569	Banded bags: 60 x 115 cm   70 x 140 cm C-arm cover: 30 x 198 cm	10 ea/bx; 20 ea/cs

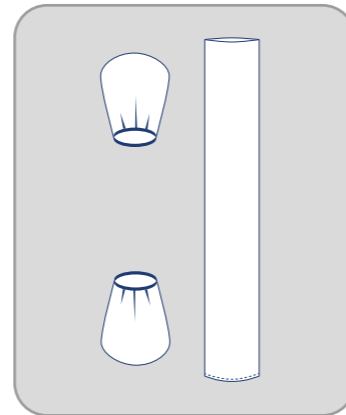

## C-ARM SET ZIEHM

### DESCRIPTION

- Clear banded bags for X-ray tank/intensifier
- Clear poly drape to cover the C-arm

For starter set SPTE-SS634

Item No.	Dimensions	Pkg.
DYNJE4531	Banded bags: 60 x 115 cm   70 x 130 cm C-arm cover: 35 x 185 cm	10 ea/bx; 20 ea/cs

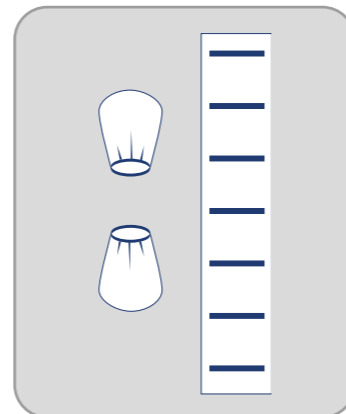

# Equipment Drapes

## C-ARM SET SIEMENS

### DESCRIPTION

- Clear banded bags for X-ray tank/intensifier
- Clear poly drape to cover the C-arm

DYNJE4532 for SIREMOBIL N4

- Clear poly drape with clips for starter set SPTE-SS628

DYNJE4556 for ISO-C/Arcadis/Orbic, 2 parts

Item No.	Dimensions	Pkg.
DYNJE4532	Banded bags: 60 x 115 cm   60 x 115 cm C-arm cover: 35 x 183 cm	10 ea/bx; 20 ea/cs
DYNJE4547	Banded bags: 70 x 130 cm   60 x 115 cm C-arm cover: 45 x 183 cm	20 ea/cs
DYNJE4556	Top: 51-82 x 130 cm Bottom: 53-46 x 134 cm	10 ea/bx; 20 ea/cs

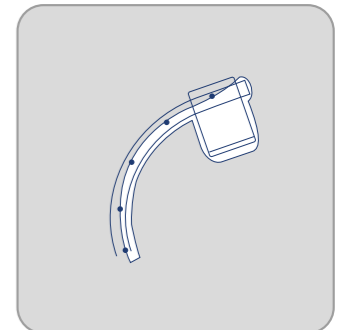
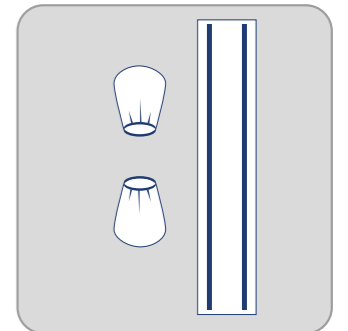

## FLUOROSCOPE DRAPES

### DESCRIPTION

- 2 adhesive strips for attachment, with 2 adhesive tabs for proper fit
- Clear, drapeable poly film

Item No.	Dimensions	Pkg.
ICE1012	91 x 111 cm Adhesive only (2): 91 x 1.2 cm Adhesive tabs only: 5 x 10 cm	10 ea/bx; 40 ea/cs

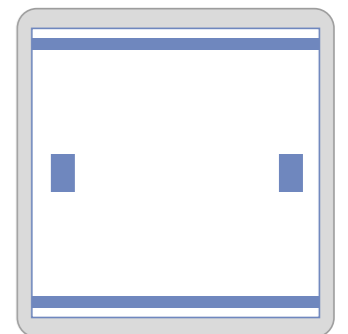

# Equipment Drapes

## FULL-SIZE C-ARM DRAPES

### DESCRIPTION

- 3 adhesive poly straps for securement
- Clear, drapeable poly film

ICE4400R: has 2 latex-free elastic bands for additional securement

Item No.	Dimensions	Pkg.
ICE4400	104 x 188 cm	20 ea/cs
ICE4400R	104 x 188 cm	20 ea/cs
ICE4405	90 x 225 cm	75 ea/cs

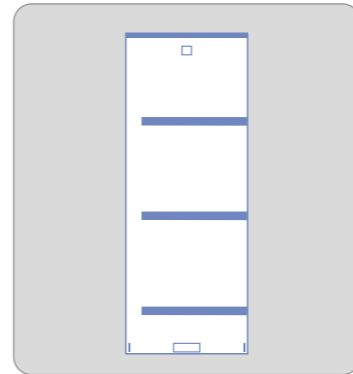

## CONTOURED C-ARM DRAPES

### DESCRIPTION

- 4 adhesive poly straps for securement
- Clear, drapeable poly film
- Contoured to fit full C-arm

Item No.	Dimensions	Pkg.
ICE4430	152 x 267 cm	20 ea/cs

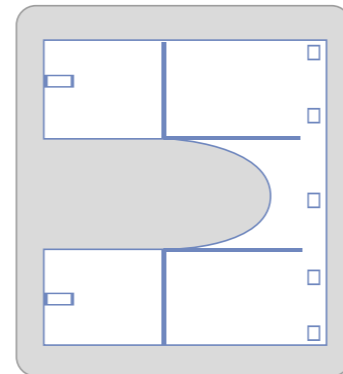

## MINI C-ARM DRAPES

### DESCRIPTION

- Held in place with an elastic band on the back
- 3 adhesive poly straps for additional securement
- Clear, drapeable poly film

ICE4410: fits Fluoroscan® mini C-arm models

ICE4420: fits Fluoroscan® and OEC6600/6800 mini C-arm models

Item No.	Dimensions	Pkg.
ICE4410	137 x 160 cm	20 ea/cs
ICE4420	137 x 216 cm	20 ea/cs

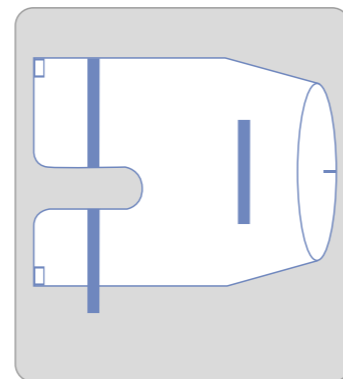

# Equipment Drapes

## FULL-SIZE C-ARM KITS

### DESCRIPTION

- Clear, drapeable poly film
- Latex-free bands

Item No.	Dimensions	Pkg.
ICE4500	Intensifier drape (1): 91 x 91 cm C-Arm drape (1): 41 x 218 cm Footswitch drape (1): 46 x 41 cm Banded bag (1): 71 x 31 cm	20 ea/cs
ICE8130	C-Arm drape (1): 10/14 x 225 cm Banded bag (2): 75 x 90 cm	20 ea/cs
ICE8132	C-Arm drape (1): 10/14 x 225 cm Banded bag (1): 75 x 90 cm	20 ea/cs
ICE8230	C-Arm drape (1): 8/10 x 205 cm Banded bag (2): 75 x 75 cm	20 ea/cs
ICE8232	C-Arm drape (1): 8/10 x 205 cm Banded bag (1): 75 x 75 cm	20 ea/cs
ICE8330	C-Arm drape (1): 8/10 x 180 cm Banded bag (2): 75 x 75 cm	20 ea/cs
ICE8332	C-Arm drape (1): 8/10 x 180 cm Banded bag (1): 75 x 75 cm	20 ea/cs

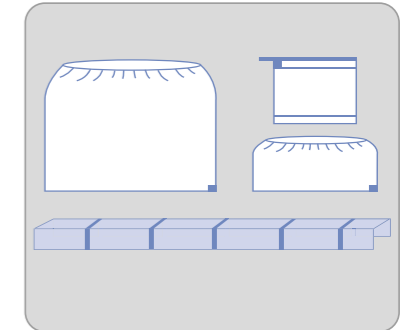

## REMOTE CONTROL COVERS

### DESCRIPTION

- Clear poly film bag
- Pinch-top closure

Item No.	Dimensions	Pkg.
DYNJE4635	10 x 28 cm	50 ea/bx; 200 ea/cs
DYNJE4641	18 x 35 cm	50 ea/bx; 200 ea/cs

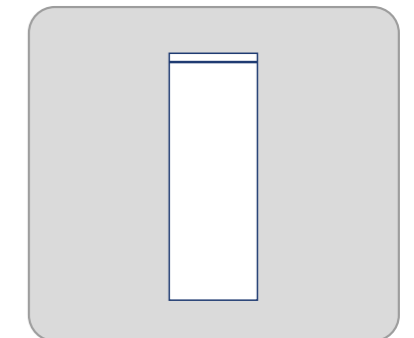

## VIDEO CAMERA COVERS

### DESCRIPTION

- Adhesive poly strap for holding it in place
- Adhesive strip at base for additional securement
- Clear, drapeable poly film
- Cable cover

Item No.	Dimensions	Pkg.
ICE4250	13 x 244 cm reverse	25 ea/cs
ICE4300	23 x 244 cm reverse	25 ea/cs
ICE4240	13 x 240 cm telescopic with tab	25 ea/cs
ICE4260	15 x 240 cm with ring	25 ea/cs
ICE4270	15 x 298 cm concertina	25 ea/cs
ICE4200	18 x 244 cm elastic end	25 ea/cs
ICE4100	8 x 200 cm telescopic with tab	25 ea/cs
ICE4245	18 x 250 cm telescopic with tab	25 ea/cs

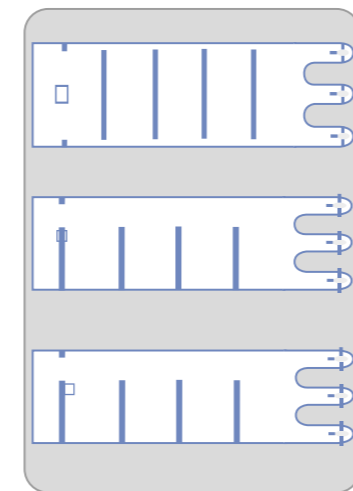
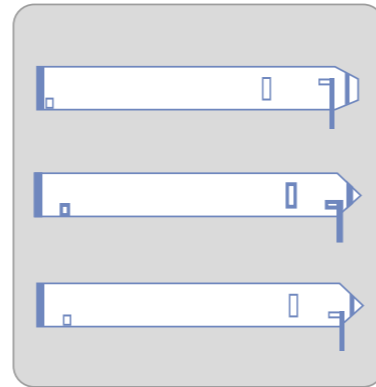

# Equipment Drapes

## MICROSCOPE DRAPES

### DESCRIPTION

- All fitted with clear, drapeable poly film

ICE5010, ICE5040

- Fits 48 mm lens (Zeiss® OPMI)
- 3 adhesive poly straps for securement
- Fits 1 pair of oculars

ICE5200, ICE5210, ICE5030

- Fits 65 mm lens (Zeiss® MD)
- 3 adhesive poly straps for securement
- Fits 3 pairs of oculars

ICE5220

- Fits 65 mm lens (Zeiss® MD)
- 5 adhesive poly straps for securement
- Fits 3 pairs of oculars

ICE5300, ICE5330

- Fits 68 mm lens (Leica®)
- 3 adhesive poly straps for securement
- Fits 3 pairs of oculars

Item No.	Dimensions	Pkg.
<b>Fits 48 mm lens (Zeiss® OPMI)</b>		
ICE5010	51 x 163 cm	20 ea/cs
ICE5040	51 x 267 cm	40 ea/cs
ICE5020	104 x 305 cm	10 ea/cs
<b>Fits 65 mm lens (Zeiss® MD)</b>		
ICE5200	117 x 203 cm	10 ea/cs
ICE5030	117 x 305 cm	10 ea/cs
ICE5210	117 x 267 cm	10 ea/cs
ICE5220	137 x 381 cm	10 ea/cs
<b>Fits 68 mm lens (Leica®)</b>		
ICE5300	104 x 163 cm	10 ea/cs
ICE5320	137 x 267 cm	10 ea/cs
ICE5330	137 x 381 cm	10 ea/cs

# Equipment Drapes

## X-RAY CASSETTE COVERS

### DESCRIPTION

- Clear, drapeable poly film

ICE4010: release liner for facilitating sterile technique

Item No.	Dimensions	Pkg.
ICE4000	Large: 61 x 102 cm	20 ea/cs
ICE4010	Standard with liner: 61 x 64 cm	48 ea/cs
ICE4050	Standard: 61 x 64 cm	50 ea/cs

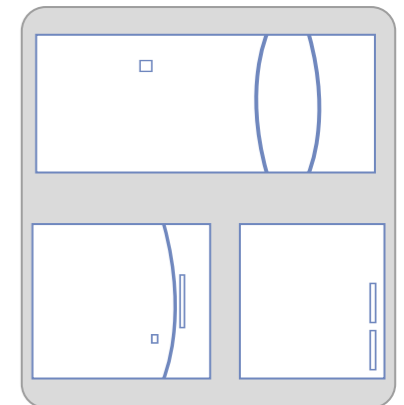

## PROBE COVER KITS

### DESCRIPTION

- 1 probe cover: soft and drapeable poly film
- 1 ultrasound gel packet: high-quality, sterile ultrasound gel for transducer
- 2 elastic bands for securement

Item No.	Dimensions	Pkg.
<b>Kits with gel</b>		
ICE5900	10 x 122 cm	20 ea/cs
ICE5910	15 x 61 cm	20 ea/cs
ICE5920	15 x 122 cm	20 ea/cs
ICE5930	15 x 244 cm	20 ea/cs
<b>Cover without gel</b>		
ICE18120	18 x 120 cm	25 ea/cs
ICE1830	18 x 30 cm	25 ea/cs
ICE1880	18 x 80 cm	25 ea/cs



High-quality polyurethane is soft and drapeable to conform to the transducer and has a smooth finish for easy application and glide. The slightly matte surface helps prevent glare.

## THERMO COVER

### DESCRIPTION

- Clear poly film
- Aluminium coated foil
- Temperature resistance up to 60° C

Item No.	Dimensions	Pkg.
DYNJE7000	68 x 86 cm	40 ea/cs

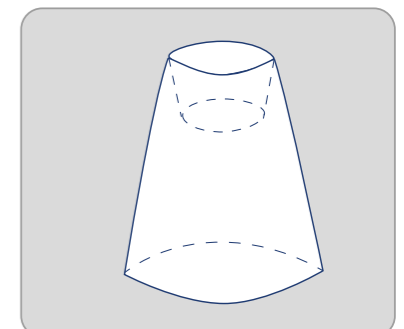

# INVISISHIELD Cross Reference

PAGE	DESCRIPTION	PRODUCT NO. MEDLINE	PRODUCT NO. 3M®	PRODUCT NO. MICROTEK®
3	Towel drape	IDE1000	1000	ISO1000
4	Isolation bag	ICE1003	1003	ISO1003
3	Towel drape	IDE1010	1010	ISO1010
8	Patient isolation drape	DYNJSD1014	1014	n/a
7	Poly U drape	IDE1015	1015	ISO1015
4	Fluid pouch	IDE1016	1016	ISO1016
9	Patient isolation drape	DYNJSD1017	1017	5960
9	Wide patient isolation drape	DYNJSD1017W	n/a	6960
5	Instrument pouch	IDE1018	1018	ISO1018
5	Long instrument pouch	IDE1018L	1018L	n/a
7	Poly U drape	IDE1019	1019	ISO1019
10	Aperture drape	IDE1020	1020	ISO1020
10	Ophthalmic incise drape	IDE1023	1023	n/a
11	Ophthalmic aperture pouch	IDE1024	1024	ISO1024
11	Aperture drape	IDE1030	1030	ISO1030
14	Incise drape	32020	1035	ISO1035
14	Incise drape	34040	1040	ISO1040
14	Incise drape	37045	1050	ISO1050
14	Incise drape	38080	1051	ISO1051
12	Ophthalmic incise drape with fluid pouch	IDE1061	1061	ISO1061
7	Shoulder pouch	DYNJSD1067	1067	ISO1067
12	Urological drape	IDE1071	1071	ISO1071
13	Aperture pouch	IDE1072	1072	ISO1072
8	U fluid collection pouch	DYJPEFP090	n/a	n/a
6	Instrument pouch	DYJPEISTPOM1	n/a	n/a
6	Instrument pouch	DYJPEISTPOM2	n/a	n/a
6	Instrument pouch	DYJPEISTPOM3	n/a	n/a



All products are latex free and sterile, unless indicated in the description.



Adhesive Matte film Poly film

# Dermadine® Cross Reference

TYPE OF FILM	DESCRIPTION	PRODUCT NO. MEDLINE	PRODUCT NO. 3M®
PU	Drape Incise Sterile 15 x 20 cm ~ Incise Area 10 x 20 cm Iodophor Impregnated	42020	6635
PU	Drape Incise Sterile 44 x 35 cm ~ Incise Area 34 x 35 cm Iodophor Impregnated	44040	6640
PU	Drape Incise Sterile 66 x 60 cm ~ Incise Area 56 x 60 cm Iodophor Impregnated	48060	6648
PU	Drape Incise Sterile 66 x 45 cm ~ Incise Area 56 x 45 cm Iodophor Impregnated	47045	6650
PU	Drape Incise Sterile 66 x 85 cm ~ Incise Area 56 x 85 cm Iodophor Impregnated	48080	6651
PU with applicator	Drape Incise Sterile 30 x 20 cm ~ Incise Area 26 x 20 cm Iodophor Impregnated	42020	6661EZ
PU with applicator	Drape Incise Sterile 60 x 35 cm ~ Incise Area 35 x 35 cm Iodophor Impregnated	44040	6640EZ
PU with applicator	Drape Incise Sterile 90 x 60 cm ~ Incise Area 60 x 60 cm Iodophor Impregnated	48060	6648EZ
PU with applicator	Drape Incise Sterile 90 x 45 cm ~ Incise Area 60 x 45 cm Iodophor Impregnated	47045	6650EZ
PU with applicator	Drape Incise Sterile 90 x 85 cm ~ Incise Area 60 x 85 cm Iodophor Impregnated	48080	6651EZ

# Dermadrape® Cross Reference

TYPE OF FILM	DESCRIPTION	PRODUCT NO. MEDLINE	PRODUCT NO. 3M®
PE	Drape Incise Sterile 15 x 20 cm ~ Incise Area 10 x 20 cm	32020	1035
PE	Drape Incise Sterile 29 x 25 cm ~ Incise Area 19 x 25 cm	32020	1037
PE	Drape Incise Sterile 60 x 35 cm ~ Incise Area 35 x 35 cm	34040	1040
PE	Drape Incise Sterile 82 x 45 cm ~ Incise Area 60 x 45 cm	37045	1050
PE	Drape Incise Sterile 82 x 85 cm ~ Incise Area 60 x 85 cm	38080	1051
PU	Drape Incise Sterile 20 x 20 cm ~ Incise Area 10 x 20 cm	32020	2035
PU	Drape Incise Sterile 38 x 25 cm ~ Incise Area 28 x 25 cm	33525	2037
PU	Drape Incise Sterile 38 x 41 cm ~ Incise Area 28 x 41 cm	34040	2040
PU	Drape Incise Sterile 60 x 45 cm ~ Incise Area 50 x 45 cm	35050	2045
PU	Drape Incise Sterile 90 x 60 cm ~ Incise Area 60 x 60 cm	38060	2050
PU	Drape Incise Sterile 90 x 85 cm ~ Incise Area 60 x 85 cm	38080	2051



For more information about our products please visit:  
[www.medline.eu/uk](http://www.medline.eu/uk) or contact your local account manager.



**ALWAYS  
ON.**

**Medline Industries Ltd**  
 3rd Floor  
 Quayside Wilderspool Business Park  
 Greenalls Avenue  
 Warrington WA4 6HL  
 United Kingdom  
 Tel.: +44 844 334 5237  
 Fax: +44 844 334 5238  
[www.medline.eu/uk](http://www.medline.eu/uk)  
[uk-customerservice@medline.com](mailto:uk-customerservice@medline.com)



Scan QR code for  
more information

Dermadine® and Dermadrape® are class IIa sterile medical devices.

Wound ring protectors are class IIa sterile medical devices.

All other products listed are class I sterile medical devices.

These products are intended to be used by healthcare professionals.  
 Before use, consult instructions and precautions on the corresponding labelling.

We reserve the right to correct any errors that may occur within this brochure.

© 2020 Medline Industries, Inc. Medline is a registered trademark of Medline Industries, Inc. Three Lakes Drive, Northfield, IL 60093, USA. ML164-EN 02/2020.

TIASET di Lorenzo Carresi  
 57100 Bolzello Km 5100  
 52026 Castellfranco-Piandisco (AR), Italy

Medline International France SAS  
 5, rue Charles Lindbergh  
 44110 Châteaubriant, France

Medline International France SAS  
 5, rue Charles Lindbergh  
 44110 Châteaubriant, France

CE 0373 Istituto Superiore di Sanità

CE 2797 (BSI)

CE 2797 (BSI)